

BOTTOM VIEW

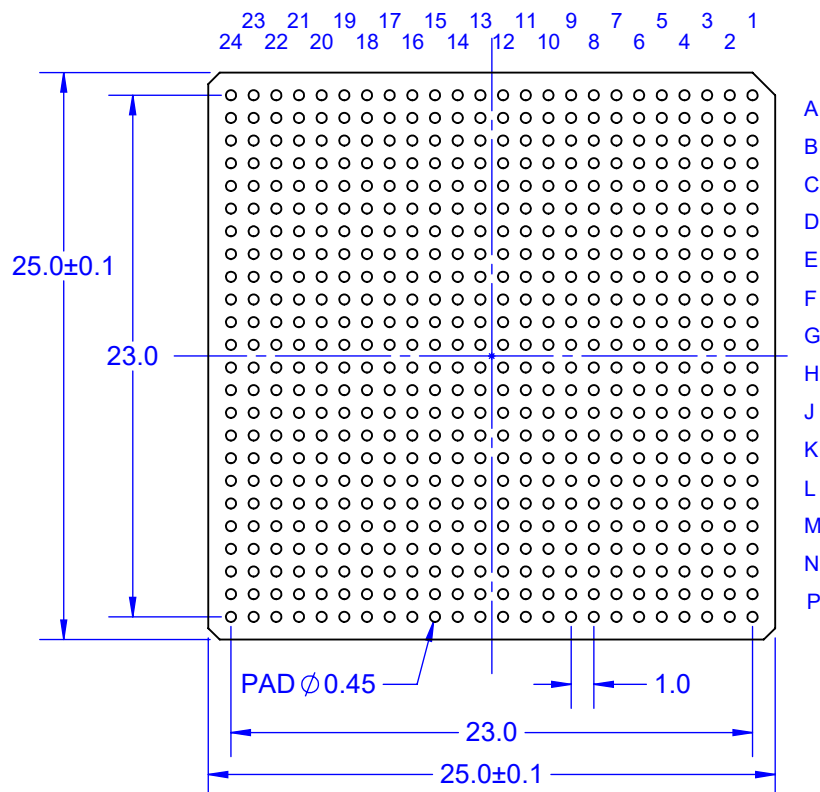

SIDE VIEW

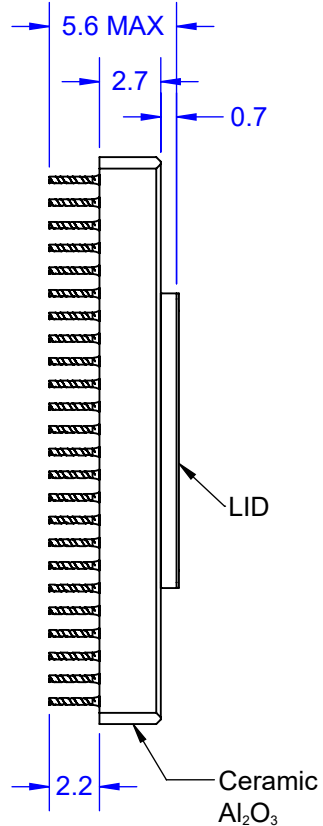

TOP VIEW

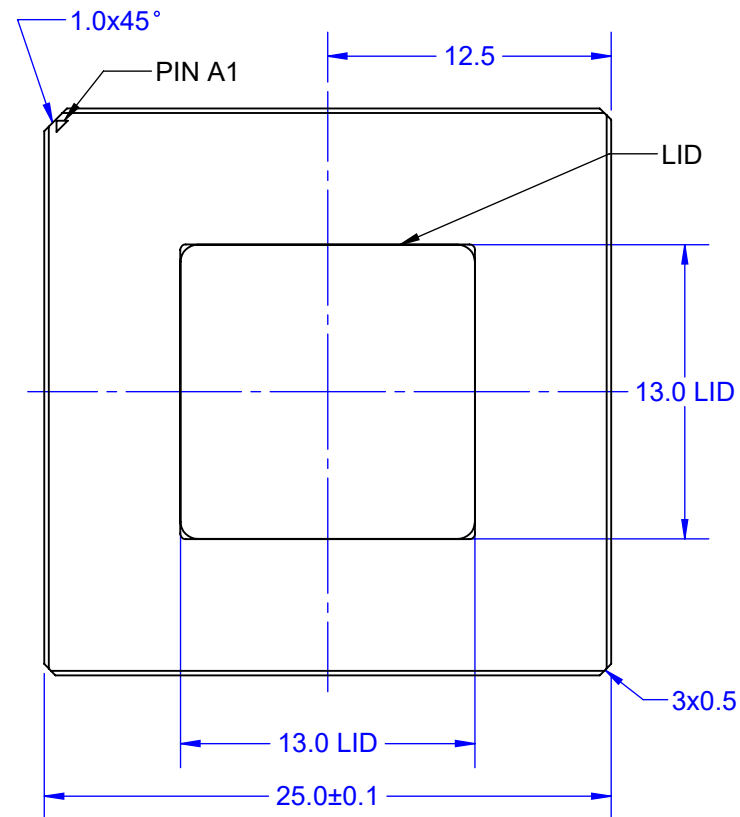

Pb80/Sn20
Cu RIBBON
COLUMNS

Notes: (Unless Otherwise Specified).

- 1) DIMENSIONS ARE IN mm.
- 2) SHOWN WITH COLUMNS.
- 3) SHOWN WITH LID COVER ATTACHED.

| | | | | | |
|-------------|------------|---|------|-------------|--------------|
| APPROVALS | DATE | TopLine® | | | |
| DRAWN T.Au | 12/21/2021 | | | | |
| ENG M. Hart | 12/21/2021 | TITLE CCGA576T1.0-24x24-RU COLUMN GRID ARRAY | | | |
| MFG | | SCALE | SIZE | DRAWING NO. | REV |
| QA | | 3:1 | A | 160066 | A |
| CUST | | DO NOT SCALE DRAWING | | | SHEET 1 OF 8 |
| REVISED | | | | | |

BOTTOM VIEW

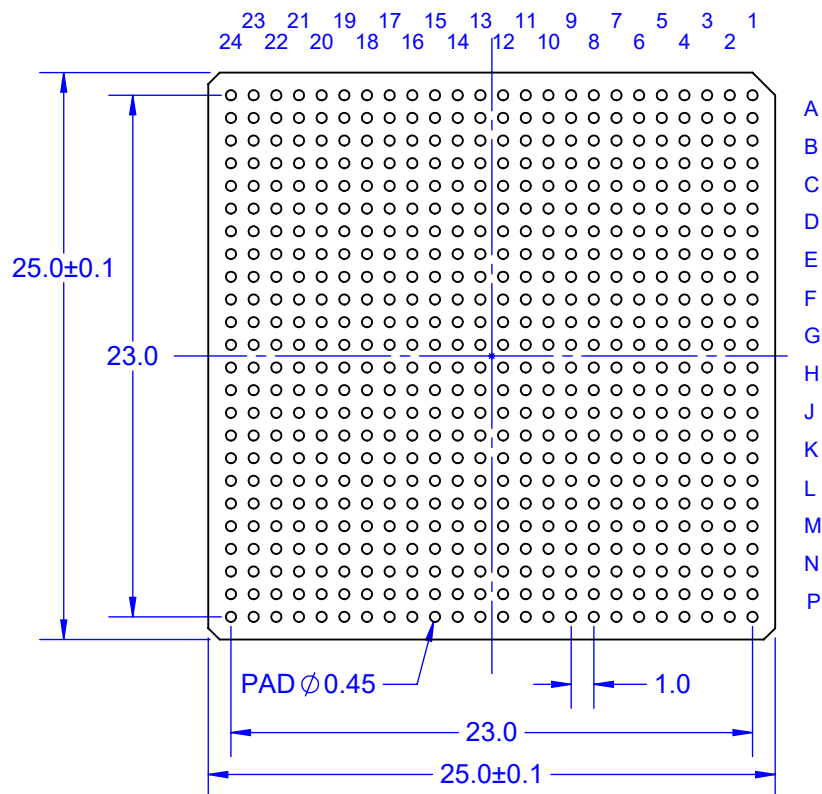

SIDE VIEW

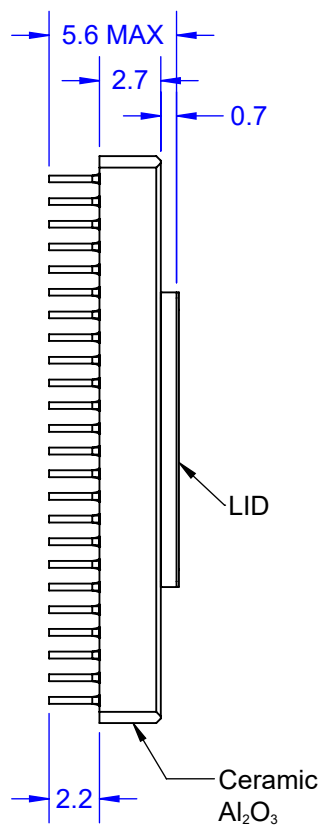

TOP VIEW

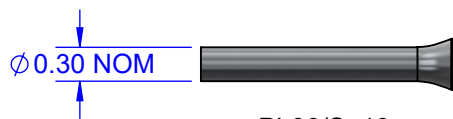
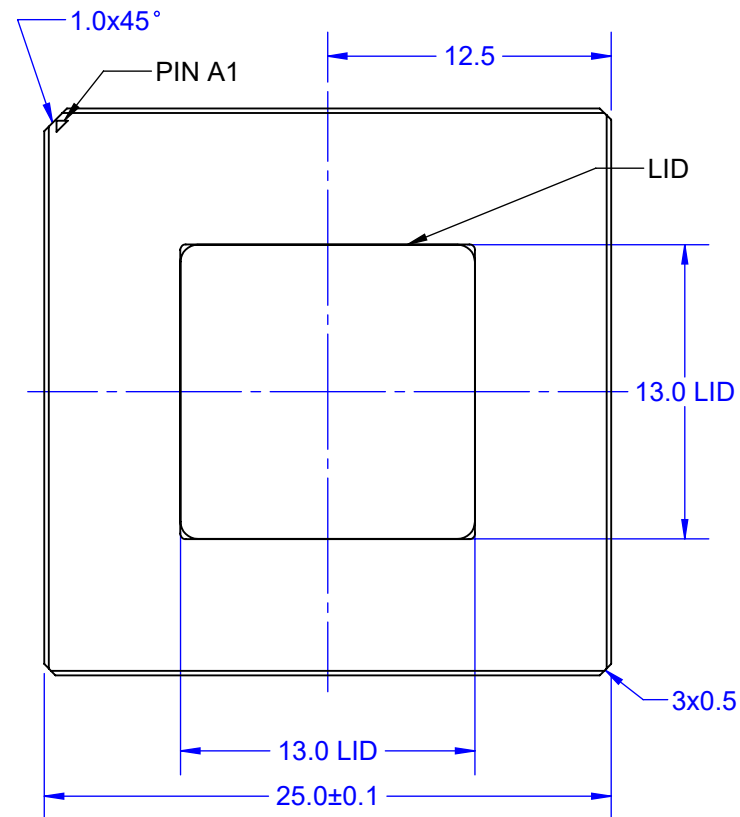

Pb90/Sn10
PLAIN
COLUMNS

Notes: (Unless Otherwise Specified).

- 1) DIMENSIONS ARE IN mm.
- 2) SHOWN WITH COLUMNS.
- 3) SHOWN WITH LID COVER ATTACHED.

| | | | | | |
|-------------|------------|---|------|-------------|--------------|
| APPROVALS | DATE | TopLine® | | | |
| DRAWN T.Au | 12/21/2021 | | | | |
| ENG M. Hart | 12/21/2021 | TITLE CCGA576T1.0-24x24-RU COLUMN GRID ARRAY | | | |
| MFG | | SCALE | SIZE | DRAWING NO. | REV |
| QA | | 3:1 | A | 160066 | A |
| CUST | | DO NOT SCALE DRAWING | | | SHEET 2 OF 8 |
| REVISED | | | | | |

BOTTOM VIEW

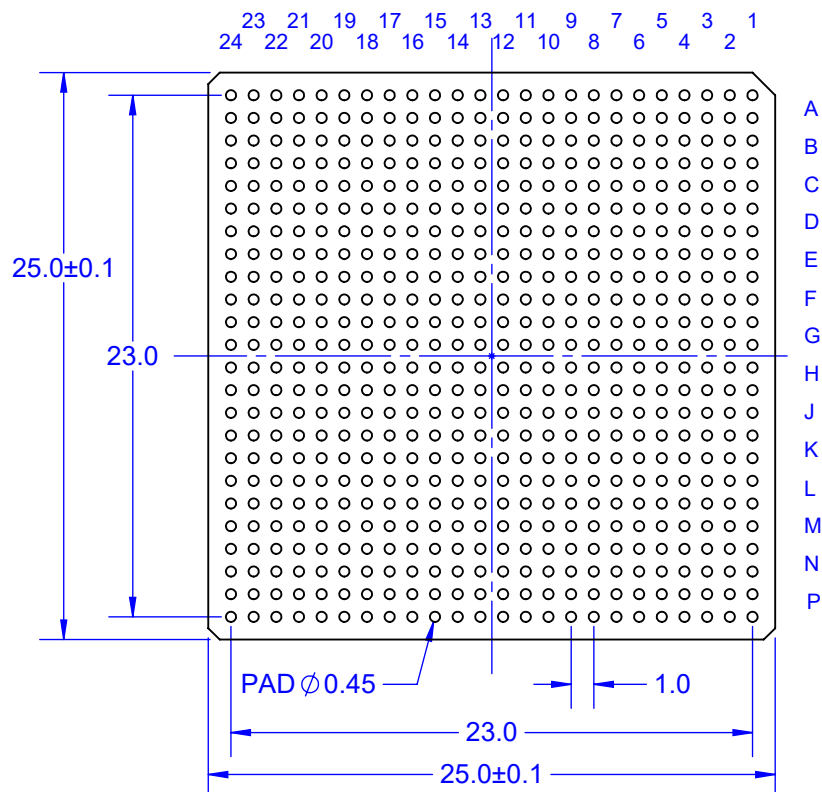

SIDE VIEW

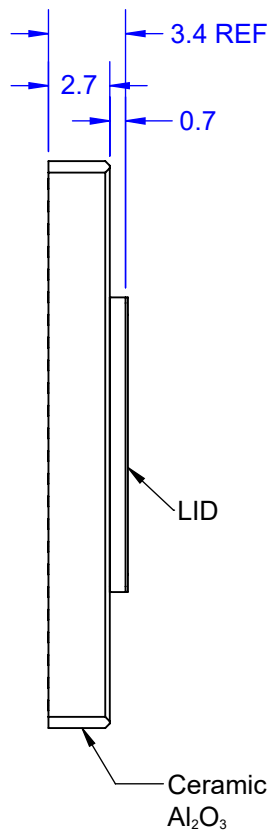

TOP VIEW

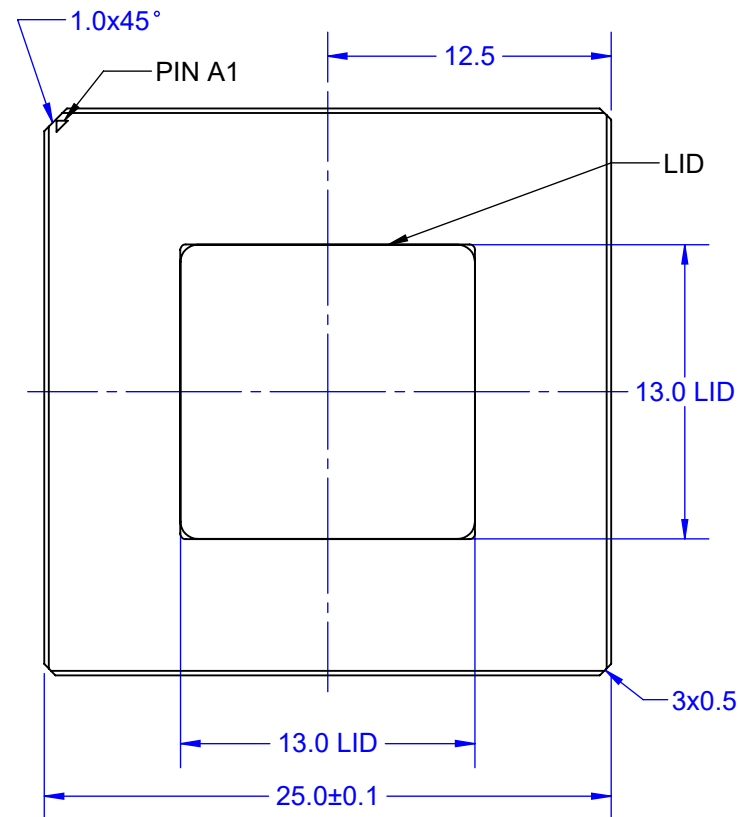

Notes: (Unless Otherwise Specified).

- 1) DIMENSIONS ARE IN mm.
- 2) SHOWN WITHOUT COLUMNS.
- 3) SHOWN WITH LID COVER ATTACHED.

| APPROVALS | | DATE |  | | | |
|-----------|---------|------------|---|------|-------------|--------------|
| DRAWN | T.Au | 12/21/2021 | | | | |
| ENG | M. Hart | 12/21/2021 | TITLE CCGA576T1.0-24x24-RU COLUMN GRID ARRAY | | | |
| MFG | | | | | | |
| QA | | | SCALE | SIZE | DRAWING NO. | REV |
| CUST | | | 3:1 | A | 160066 | A |
| REVISED | | | DO NOT SCALE DRAWING | | | SHEET 3 OF 8 |

PAD PATTERN

COLUMN (PAD) VIEW

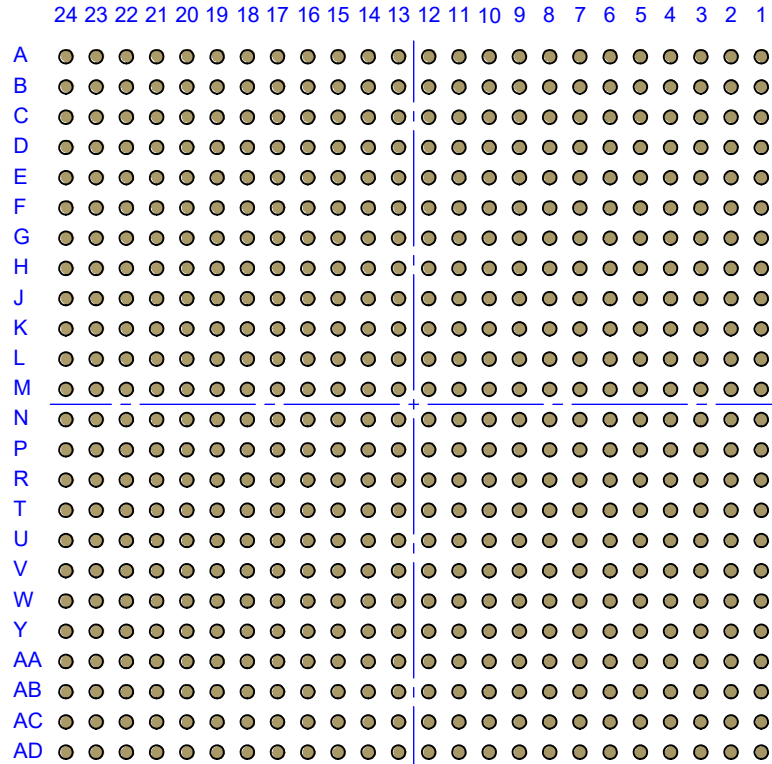

BOTTOM X-RAY VIEWED FROM TOP

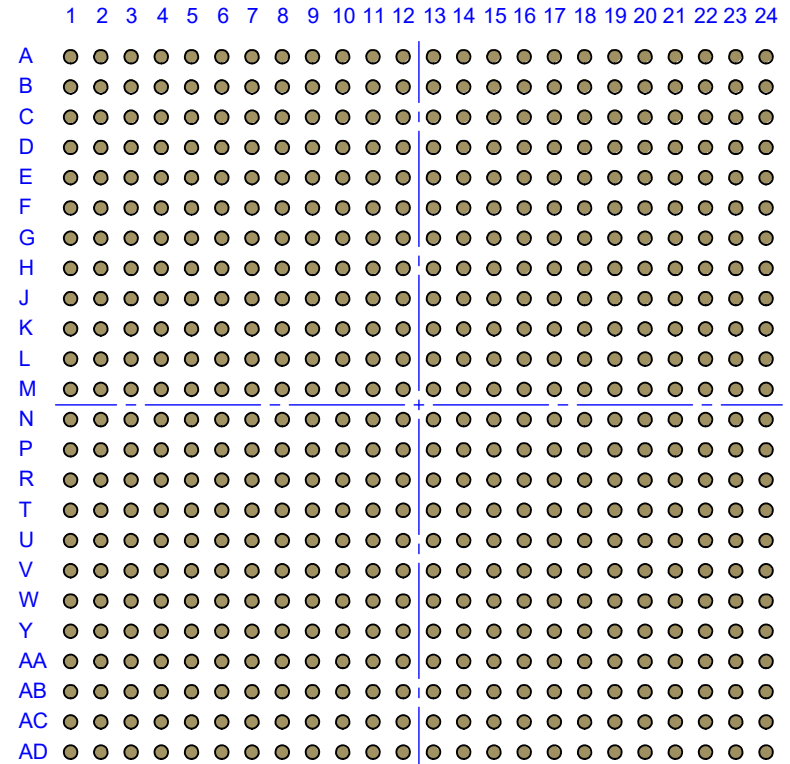

TopLine®

TITLE CCGA576T1.0-24x24-RU
COLUMN GRID ARRAY

| | | | |
|--------------|-----------|-----------------------|----------|
| SCALE 4:1 | SIZE A | DRAWING NO. 160066 | REV A |
|--------------|-----------|-----------------------|----------|

DO NOT SCALE DRAWING

SHEET 4 OF 8

SOLDER PIN OPTIONS

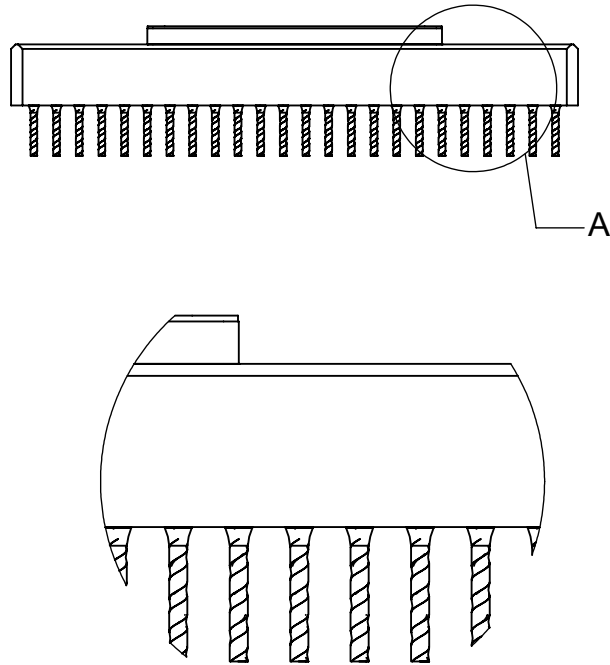

DETAIL A
SCALE 8 : 1

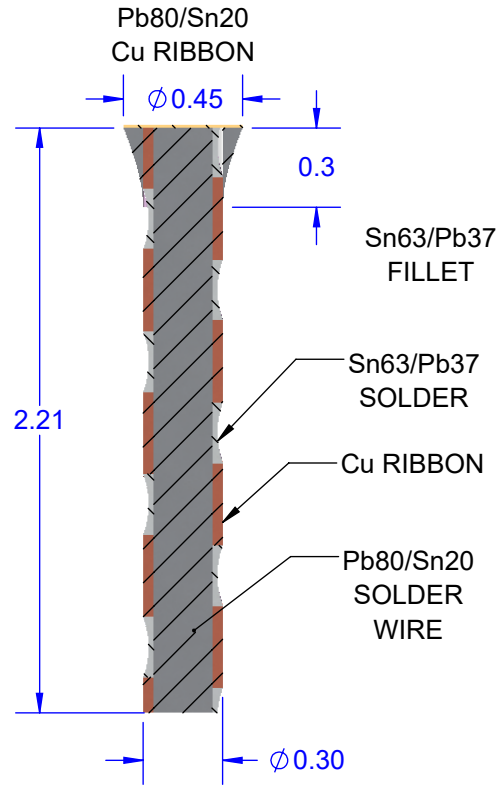

SECTION B-B
SCALE 35 : 1

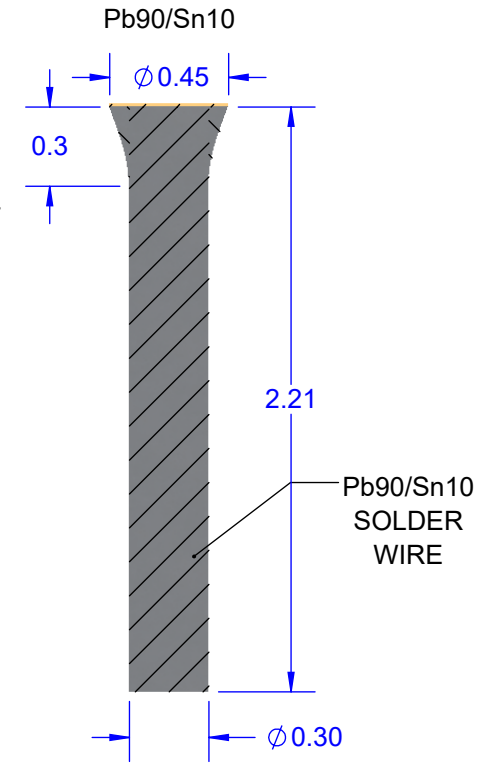

SECTION C-C
SCALE 35 : 1

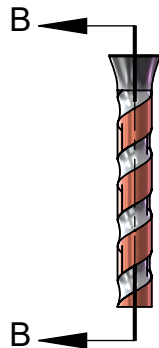

Pb80/Sn20
Cu RIBBON
SCALE 15:1

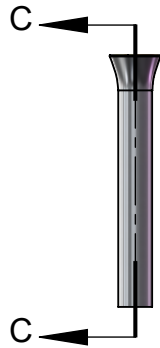

Pb90/Sn10
SCALE 15:1

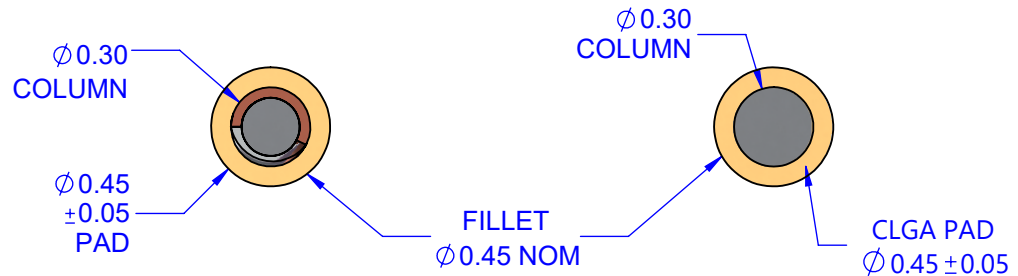

TopLine[®]

TITLE CCGA576T1.0-24x24-RU
COLUMN GRID ARRAY

| | | | |
|--------------|-----------|-----------------------|----------|
| SCALE 3:1 | SIZE A | DRAWING NO. 160066 | REV A |
|--------------|-----------|-----------------------|----------|

DO NOT SCALE DRAWING

SHEET 5 OF 8

**MODEL
CLGA576T1.0-24x24-RU
LID ATTACHED**

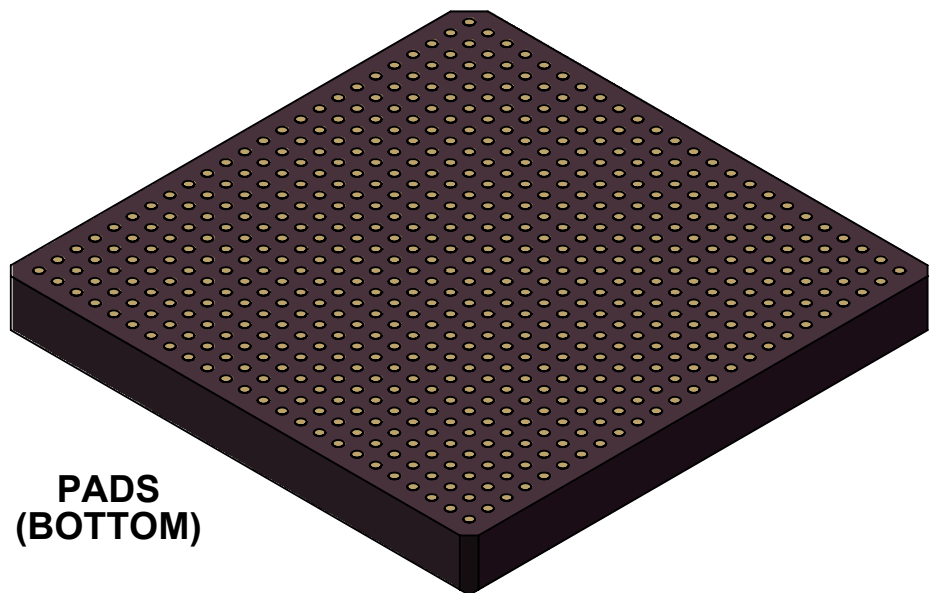

**PADS
(BOTTOM)**

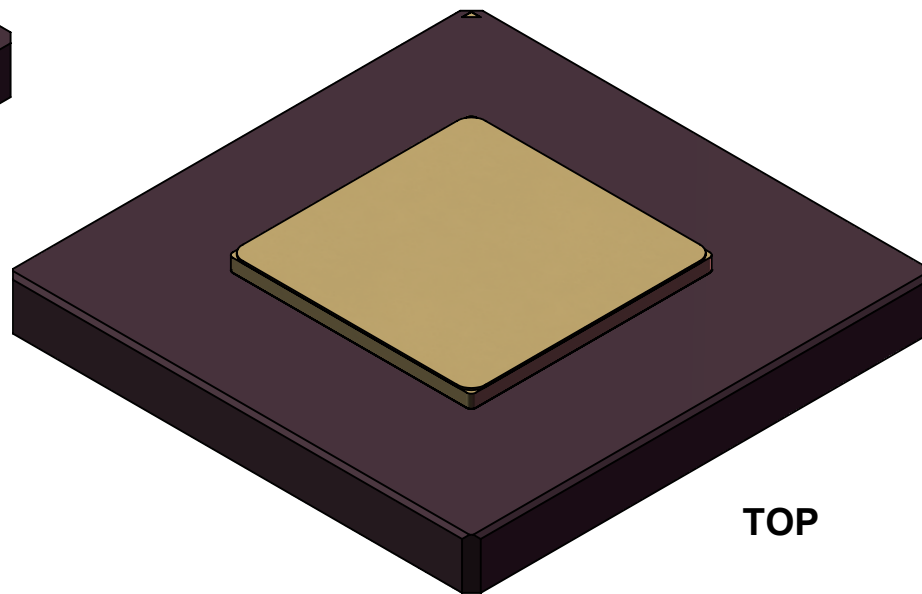

TOP

| | | | |
|---|-----------|-----------------------|--------------|
| TopLine® | | | |
| TITLE CCGA576T1.0-24x24-RU COLUMN GRID ARRAY | | | |
| SCALE 3.5:1 | SIZE A | DRAWING NO. 160066 | REV A |
| DO NOT SCALE DRAWING | | | SHEET 6 OF 8 |

MODEL
CCGA576T1.0-24x24-RU
Pb80/Sn20 COPPER WRAPPED
COLUMNS

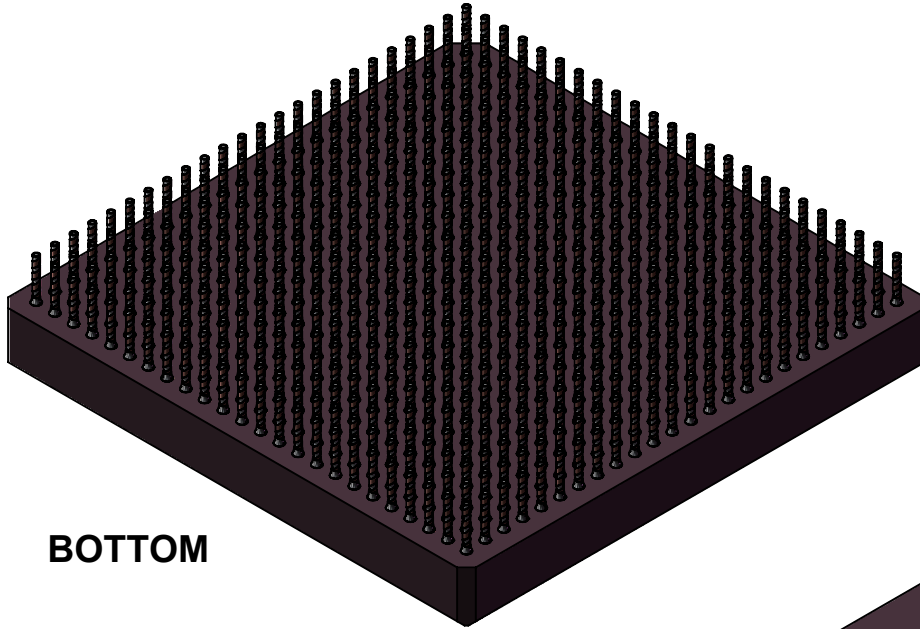

BOTTOM

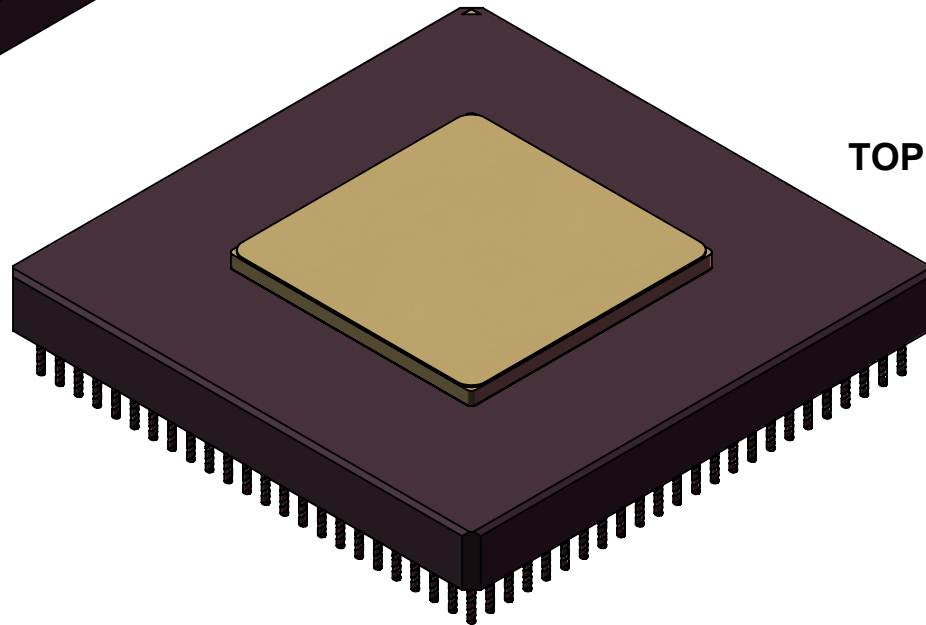

TOP

| | | | |
|---|-----------|-----------------------|--------------|
| TopLine [®] | | | |
| TITLE CCGA576T1.0-24x24-RU COLUMN GRID ARRAY | | | |
| SCALE 3.5:1 | SIZE A | DRAWING NO. 160066 | REV A |
| DO NOT SCALE DRAWING | | | SHEET 7 OF 8 |

MODEL
CCGA576T1.0A-24x24-RU
Pb90/Sn10 PLAIN COLUMNS

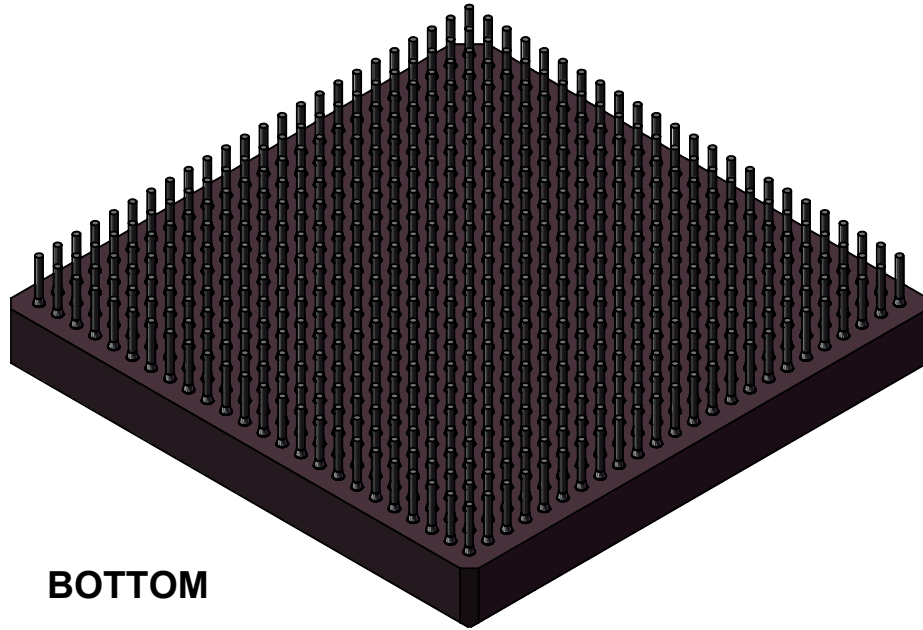

BOTTOM

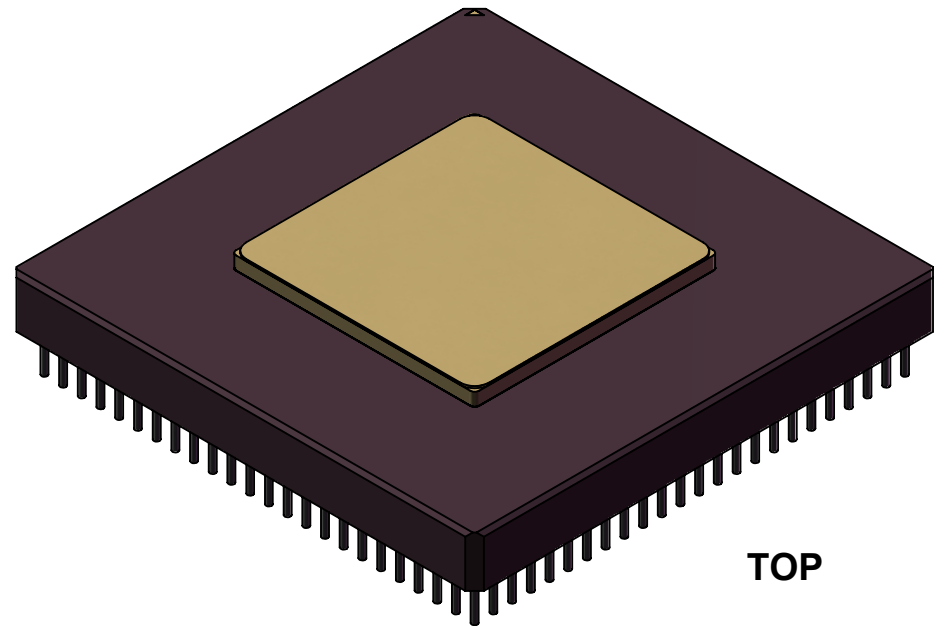

TOP

| | | | |
|---|-----------|-----------------------|--------------|
| TopLine[®] | | | |
| TITLE CCGA576T1.0-24x24-RU COLUMN GRID ARRAY | | | |
| SCALE 6:1 | SIZE A | DRAWING NO. 160066 | REV A |
| DO NOT SCALE DRAWING | | | SHEET 8 OF 8 |