

# 6CHCA J9K

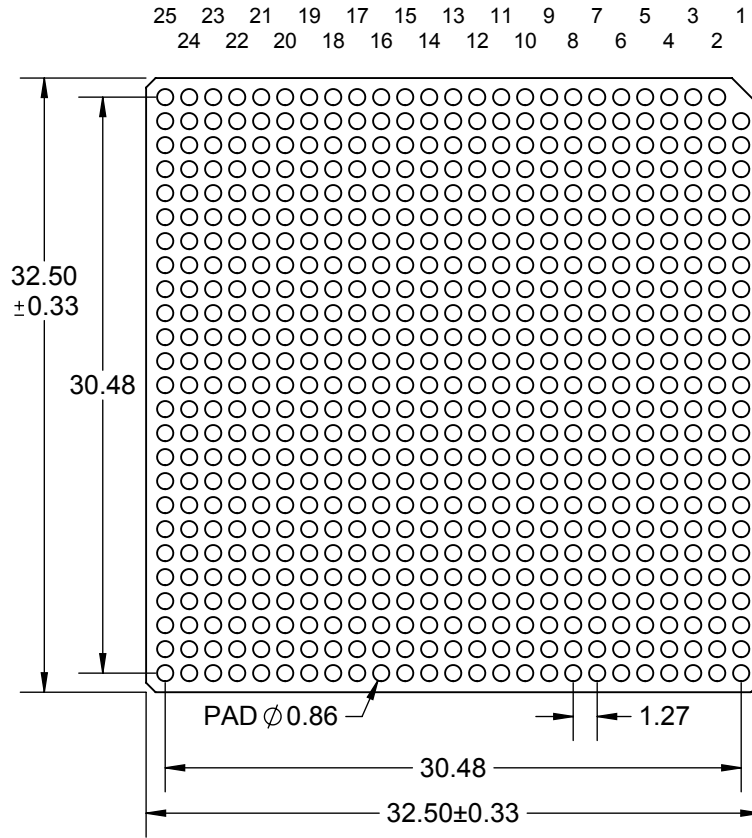

# G89 J9K

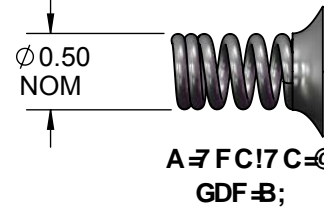
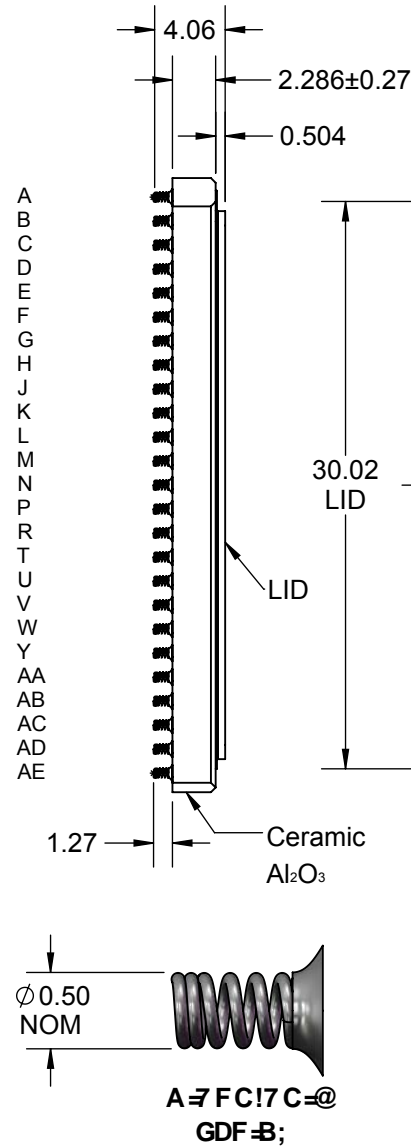

# HCD J9K

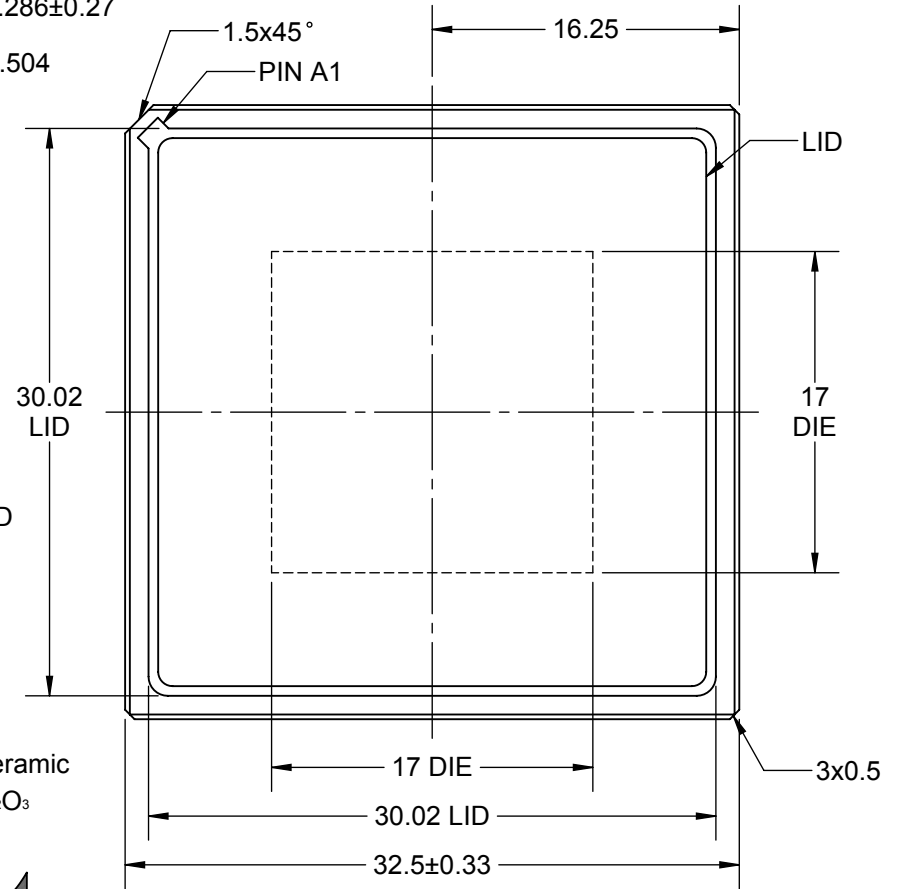

## NOTES:

1. PLATING TOP  
ELECTROLESS Ni 3.20~8.89µm (125~350 micro-inch).  
ELECTROLESS Au 2.5µm Min (100 micro-inch).

## 2. PLATING BOTTOM

ELECTROLESS Ni 3.20~8.89µm (125~350 micro-inch).  
ELECTROLESS Au 0.25µm Max (10 micro-inch).

## Notes: (Unless Otherwise Specified).

- 1) DIMENSIONS ARE IN mm.
- 2) SHOWN WITH COLUMNS.
- 3) SHOWN WITH LID COVER ATTACHED.
- 4) PART NUMBER CCGA624T1.27M-DC254D.

D5FHBI A69F CDHCBG			
D5FHBI A69F	8I AAM89	GC @9F D-B	@8
CCGA624T1.27M-DC254D	YES	YES	YES

APPROVALS	DATE				
DRAWN T.Au	12/23/2019				
ENG M. Hart	12/23/2019	TITLE CCGA624T1.27M-DC254D DUMMY COLUMN GRID ARRAY			
MFG		SCALE 2.5:1	SIZE A	DRAWING NO. 160054	REV A
QA		DO NOT SCALE DRAWING			SHEET 1 OF 5
CUST					
REVISED					

85 =GM7 < 5 =B'D5 HH9 FB

7C@ AB'fD5 8LJ=9K

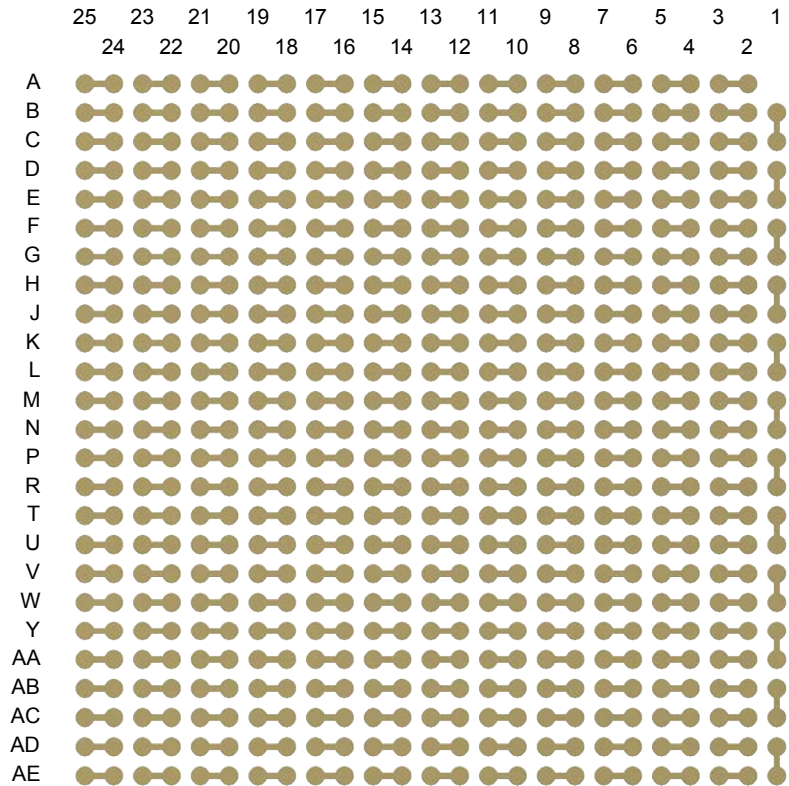

6CHCA'L!F5 MJ=9K 98': FCA'HCD

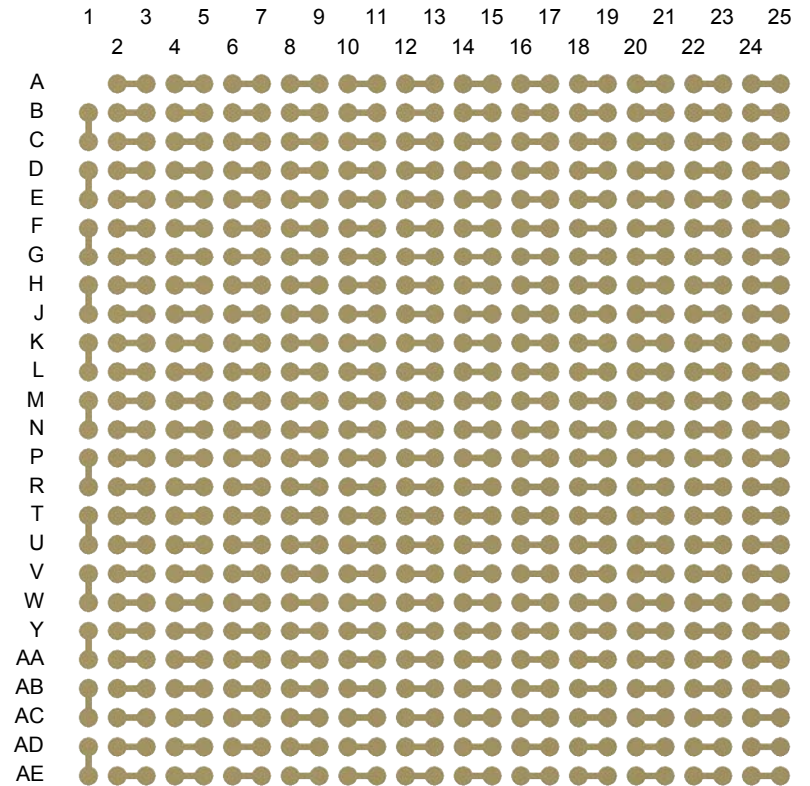

TITLE CCGA624T1.27M-DC254D  
DUMMY COLUMN GRID ARRAY

SCALE 2.5:1	SIZE A	DRAWING NO. 160054	REV A
----------------	-----------	-----------------------	----------

D-B	D-B	D-B	D-B	D-B	D-B	D-B	D-B	D-B	D-B	D-B	D-B	D-B	D-B
A2	A3	AC6	AC7	B8	B9	E12	E13	H14	H15	L18	L19	P20	P21
A4	A5	AC8	AC9	B10	B11	E14	E15	H16	H17	L20	L21	P22	P23
A6	A7	AC10	AC11	B12	B13	E16	E17	H18	H19	L22	L23	P24	P25
A8	A9	AC12	AC13	B14	B15	E18	E19	H20	H21	L24	L25	R2	R3
A10	A11	AC14	AC15	B16	B17	E20	E21	H22	H23	M1	N1	R4	R5
A12	A13	AC16	AC17	B18	B19	E22	E23	H24	H25	M2	M3	R6	R7
A15	A14	AC18	AC19	B20	B21	E24	E25	J2	J3	M4	M5	R8	R9
A17	A16	AC20	AC21	B22	B23	F1	G1	J4	J5	M6	M7	R10	R11
A19	A18	AC23	AC22	B24	B25	F2	F3	J6	J7	M8	M9	R12	R13
A20	A21	AC24	AC25	C2	C3	F4	F5	J8	J9	M10	M11	R14	R15
A22	A23	AD1	AE1	C4	C5	F6	F7	J10	J11	M12	M13	R16	R17
A24	A25	AD2	AD3	C6	C7	F8	F9	J12	J13	M14	M15	R18	R19
AA2	AA3	AD4	AD5	C8	C9	F10	F11	J14	J15	M16	M17	R20	R21
AA4	AA5	AD6	AD7	C10	C11	F12	F13	J16	J17	M18	M19	R22	R23
AA6	AA7	AD8	AD9	C12	C13	F14	F15	J18	J19	M20	M21	R24	R25
AA8	AA9	AD10	AD11	C14	C15	F16	F17	J20	J21	M22	M23	T1	U1
AA10	AA11	AD13	AD12	C16	C17	F18	F19	J22	J23	M24	M25	T2	T3
AA12	AA13	AD14	AD15	C18	C19	F20	F21	J24	J25	N2	N3	T4	T5
AA14	AA15	AD16	AD17	C20	C21	F22	F23	K1	L1	N4	N5	T6	T7
AA16	AA17	AD18	AD19	C22	C23	F24	F25	K2	K3	N6	N7	T8	T9
AA18	AA19	AD20	AD21	C24	C25	G2	G3	K4	K5	N8	N9	T10	T11
AA20	AA21	AD22	AD23	D1	E1	G4	G5	K6	K7	N10	N11	T12	T13
AA22	AA23	AD24	AD25	D2	D3	G6	G7	K8	K9	N12	N13	T14	T15
AA24	AA25	AE2	AE3	D4	D5	G8	G9	K10	K11	N14	N15	T16	T17
AB1	AC1	AE4	AE5	D6	D7	G10	G11	K12	K13	N16	N17	T18	T19
AB2	AB3	AE6	AE7	D8	D9	G12	G13	K14	K15	N18	N19	T20	T21
AB4	AB5	AE8	AE9	D10	D11	G14	G15	K16	K17	N20	N21	T22	T23
AB6	AB7	AE10	AE1	D12	D13	G16	G17	K18	K19	N22	N23	T24	T25
AB8	AB9	AE12	AE13	D14	D15	G18	G19	K20	K21	N24	N25	U2	U3
AB10	AB11	AE14	AE15	D16	D17	G20	G21	K22	K23	P1	R1	U4	U5
AB12	AB13	AE16	AE17	D18	D19	G22	G23	K24	K25	P2	P3	U6	U7
AB14	AB15	AE18	AE19	D20	D21	G24	G25	L2	L3	P4	P5	U8	U9
AB16	AB17	AE20	AE21	D22	D23	H1	J1	L4	L5	P6	P7	U10	U11
AB18	AB19	AE22	AE23	D24	D25	H2	H3	L6	L7	P8	P9	U12	U13
AB20	AB21	AE24	AE25	E2	E3	H4	H5	L8	L9	P10	P11	U14	U15
AB23	AB22	B1	C1	E4	E5	H6	H7	L10	L11	P12	P13	U16	U17
AB24	AB25	B2	B3	E6	E7	H8	H9	L12	L13	P14	P15	U18	U19
AC2	AC3	B4	B5	E8	E9	H10	H11	L14	L15	P16	P17	U20	U21
AC4	AC5	B6	B7	E10	E11	H12	H13	L16	L17	P18	P19	U22	U23

**B9H'@GH'85=GM7<5=B  
7CBB97H=CB'H56@**

D-B	D-B
U24	U25
V1	W1
V2	V3
V4	V5
V6	V7
V8	V9
V10	V11
V12	V13
V14	V15
V16	V17
V18	V19
V20	V21
V22	V23
V24	V25
W2	W3
W4	W5
W6	W7
W8	W9
W10	W11
W12	W13
W14	W15
W16	W17
W18	W19
W20	W21
W22	W23
W24	W25

D-B	D-B
Y1	AA1
Y2	Y3
Y4	Y5
Y6	Y7
Y8	Y9
Y10	Y11
Y12	Y13
Y14	Y15
Y16	Y17
Y18	Y19
Y20	Y21
Y22	Y23
Y24	Y25

<b>TopLine®</b>			
TITLE CCGA624T1.27M-DC254D DUMMY COLUMN GRID ARRAY			
SCALE NONE	SIZE A	DRAWING NO. 160054	REV A
DO NOT SCALE DRAWING			SHEET 3 OF 5

# GC @ 9F'D-B'CDH-CBG

Pb80/Sn20  
Cu RIBBON

Pb90/Sn10

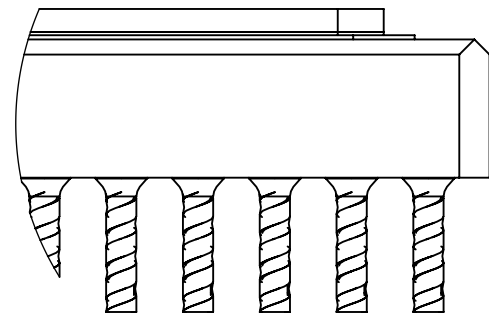
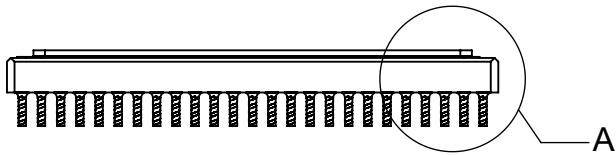

DETAIL A  
SCALE 8 : 1

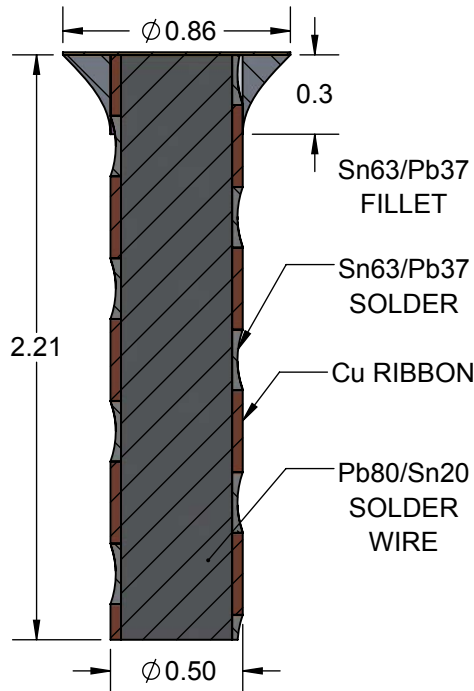

SECTION B-B  
SCALE 35 : 1



SECTION C-C  
SCALE 35 : 1

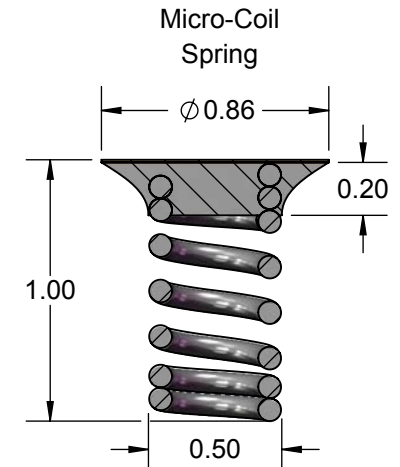

SECTION D-D  
SCALE 35 : 1

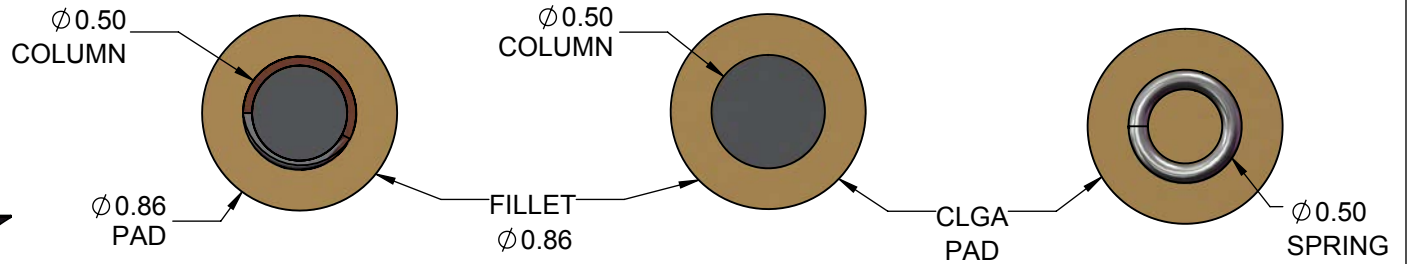
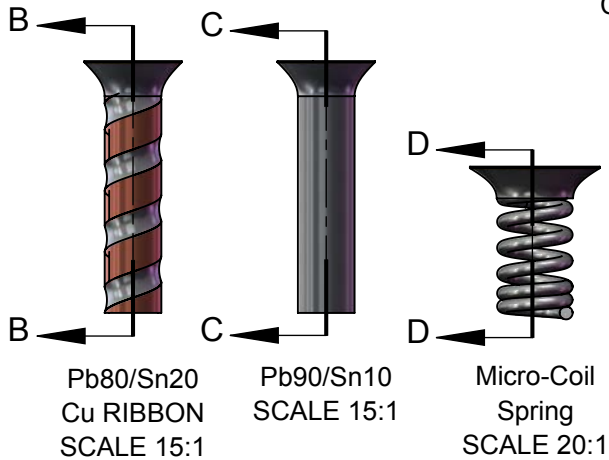

D5FHBI A69F'CDH-CBG		
D5FHBI A69F	8I AAM8-9	GC @ 9F'D-B
CCGA624T1.27-DC254D	YES	Pb80/Sn20 Cu RIBBON
CCGA624T1.27A-DC254D	YES	Pb90/Sn10
CCGA624T1.27M-DC254D	YES	Micro-Coil
CLGA624T1.27-DC254D	YES	NONE

TITLE CCGA624T1.27M-DC254D DUMMY COLUMN GRID ARRAY			
SCALE	SIZE	DRAWING NO.	REV
8:1	A	160054	A
DO NOT SCALE DRAWING			SHEET 4 OF 5

AC89 @  
77; 5 \* & (H%&+A!8 7 &) ( 8  
A 7 FC!7 C=@GDF-B; G

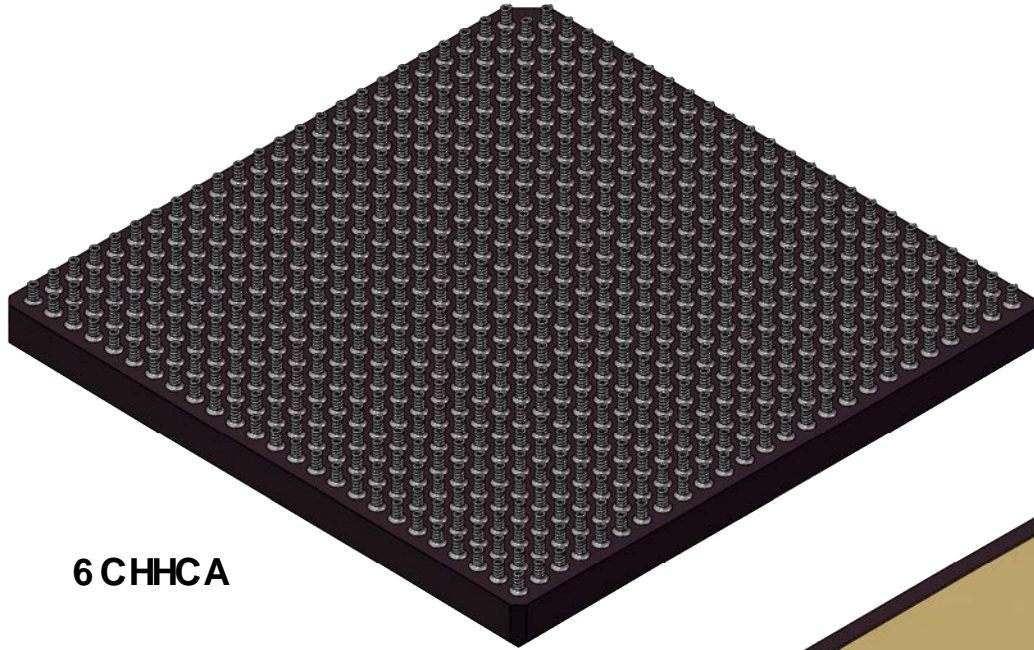

6 CHCA

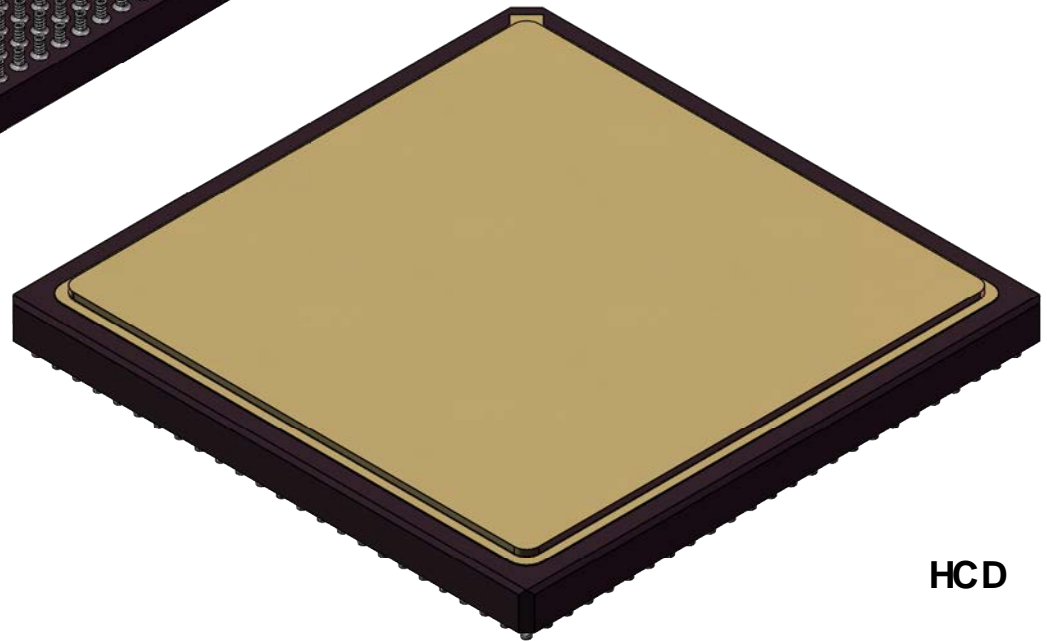

HCD

**TopLine**<sup>®</sup>

TITLE CCGA624T1.27M-DC254D  
DUMMY COLUMN GRID ARRAY

SCALE	SIZE	DRAWING NO.	REV
3:1	A	160054	A

DO NOT SCALE DRAWING

SHEET 5 OF 5