

### 6CHCA J9K

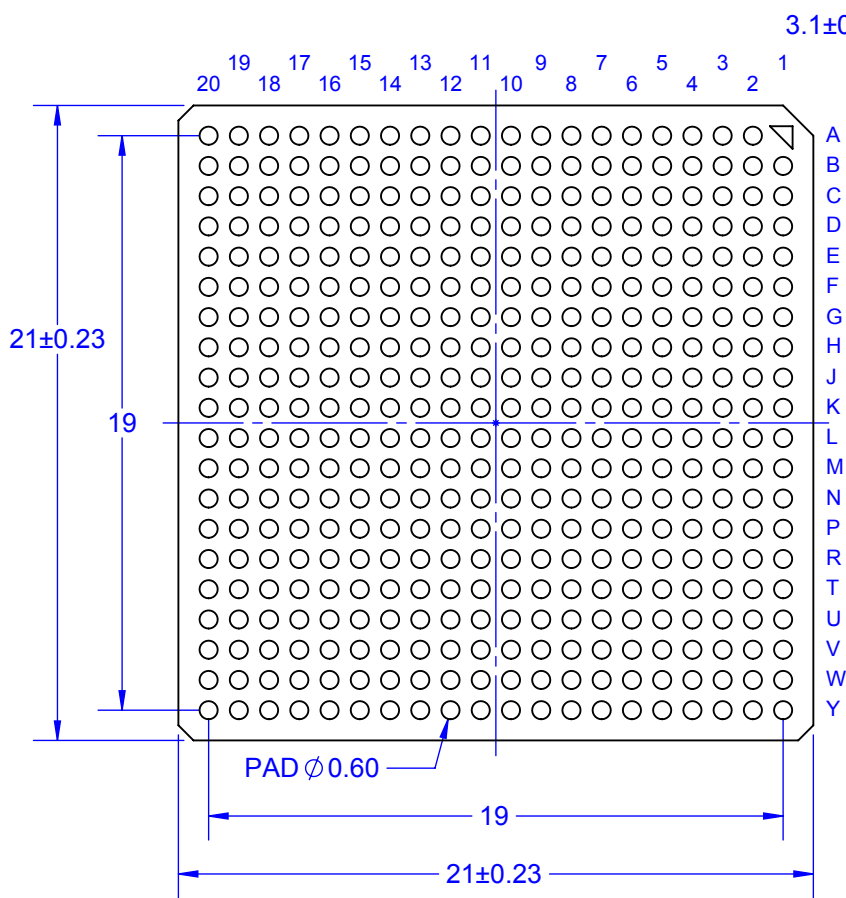

### G89 J9K

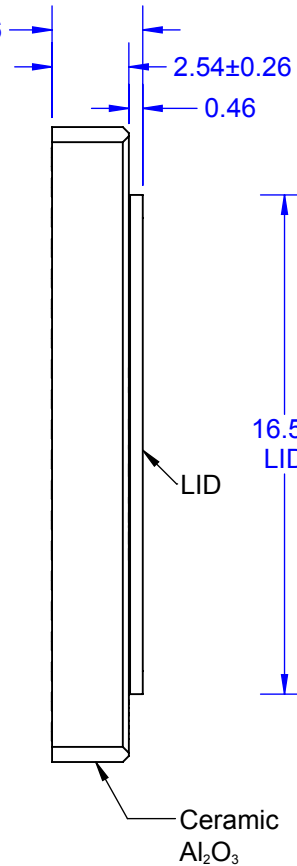

### HCD J9K

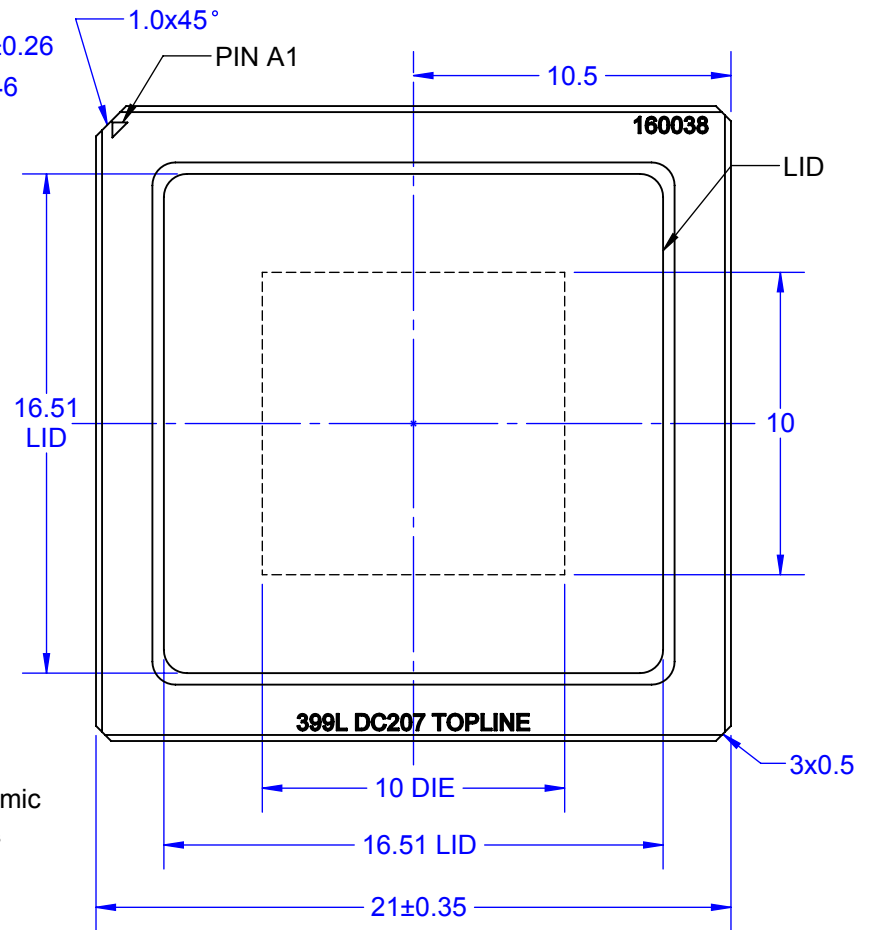

**NOTES:**

1. PLATING TOP  
ELECTROLESS Ni 3.20~8.89 μm (125~350 micro-inch).  
ELECTROLESS Au 1.5μm Min (60 micro-inch).

2. PLATING BOTTOM  
ELECTROLESS Ni 3.20~8.89 μm (125~350 micro-inch).  
ELECTROLESS Au 0.25μm Max (10 micro-inch).

**Notes: (Unless Otherwise Specified).**

- 1) DIMENSIONS ARE IN mm.
- 2) SHOWN WITHOUT COLUMNS.
- 3) SHOWN WITH LID COVER ATTACHED.
- 4) PART NUMBER CLGA399T1.0-DC207D.

<b>D5FH'BI A69F'CDHCBG</b>			
<b>D5FH'BI A69F</b>	<b>8I AAM8 9</b>	<b>GC @9F'D-B</b>	<b>@8</b>
CLGA399T1.0-DC207D	YES	NONE	YES

APPROVALS	DATE	<b>TopLine®</b>			
DRAWN T.Au	4/1/2019				
ENG M. Hart	4/1/2019	TITLE CLGA399T1.0-DC207D DUMMY COLUMN GRID ARRAY			
MFG		SCALE	SIZE	DRAWING NO.	REV
QA		3:1	A	160038	A
CUST		DO NOT SCALE DRAWING			SHEET 1 OF 4
REVISED					

85 =GM7 <5 =B`D5 HH9FB

7C@ AB`fD58LJ=K

19 17 15 13 11 9 7 5 3 1  
20 18 16 14 12 10 8 6 4 2

A  
B  
C  
D  
E  
F  
G  
H  
J  
K  
L  
M  
N  
P  
R  
T  
U  
V  
W  
Y

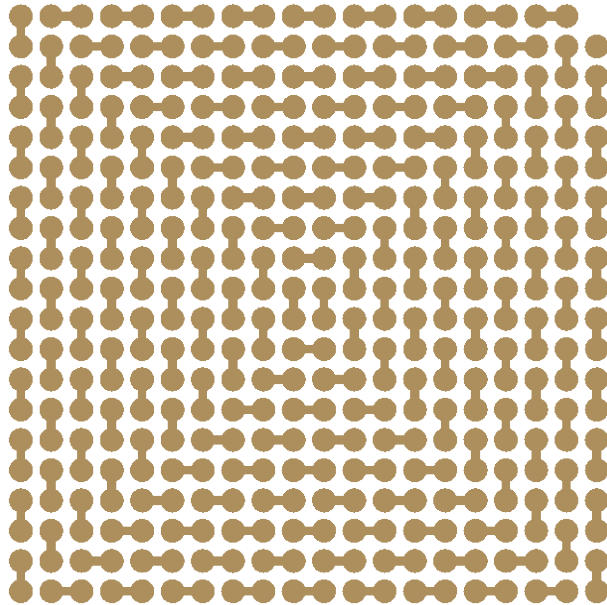

6CHCA`L!f5MJ=K98` : FCA`HCD

2 4 6 8 10 12 14 16 18 20  
1 3 5 7 9 11 13 15 17 19

A  
B  
C  
D  
E  
F  
G  
H  
J  
K  
L  
M  
N  
P  
R  
T  
U  
V  
W  
Y

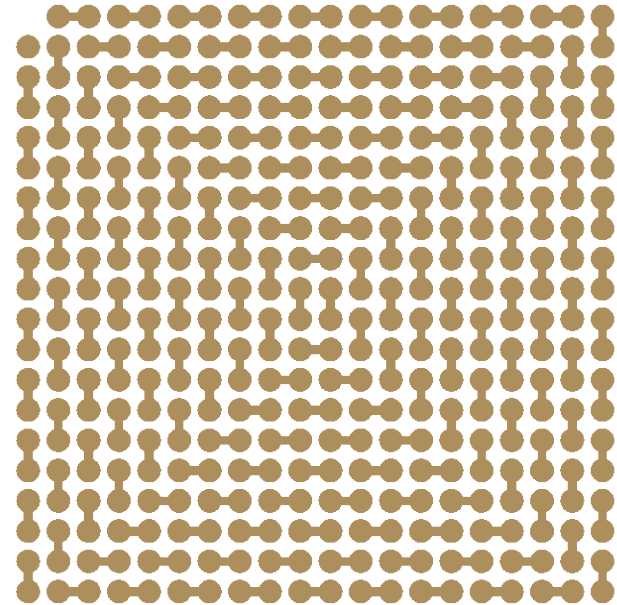

**TopLine®**

TITLE CLGA399T1.0-DC207D  
DUMMY COLUMN GRID ARRAY

SCALE 2.5:1	SIZE A	DRAWING NO. 160038	REV A
----------------	-----------	-----------------------	----------

DO NOT SCALE DRAWING

SHEET 2 OF 4

**B9H'@GH'85-GM7<5-B  
7CBB97H-CB'H56@**

87'D5-F	
A2	A3
A4	A5
A6	A7
A8	A9
A10	A11
A12	A13
A14	A15
A16	A17
A18	A19
A20	B20
B2	C2
B3	B4
B5	B6
B7	B8
B9	B10
B11	B12
B13	B14
B15	B16
B17	B18
B19	C19
C1	D1
C3	D3
C4	C5
C6	C7
C8	C9
C10	C11
C12	C13
C14	C15
C16	C17
C18	D18
C20	D20
D2	E2
D4	E4
D5	D6
D7	D8
D9	D10
D11	D12
D13	D14

87'D5-F	
D15	D16
D17	E17
D19	E19
E1	F1
E3	F3
E5	F5
E6	E7
E8	E9
E10	E11
E12	E13
E14	E15
E16	F16
E18	F18
E20	F20
F2	G2
F4	G4
F6	G6
F7	F8
F9	F10
F11	F12
F13	F14
F15	G15
F17	G17
F19	G19
G1	H1
G3	H3
G5	H5
G7	H7
G8	G9
G10	G11
G12	G13
G14	H14
G16	H16
G18	H18
G20	H20
H2	J2
H4	J4
H6	J6

87'D5-F	
H8	J8
H9	H10
H11	H12
H13	J13
H15	J15
H17	J17
H19	J19
J1	K1
J3	K3
J5	K5
J7	K7
J9	K9
J10	J11
J12	K12
J14	K14
J16	K16
J18	K18
J20	K20
K2	L2
K4	L4
K6	L6
K8	L8
K10	L10
K11	L11
K13	L13
K15	L15
K17	L17
K19	L19
L1	M1
L3	M3
L5	M5
L7	M7
L9	M9
L12	M12
L14	M14
L16	M16
L18	M18
L20	M20

87'D5-F	
M2	N2
M4	N4
M6	N6
M8	N8
M10	M11
M13	N13
M15	N15
M17	N17
M19	N19
N1	P1
N3	P3
N5	P5
N7	P7
N9	N10
N11	N12
N14	P14
N16	P16
N18	P18
N20	P20
P2	R2
P4	R4
P6	R6
P8	P9
P10	P11
P12	P13
P15	R15
P17	R17
P19	R19
R1	T1
R3	T3
R5	T5
R7	R8
R9	R10
R11	R12
R13	R14
R16	T16
R18	T18
R20	T20

87'D5-F	
T2	U2
T4	U4
T6	T7
T8	T9
T10	T11
T12	T13
T14	T15
T17	U17
T19	U19
U1	V1
U3	V3
U5	U6
U7	U8
U9	U10
U11	U12
U13	U14
U15	U16
U18	V18
U20	V20
V2	W2
V4	V5
V6	V7
V8	V9
V10	V11
V12	V13
V14	V15
V16	V17
V19	W19
W1	Y1
W3	W4
W5	W6
W7	W8
W9	W10
W11	W12
W13	W14
W15	W16
W17	W18
W20	Y20

87'D5-F	
Y2	Y3
Y4	Y5
Y6	Y7
Y8	Y9
Y10	Y11
Y12	Y13
Y14	Y15
Y16	Y17
Y18	Y19

B7	
A1	
B1	

B7	
D/A	
S/R	

			
TITLE CLGA399T1.0-DC207D DUMMY COLUMN GRID ARRAY			
SCALE NONE	SIZE A	DRAWING NO. 160038	REV A
DO NOT SCALE DRAWING		SHEET 3 OF 4	

AC89@  
 7 @ 5' -- H%\$!87 &\$+8  
 @8 #7 CJ9F '5 HH57 <98

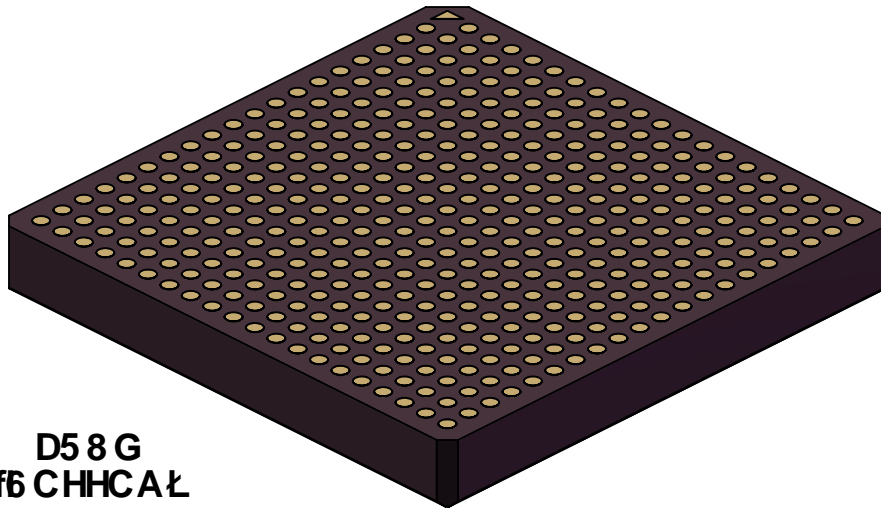

D5 8 G  
 f6 CHHCAŁ

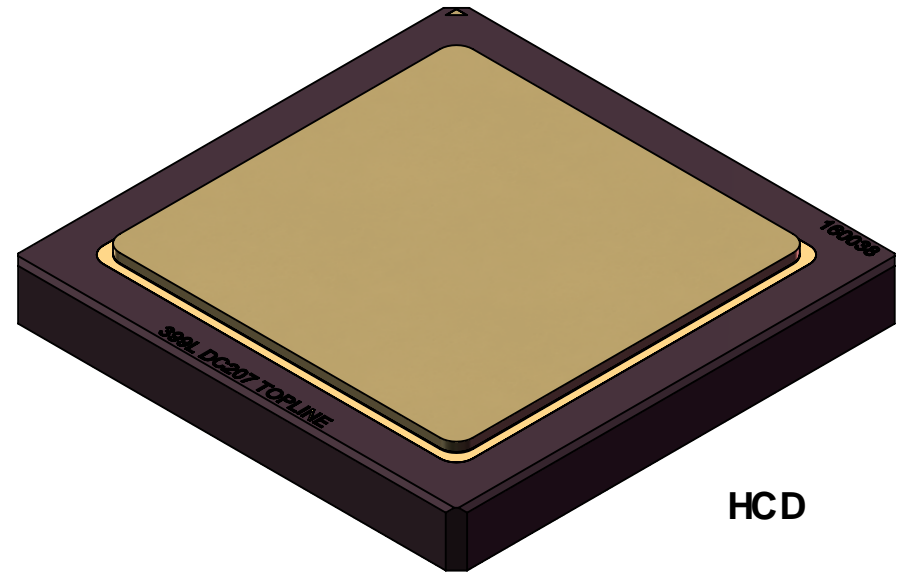

HCD

<b>TopLine®</b>			
TITLE CLGA399T1.0-DC207D DUMMY COLUMN GRID ARRAY			
SCALE 4:1	SIZE A	DRAWING NO. 160038	REV A
DO NOT SCALE DRAWING		SHEET 4 OF 4	