

### TOP VIEW

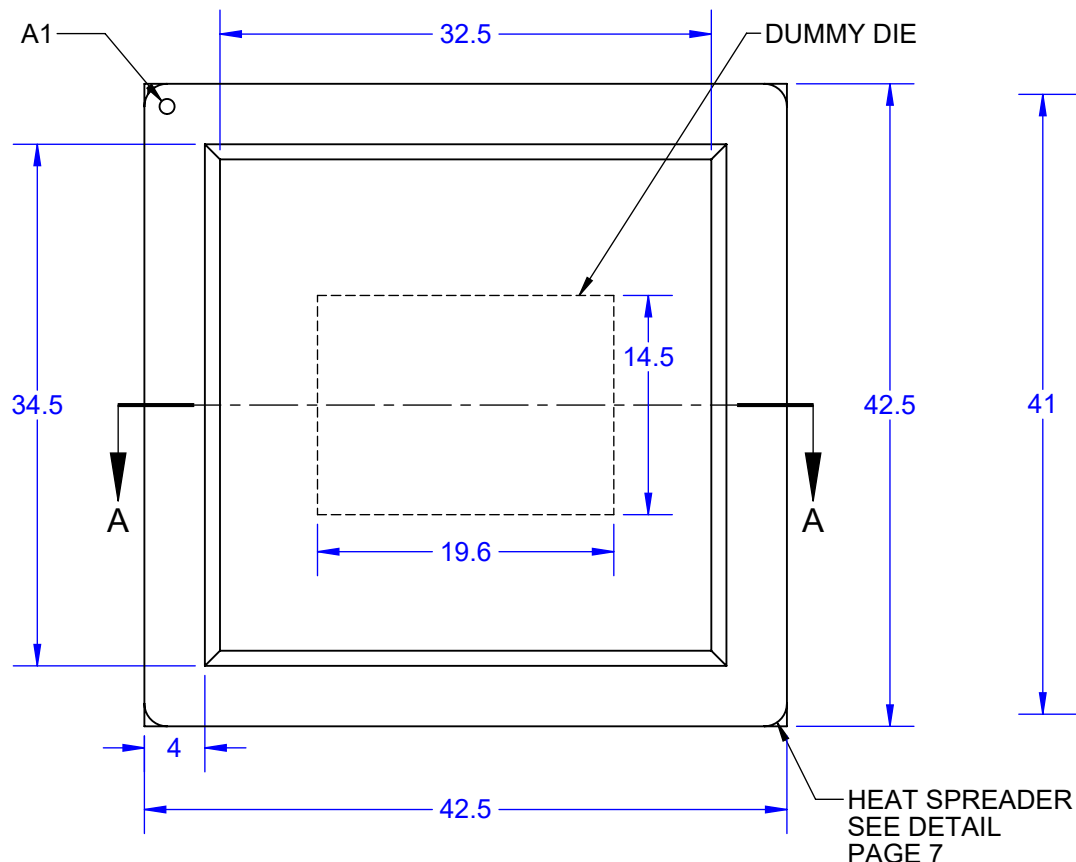

### PAD VIEW

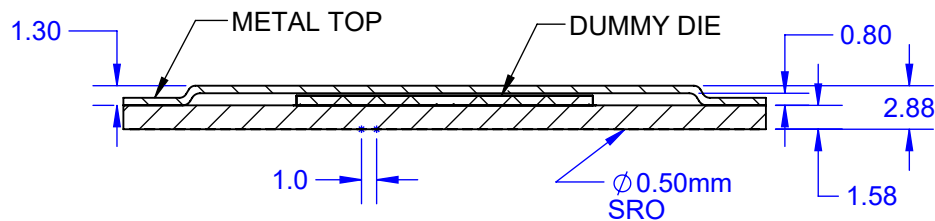
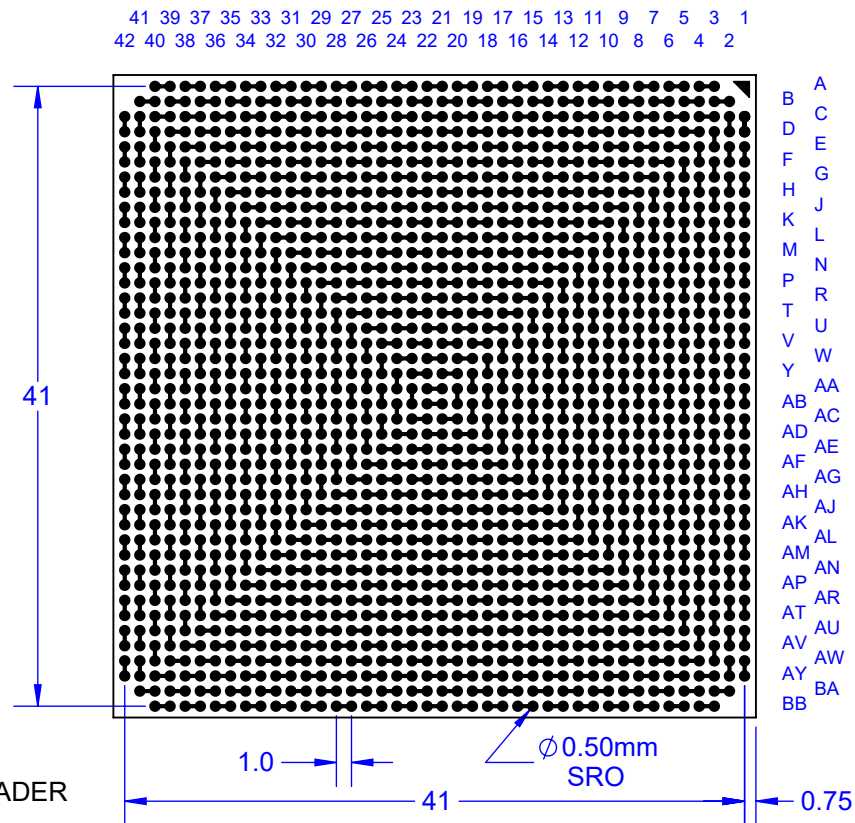

SECTION A-A

Notes: (Unless Otherwise Specified).

- 1) ALL DIMENSIONS ARE IN MM.
- 2) SOLDER BALL ALLOY: SEE PART NUMBER TABLE.
- 3) BALL DIAMETER (BEFORE REFLOW) 0.635mm [25mil].
- 4) SOLDER MASK DEFINED PAD OPENING: 0.508mm [20mil].
- 5) PAD Cu DIAMETER: 0.635 [0.25 mil].
- 6) SUBSTRATE MATERIAL: FR4.
- 7) DUMMY DIE: Si (SILICON).
- 8) DAISY CHAIN PATTERN (SEE PAGE 2).
- 9) MSL-3 RECOMMENDED BAKING 24 HOURS @ 125°C TO REMOVE MOISTURE PRIOR TO SOLDERING TO PC BOARD.

#### PART NUMBER TABLE

PART NUMBER	PAD & PLATING	BALL	RoHS	Si DIE
LGA1752T1.0G20-DC427D	Cu 35um (0.7mil) Ni - 3.8um (150 micro-inch) Au - 0.127um (5 micro-inch)	NONE	YES	YES

APPROVALS	DATE	<b>TopLine®</b>			
DRAWN T.Au	09/12/16				
ENG M. Hart	09/12/16	TITLE LGA1752T1.0G20-DC427D DAISY CHAIN DUMMY			
MFG		SCALE	SIZE	DRAWING NO.	REV
QA		2:1	A	514278	A
CUST		DO NOT SCALE DRAWING			SHEET 1 OF 14
REVISED					

# PAD VIEW

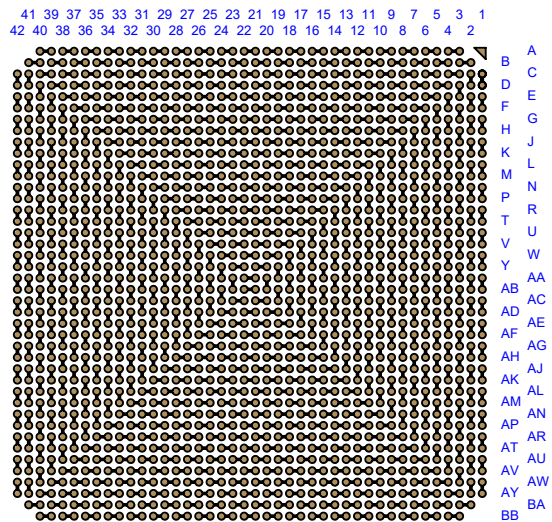

# BOTTOM SIDE (TOP X-RAY VIEW)

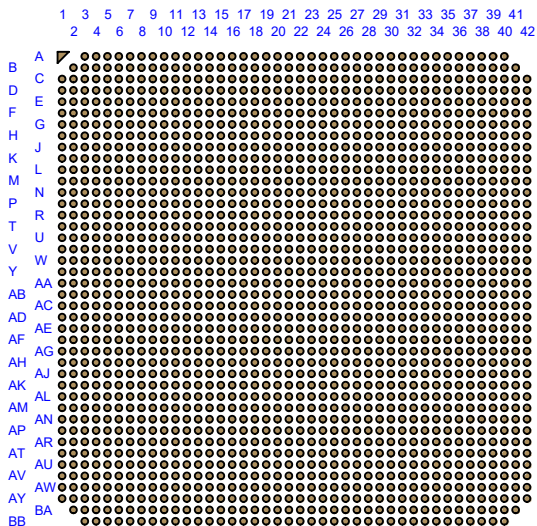
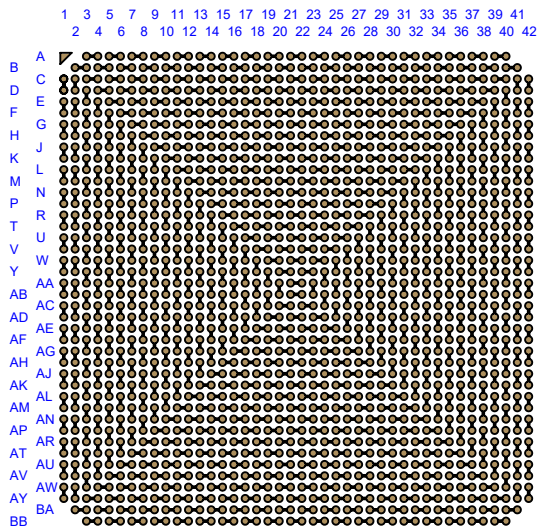

**TEST VEHICLE BOARD**  
UNDER DEVELOPMENT

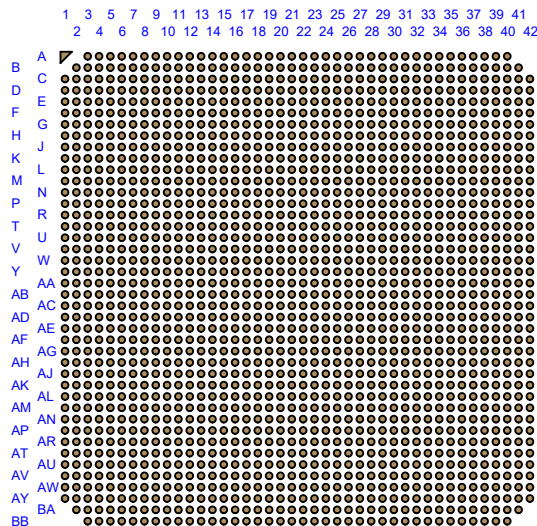

**TEST VEHICLE BOARD**  
UNDER DEVELOPMENT

Notes: (Unless Otherwise Specified).

- 1) PCB BOARD DIMENSIONS ARE PRESENTED ONLY AS A GUIDELINE DESIGNERS SHOULD USE THEIR OWN KNOWLEDGE WHEN DESIGNING THE PCB.
- 2) PCB Cu BALL PAD DIAMETER: 0.635 [25mil].
- 3) PCB DAISY CHAIN TRACING LINE WIDTH: 0.152 [6mil].
- 4) SMD (SOLDERMASK DEFINED) PAD OPENING: 0.508mm [20mil].

<b>TopLine®</b>			
TITLE		LGA1752T1.0G20-DC427D DAISY CHAIN DUMMY	
SCALE	SIZE	DRAWING NO.	REV
3:2	A	514278	A
DO NOT SCALE DRAWING			SHEET 2 OF 14

# PAD VIEW

42 41 40 39 38 37 36 35 34 33 32 31 30 29 28 27 26 25 24 23 22 21 20 19 18 17 16 15 14 13 12 11 10 9 8 7 6 5 4 3 2 1

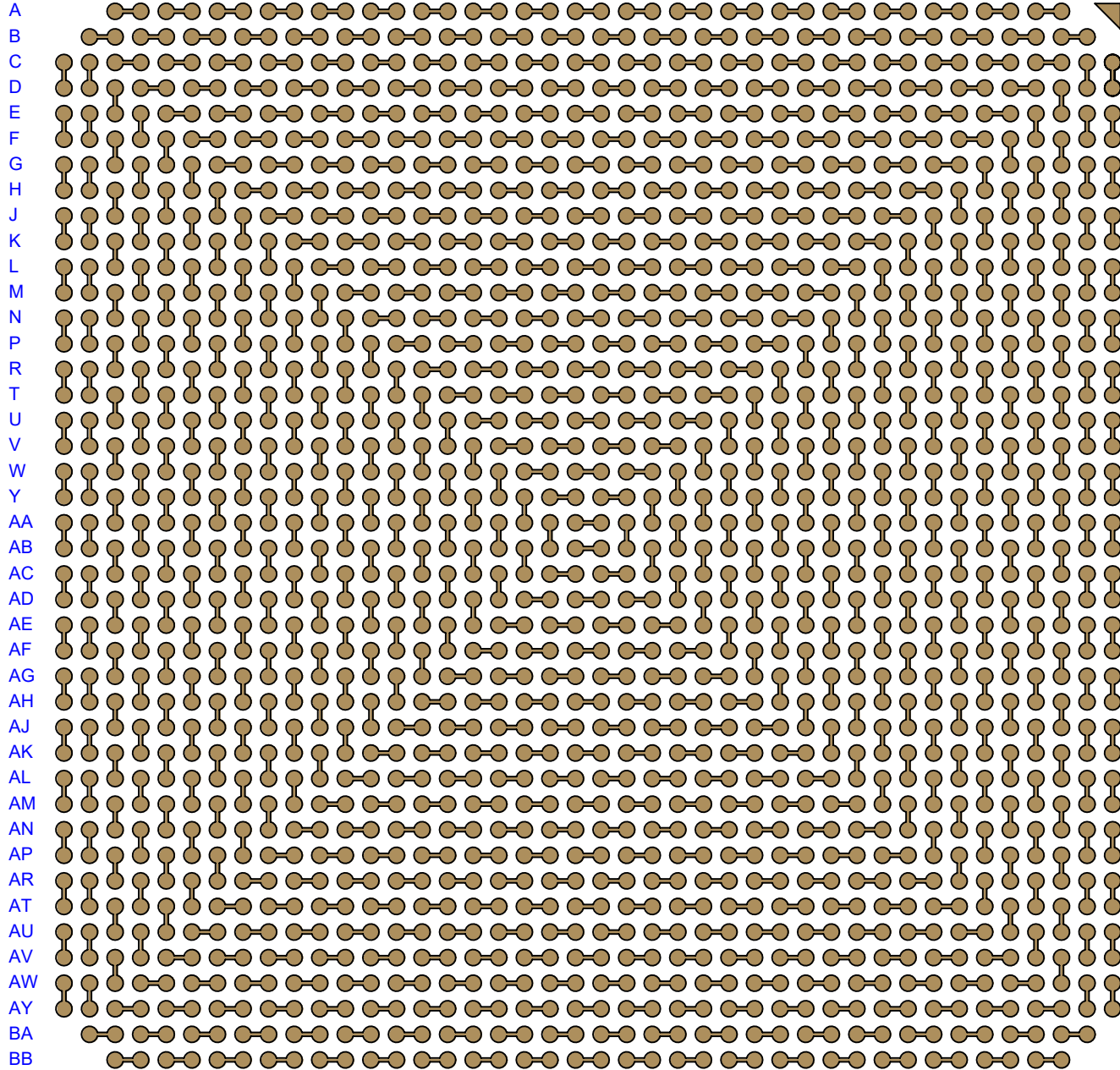

<b>TopLine®</b>			
TITLE LGA1752T1.0G20-DC427D DAISY CHAIN DUMMY			
SCALE 4:1	SIZE A	DRAWING NO. 514278	REV A
DO NOT SCALE DRAWING			SHEET 3 OF 14

# BOTTOM SIDE (TOP X-RAY VIEW)

1 2 3 4 5 6 7 8 9 10 11 12 13 14 15 16 17 18 19 20 21 22 23 24 25 26 27 28 29 30 31 32 33 34 35 36 37 38 39 40 41 42

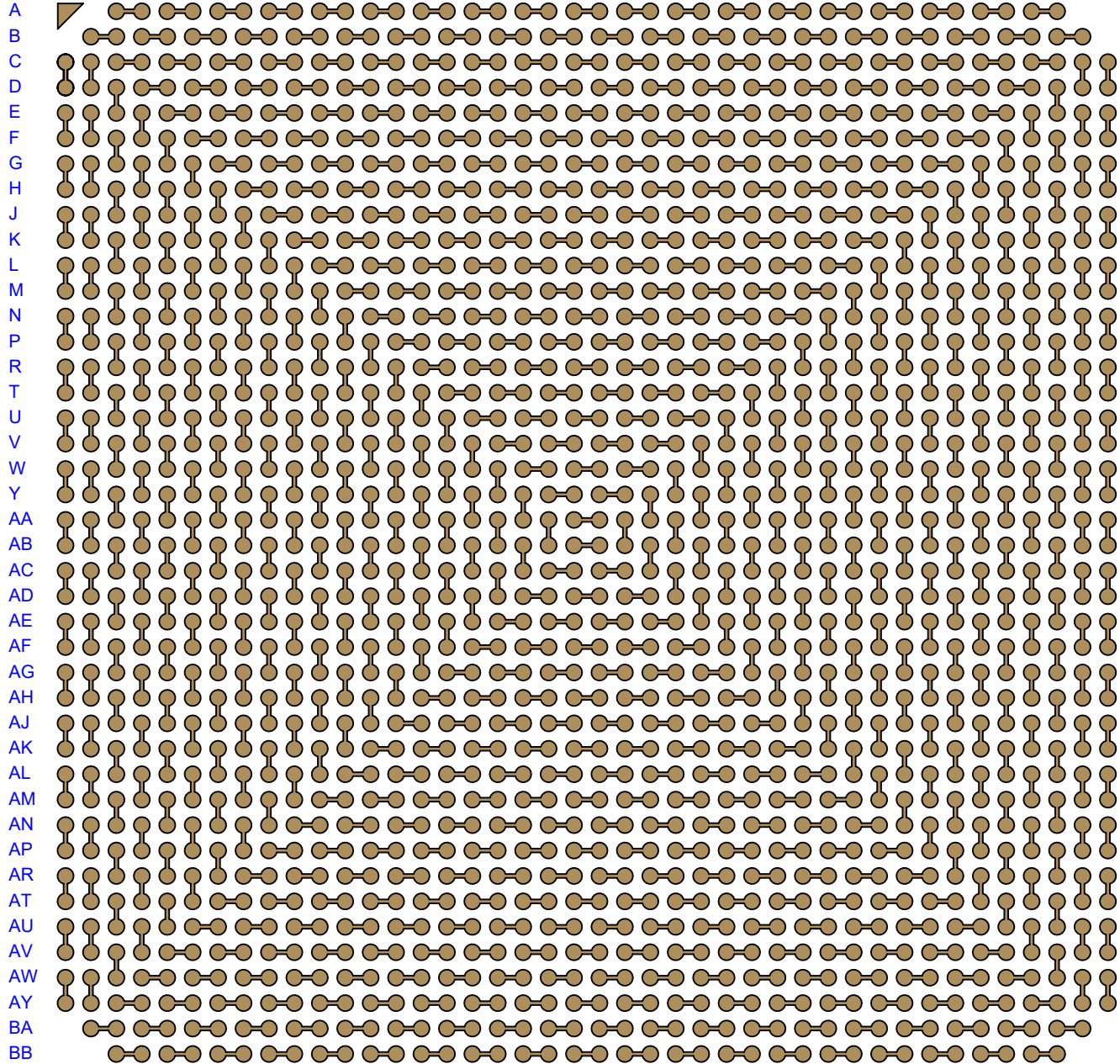

TITLE			
LGA1752T1.0G20-DC427D DAISY CHAIN DUMMY			
SCALE	SIZE	DRAWING NO.	REV
4:1	A	514278	A
DO NOT SCALE DRAWING			SHEET 4 OF 14

# HEAT SPREADER

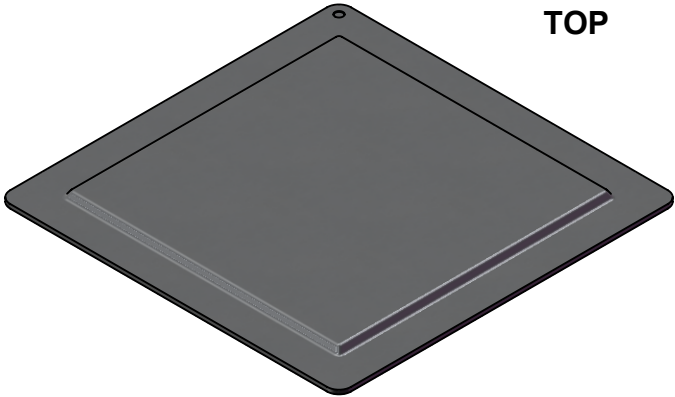
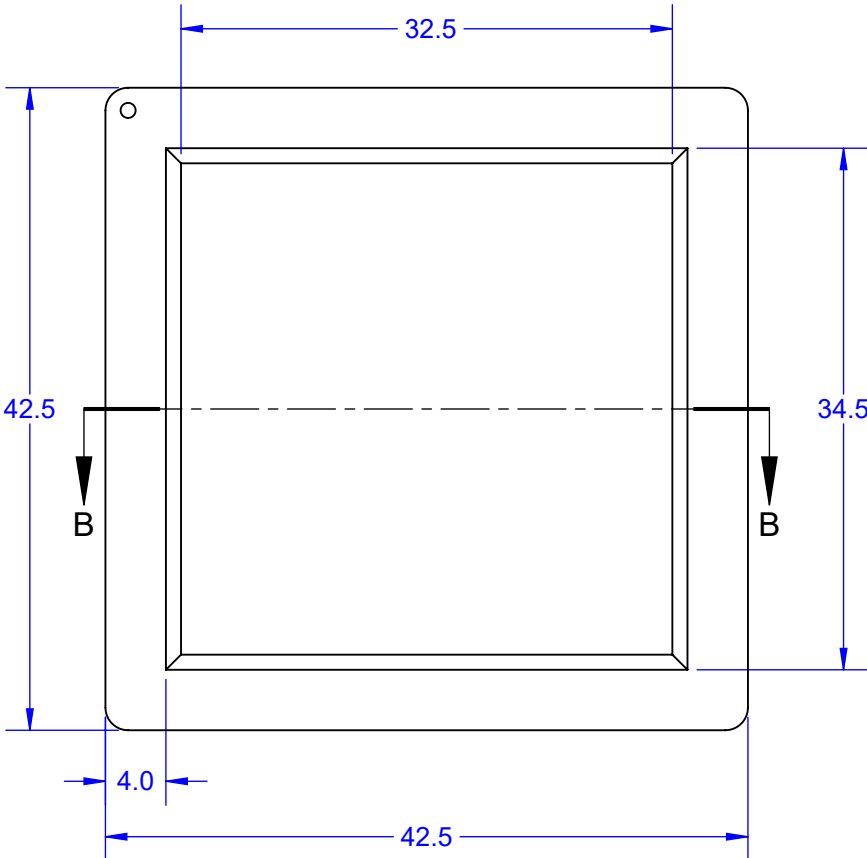

TOP

MODEL

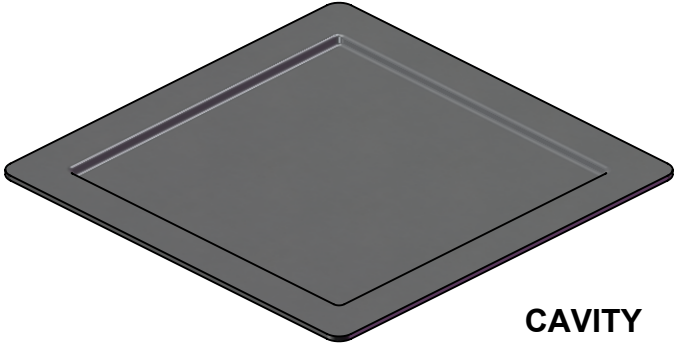

CAVITY

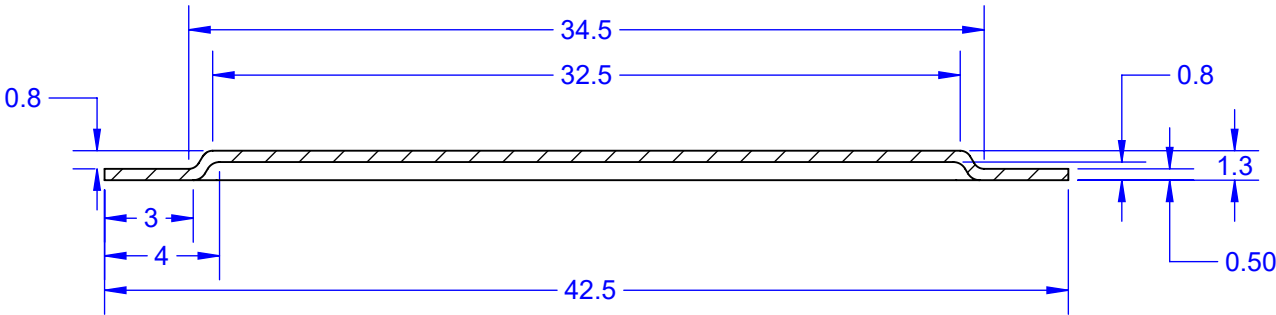

SECTION B-B  
SCALE 3 : 1

<b>TopLine<sup>®</sup></b>			
TITLE LGA1752T1.0G20-DC427D DAISY CHAIN DUMMY			
SCALE 2:1	SIZE A	DRAWING NO. 514278	REV A
DO NOT SCALE DRAWING			SHEET 5 OF 14

# MODEL

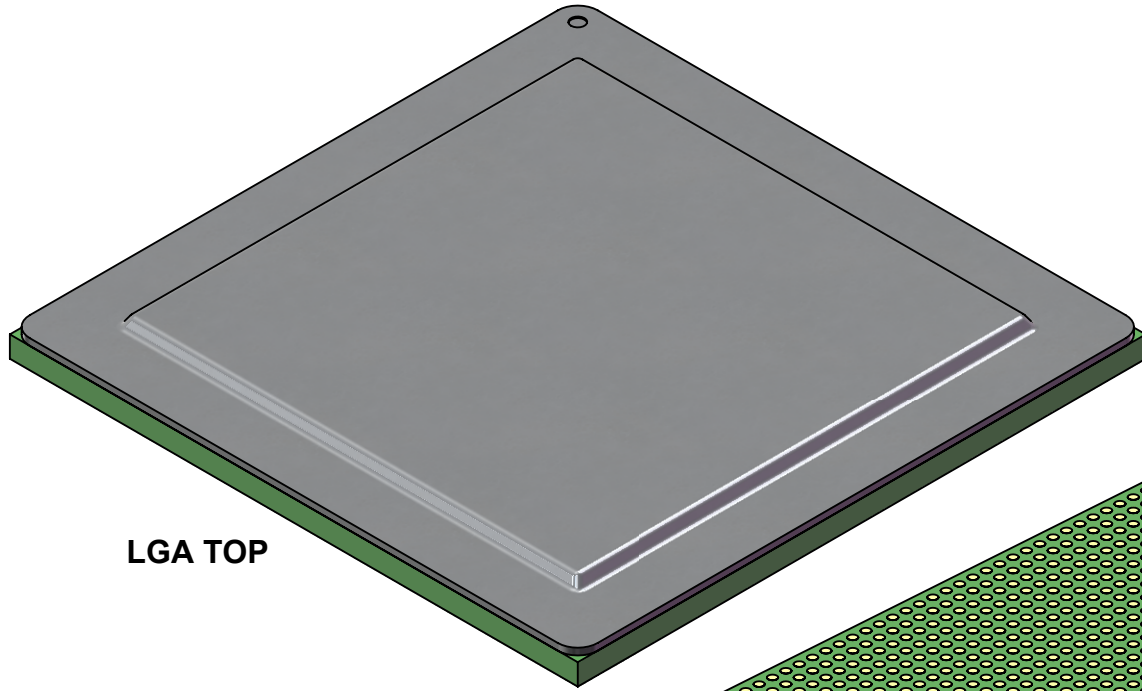

LGA TOP

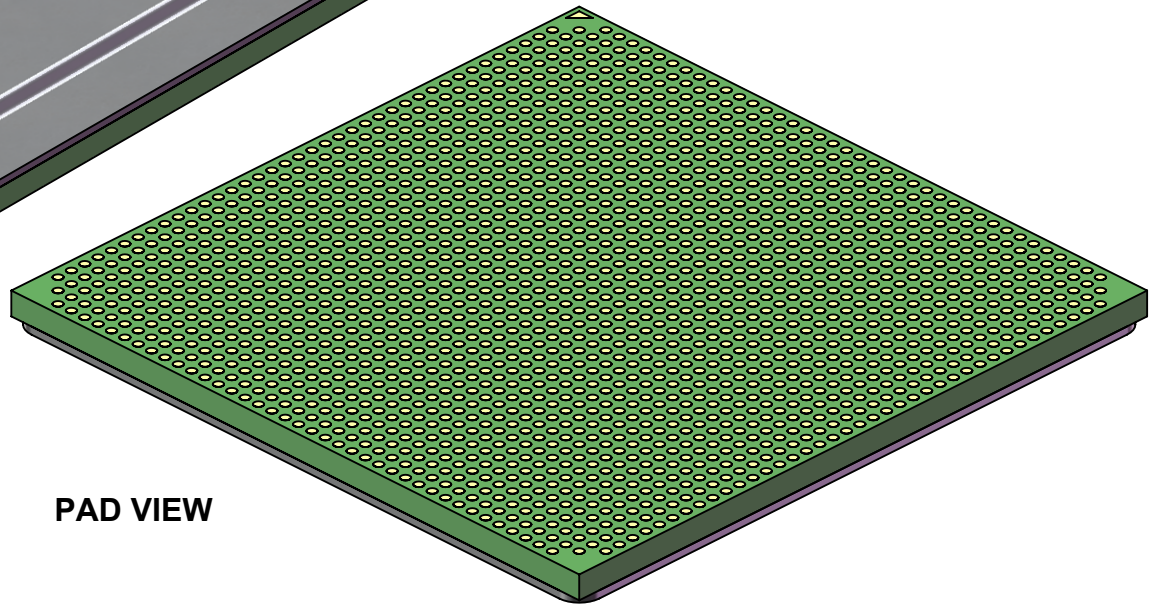

PAD VIEW

**TopLine<sup>®</sup>**

TITLE LGA1752T1.0G20-DC427D  
DAISY CHAIN DUMMY

SCALE 2.5:1	SIZE A	DRAWING NO. 514278	REV A
----------------	-----------	-----------------------	----------

DO NOT SCALE DRAWING

SHEET 6 OF 14

# NET LIST DAISY CHAIN CONNECTION TABLE

DC PAIR	
A3	A4
A5	A6
A7	A8
A9	A10
A11	A12
A13	A14
A15	A16
A17	A18
A19	A20
A21	A22
A23	A24
A25	A26
A27	A28
A29	A30
A31	A32
A33	A34
A35	A36
A37	A38
A39	A40
B2	B3
B4	B5
B6	B7
B8	B9
B10	B11
B12	B13
B14	B15
B16	B17
B18	B19
B20	B21
B22	B23
B24	B25
B26	B27
B28	B29
B30	B31
B32	B33
B34	B35
B36	B37
B38	B39
B40	B41

DC PAIR	
C1	D1
C2	D2
C3	C4
C5	C6
C7	C8
C9	C10
C11	C12
C13	C14
C15	C16
C17	C18
C19	C20
C21	C22
C23	C24
C25	C26
C27	C28
C29	C30
C31	C32
C33	C34
C35	C36
C37	C38
C39	C40
C41	D41
C42	D42
D3	E3
D4	D5
D6	D7
D8	D9
D10	D11
D12	D13
D14	D15
D16	D17
D18	D19
D20	D21
D22	D23
D24	D25
D26	D27
D28	D29
D30	D31
D32	D33
D34	D35
D36	D37
D38	D39
D40	E40

DC PAIR	
E1	F1
E2	F2
E4	F4
E5	E6
E7	E8
E9	E10
E11	E12
E13	E14
E15	E16
E17	E18
E19	E20
E21	E22
E23	E24
E25	E26
E27	E28
E29	E30
E31	E32
E33	E34
E35	E36
E37	E38
E39	F39
E41	F41
E42	F42
F3	G3
F5	G5
F6	F7
F8	F9
F10	F11
F12	F13
F14	F15
F16	F17
F18	F19
F20	F21
F22	F23
F24	F25
F26	F27
F28	F29
F30	F31
F32	F33
F34	F35
F36	F37
F38	G38
F40	G40

DC PAIR	
G1	H1
G2	H2
G4	H4
G6	H6
G7	G8
G9	G10
G11	G12
G13	G14
G15	G16
G17	G18
G19	G20
G21	G22
G23	G24
G25	G26
G27	G28
G29	G30
G31	G32
G33	G34
G35	G36
G37	H37
G39	H39
G41	H41
G42	H42
H3	J3
H5	J5
H7	J7
H8	H9
H10	H11
H12	H13
H14	H15
H16	H17
H18	H19
H20	H21
H22	H23
H24	H25
H26	H27
H28	H29
H30	H31
H32	H33
H34	H35
H36	J36
H38	J38
H40	J40

DC PAIR	
J1	K1
J2	K2
J4	K4
J6	K6
J8	K8
J9	J10
J11	J12
J13	J14
J15	J16
J17	J18
J19	J20
J21	J22
J23	J24
J25	J26
J27	J28
J29	J30
J31	J32
J33	J34
J35	K35
J37	K37
J39	K39
J41	K41
J42	K42
K3	L3
K5	L5
K7	L7
K9	L9
K10	K11
K12	K13
K14	K15
K16	K17
K18	K19
K20	K21
K22	K23
K24	K25
K26	K27
K28	K29
K30	K31
K32	K33
K34	L34
K36	L36
K38	L38
K40	L40

DC PAIR	
L1	M1
L2	M2
L4	M4
L6	M6
L8	M8
L10	M10
L11	L12
L13	L14
L15	L16
L17	L18
L19	L20
L21	L22
L23	L24
L25	L26
L27	L28
L29	L30
L31	L32
L33	M33
L35	M35
L37	M37
L39	M39
L41	M41
L42	M42
M3	N3
M5	N5
M7	N7
M9	N9
M11	N11
M12	M13
M14	M15
M16	M17
M18	M19
M20	M21
M22	M23
M24	M25
M26	M27
M28	M29
M30	M31
M32	N32
M34	N34
M36	N36
M38	N38
M40	N40

DC PAIR	
N1	P1
N2	P2
N4	P4
N6	P6
N8	P8
N10	P10
N12	P12
N13	N14
N15	N16
N17	N18
N19	N20
N21	N22
N23	N24
N25	N26
N27	N28
N29	N30
N31	P31
N33	P33
N35	P35
N37	P37
N39	P39
N41	P41
N42	P42
P3	R3
P5	R5
P7	R7
P9	R9
P11	R11
P13	R13
P14	P15
P16	P17
P18	P19
P20	P21
P22	P23
P24	P25
P26	P27
P28	P29
P30	R30
P32	R32
P34	R34
P36	R36
P38	R38
P40	R40

CONTINUED NEXT PAGE

			
TITLE LGA1752T1.0G20-DC427D DAISY CHAIN DUMMY			
SCALE NONE	SIZE A	DRAWING NO. 514278	REV A
DO NOT SCALE DRAWING			SHEET 7 OF 14

# NET LIST DAISY CHAIN CONNECTION TABLE

DC PAIR		DC PAIR		DC PAIR		DC PAIR		DC PAIR		DC PAIR		DC PAIR	
R1	T1	U1	V1	W1	Y1	AA1	AB1	AC1	AD1	AE1	AF1	AG1	AH1
R2	T2	U2	V2	W2	Y2	AA2	AB2	AC2	AD2	AE2	AF2	AG2	AH2
R4	T4	U4	V4	W4	Y4	AA4	AB4	AC4	AD4	AE4	AF4	AG4	AH4
R6	T6	U6	V6	W6	Y6	AA6	AB6	AC6	AD6	AE6	AF6	AG6	AH6
R8	T8	U8	V8	W8	Y8	AA8	AB8	AC8	AD8	AE8	AF8	AG8	AH8
R10	T10	U10	V10	W10	Y10	AA10	AB10	AC10	AD10	AE10	AF10	AG10	AH10
R12	T12	U12	V12	W12	Y12	AA12	AB12	AC12	AD12	AE12	AF12	AG12	AH12
R14	T14	U14	V14	W14	Y14	AA14	AB14	AC14	AD14	AE14	AF14	AG14	AH14
R15	R16	U16	V16	W16	Y16	AA16	AB16	AC16	AD16	AE16	AF16	AG16	AG17
R17	R18	U17	U18	W18	Y18	AA18	AB18	AC18	AD18	AE18	AE19	AG18	AG19
R19	R20	U19	U20	W19	W20	AA20	AB20	AC20	AC21	AE20	AE21	AG20	AG21
R21	R22	U21	U22	W21	W22	AA23	AB23	AC22	AC23	AE22	AE23	AG22	AG23
R23	R24	U23	U24	W23	W24	AA25	AB25	AC25	AD25	AE24	AE25	AG24	AG25
R25	R26	U25	U26	W25	Y25	AA27	AB27	AC27	AD27	AE27	AF27	AG26	AG27
R27	R28	U27	V27	W27	Y27	AA29	AB29	AC29	AD29	AE29	AF29	AG29	AH29
R29	T29	U29	V29	W29	Y29	AA31	AB31	AC31	AD31	AE31	AF31	AG31	AH31
R31	T31	U31	V31	W31	Y31	AA33	AB33	AC33	AD33	AE33	AF33	AG33	AH33
R33	T33	U33	V33	W33	Y33	AA35	AB35	AC35	AD35	AE35	AF35	AG35	AH35
R35	T35	U35	V35	W35	Y35	AA37	AB37	AC37	AD37	AE37	AF37	AG37	AH37
R37	T37	U37	V37	W37	Y37	AA39	AB39	AC39	AD39	AE39	AF39	AG39	AH39
R39	T39	U39	V39	W39	Y39	AA41	AB41	AC41	AD41	AE41	AF41	AG41	AH41
R41	T41	U41	V41	W41	Y41	AA42	AB42	AC42	AD42	AE42	AF42	AG42	AH42
R42	T42	U42	V42	W42	Y42	AB3	AC3	AD3	AE3	AF3	AG3	AH3	AJ3
T3	U3	V3	W3	AA3	Y3	AB5	AC5	AD5	AE5	AF5	AG5	AH5	AJ5
T5	U5	V5	W5	AA5	Y5	AB7	AC7	AD7	AE7	AF7	AG7	AH7	AJ7
T7	U7	V7	W7	AA7	Y7	AB9	AC9	AD9	AE9	AF9	AG9	AH9	AJ9
T9	U9	V9	W9	AA9	Y9	AB11	AC11	AD11	AE11	AF11	AG11	AH11	AJ11
T11	U11	V11	W11	AA11	Y11	AB13	AC13	AD13	AE13	AF13	AG13	AH13	AJ13
T13	U13	V13	W13	AA13	Y13	AB15	AC15	AD15	AE15	AF15	AG15	AH15	AH16
T15	U15	V15	W15	AA15	Y15	AB17	AC17	AD17	AE17	AF17	AF18	AH17	AH18
T16	T17	V17	W17	AA17	Y17	AB19	AC19	AD19	AD20	AF19	AF20	AH19	AH20
T18	T19	V18	V19	AA19	Y19	AB21	AB22	AD21	AD22	AF21	AF22	AH21	AH22
T20	T21	V20	V21	Y20	Y21	AA21	AA22	AD23	AD24	AF23	AF24	AH23	AH24
T22	T23	V22	V23	Y22	Y23	AB24	AC24	AD26	AE26	AF25	AF26	AH25	AH26
T24	T25	V24	V25	AA24	Y24	AB26	AC26	AD28	AE28	AF28	AG28	AH27	AH28
T26	T27	V26	W26	AA26	Y26	AB28	AC28	AD30	AE30	AF30	AG30	AH30	AJ30
T28	U28	V28	W28	AA28	Y28	AB30	AC30	AD32	AE32	AF32	AG32	AH32	AJ32
T30	U30	V30	W30	AA30	Y30	AB32	AC32	AD34	AE34	AF34	AG34	AH34	AJ34
T32	U32	V32	W32	AA32	Y32	AB34	AC34	AD36	AE36	AF36	AG36	AH36	AJ36
T34	U34	V34	W34	AA34	Y34	AB36	AC36	AD38	AE38	AF38	AG38	AH38	AJ38
T36	U36	V36	W36	AA36	Y36	AB38	AC38	AD40	AE40	AF40	AG40	AH40	AJ40
T38	U38	V38	W38	AA38	Y38	AB40	AC40						
T40	U40	V40	W40	AA40	Y40								

CONTINUED NEXT PAGE

			
TITLE    LGA1752T1.0G20-DC427D DAISY CHAIN DUMMY			
SCALE NONE	SIZE A	DRAWING NO. 514278	REV A
DO NOT SCALE DRAWING			SHEET 8 OF 14



# NET LIST DAISY CHAIN CONNECTION TABLE

DC PAIR		DC PAIR		DC PAIR		DC PAIR		DC PAIR		DC PAIR		DC PAIR	
AJ1	AK1	AL1	AM1	AN1	AP1	AR1	AT1	AU1	AV1	AW1	AY1	BA2	BA3
AJ2	AK2	AL2	AM2	AN2	AP2	AR2	AT2	AU2	AV2	AW2	AY2	BA4	BA5
AJ4	AK4	AL4	AM4	AN4	AP4	AR4	AT4	AU4	AV4	AW4	AW5	BA6	BA7
AJ6	AK6	AL6	AM6	AN6	AP6	AR6	AT6	AU6	AU7	AW6	AW7	BA8	BA9
AJ8	AK8	AL8	AM8	AN8	AP8	AR8	AR9	AU8	AU9	AW8	AW9	BA10	BA11
AJ10	AK10	AL10	AM10	AN10	AN11	AR10	AR11	AU10	AU11	AW10	AW11	BA12	BA13
AJ12	AK12	AL12	AL13	AN12	AN13	AR12	AR13	AU12	AU13	AW12	AW13	BA14	BA15
AJ14	AJ15	AL14	AL15	AN14	AN15	AR14	AR15	AU14	AU15	AW14	AW15	BA16	BA17
AJ16	AJ17	AL16	AL17	AN16	AN17	AR16	AR17	AU16	AU17	AW16	AW17	BA18	BA19
AJ18	AJ19	AL18	AL19	AN18	AN19	AR18	AR19	AU18	AU19	AW18	AW19	BA20	BA21
AJ20	AJ21	AL20	AL21	AN20	AN21	AR20	AR21	AU20	AU21	AW20	AW21	BA22	BA23
AJ22	AJ23	AL22	AL23	AN22	AN23	AR22	AR23	AU22	AU23	AW22	AW23	BA24	BA25
AJ24	AJ25	AL24	AL25	AN24	AN25	AR24	AR25	AU24	AU25	AW24	AW25	BA26	BA27
AJ26	AJ27	AL26	AL27	AN26	AN27	AR26	AR27	AU26	AU27	AW26	AW27	BA28	BA29
AJ28	AJ29	AL28	AL29	AN28	AN29	AR28	AR29	AU28	AU29	AW28	AW29	BA30	BA31
AJ31	AK31	AL30	AL31	AN30	AN31	AR30	AR31	AU30	AU31	AW30	AW31	BA32	BA33
AJ33	AK33	AL33	AM33	AN32	AN33	AR32	AR33	AU32	AU33	AW32	AW33	BA34	BA35
AJ35	AK35	AL35	AM35	AN35	AP35	AR34	AR35	AU34	AU35	AW34	AW35	BA36	BA37
AJ37	AK37	AL37	AM37	AN37	AP37	AR37	AT37	AU36	AU37	AW36	AW37	BA38	BA39
AJ39	AK39	AL39	AM39	AN39	AP39	AR39	AT39	AU39	AV39	AW38	AW39	BA40	BA41
AJ41	AK41	AL41	AM41	AN41	AP41	AR41	AT41	AU41	AV41	AW41	AY41	BB3	BB4
AJ42	AK42	AL42	AM42	AN42	AP42	AR42	AT42	AU42	AV42	AW42	AY42	BB5	BB6
AK3	AL3	AM3	AN3	AP3	AR3	AT3	AU3	AV3	AW3	AY3	AY4	BB7	BB8
AK5	AL5	AM5	AN5	AP5	AR5	AT5	AU5	AV5	AV6	AY5	AY6	BB9	BB10
AK7	AL7	AM7	AN7	AP7	AR7	AT7	AT8	AV7	AV8	AY7	AY8	BB11	BB12
AK9	AL9	AM9	AN9	AP9	AP10	AT9	AT10	AV9	AV10	AY9	AY10	BB13	BB14
AK11	AL11	AM11	AM12	AP11	AP12	AT11	AT12	AV11	AV12	AY11	AY12	BB15	BB16
AK13	AK14	AM13	AM14	AP13	AP14	AT13	AT14	AV13	AV14	AY13	AY14	BB17	BB18
AK15	AK16	AM15	AM16	AP15	AP16	AT15	AT16	AV15	AV16	AY15	AY16	BB19	BB20
AK17	AK18	AM17	AM18	AP17	AP18	AT17	AT18	AV17	AV18	AY17	AY18	BB21	BB22
AK19	AK20	AM19	AM20	AP19	AP20	AT19	AT20	AV19	AV20	AY19	AY20	BB23	BB24
AK21	AK22	AM21	AM22	AP21	AP22	AT21	AT22	AV21	AV22	AY21	AY22	BB25	BB26
AK23	AK24	AM23	AM24	AP23	AP24	AT23	AT24	AV23	AV24	AY23	AY24	BB27	BB28
AK25	AK26	AM25	AM26	AP25	AP26	AT25	AT26	AV25	AV26	AY25	AY26	BB29	BB30
AK27	AK28	AM27	AM28	AP27	AP28	AT27	AT28	AV27	AV28	AY27	AY28	BB31	BB32
AK29	AK30	AM29	AM30	AP29	AP30	AT29	AT30	AV29	AV30	AY29	AY30	BB33	BB34
AK32	AL32	AM31	AM32	AP31	AP32	AT31	AT32	AV31	AV32	AY31	AY32	BB35	BB36
AK34	AL34	AM34	AN34	AP33	AP34	AT33	AT34	AV33	AV34	AY33	AY34	BB37	BB38
AK36	AL36	AM36	AN36	AP36	AR36	AT35	AT36	AV35	AV36	AY35	AY36	BB39	BB40
AK38	AL38	AM38	AN38	AP38	AR38	AT38	AU38	AV37	AV38	AY37	AY38		
AK40	AL40	AM40	AN40	AP40	AR40	AT40	AU40	AV40	AW40	AY39	AY40		

			
TITLE    LGA1752T1.0G20-DC427D DAISY CHAIN DUMMY			
SCALE NONE	SIZE A	DRAWING NO. 514278	REV A
DO NOT SCALE DRAWING			SHEET 9 OF 14

# TOP LAYER - LAYER 1

1 2 3 4 5 6 7 8 9 10 11 12 13 14 15 16 17 18 19 20 21 22 23 24 25 26 27 28 29 30 31 32 33 34 35 36 37 38 39 40 41 42

A  
B  
C  
D  
E  
F  
G  
H  
J  
K  
L  
M  
N  
P  
R  
T  
U  
V  
W  
Y  
AA  
AB  
AC  
AD  
AE  
AF  
AG  
AH  
AJ  
AK  
AL  
AM  
AN  
AP  
AR  
AT  
AU  
AV  
AW  
AY  
BA  
BB

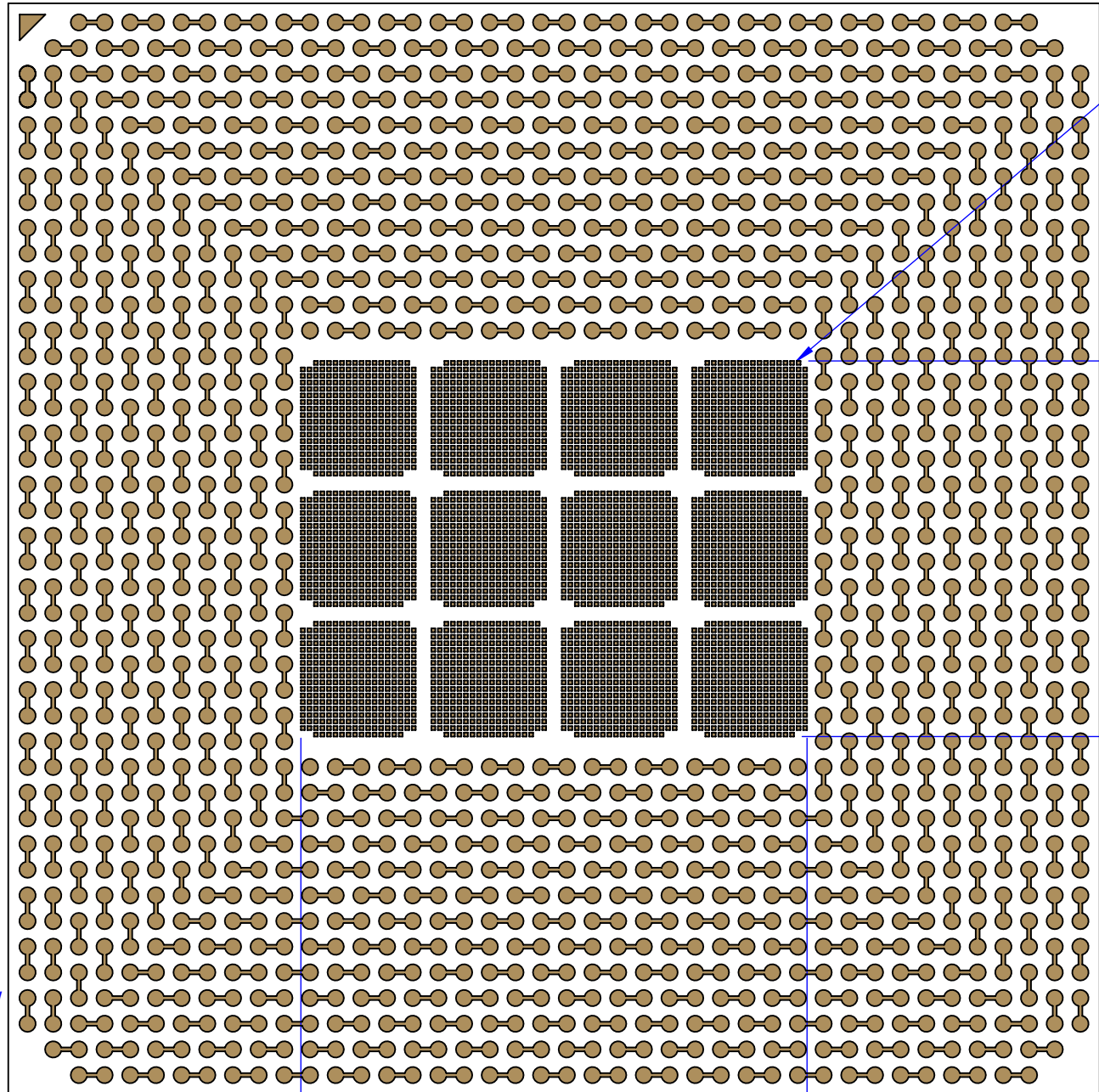

SEE DETAIL B  
PAGE 14

15.42

19.56

42.5

**TopLine**<sup>®</sup>

TITLE LGA1752T1.0G20-DC427D  
DAISY CHAIN DUMMY

SCALE 4:1	SIZE A	DRAWING NO. 514278	REV A
--------------	-----------	-----------------------	----------

DO NOT SCALE DRAWING

SHEET 10 OF 14

# GROUND PLANE - LAYER 2 and 3

1 2 3 4 5 6 7 8 9 10 11 12 13 14 15 16 17 18 19 20 21 22 23 24 25 26 27 28 29 30 31 32 33 34 35 36 37 38 39 40 41 42

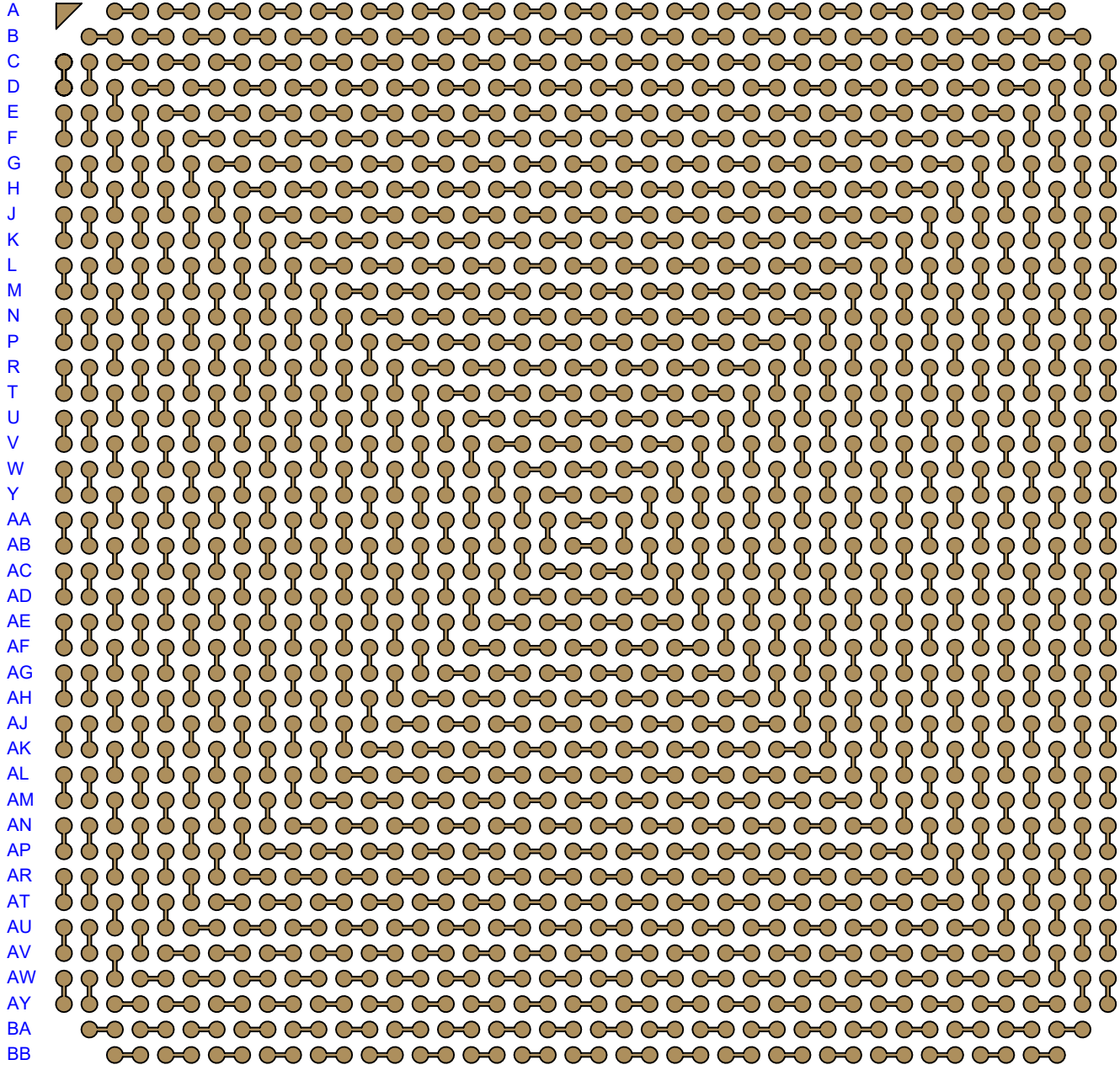

TITLE			
LGA1752T1.0G20-DC427D DAISY CHAIN DUMMY			
SCALE	SIZE	DRAWING NO.	REV
4:1	A	514278	A
DO NOT SCALE DRAWING			SHEET 11 OF 14

# BOTTOM SIDE (TOP X-RAY VIEW) - LAYER 4

1 2 3 4 5 6 7 8 9 10 11 12 13 14 15 16 17 18 19 20 21 22 23 24 25 26 27 28 29 30 31 32 33 34 35 36 37 38 39 40 41 42

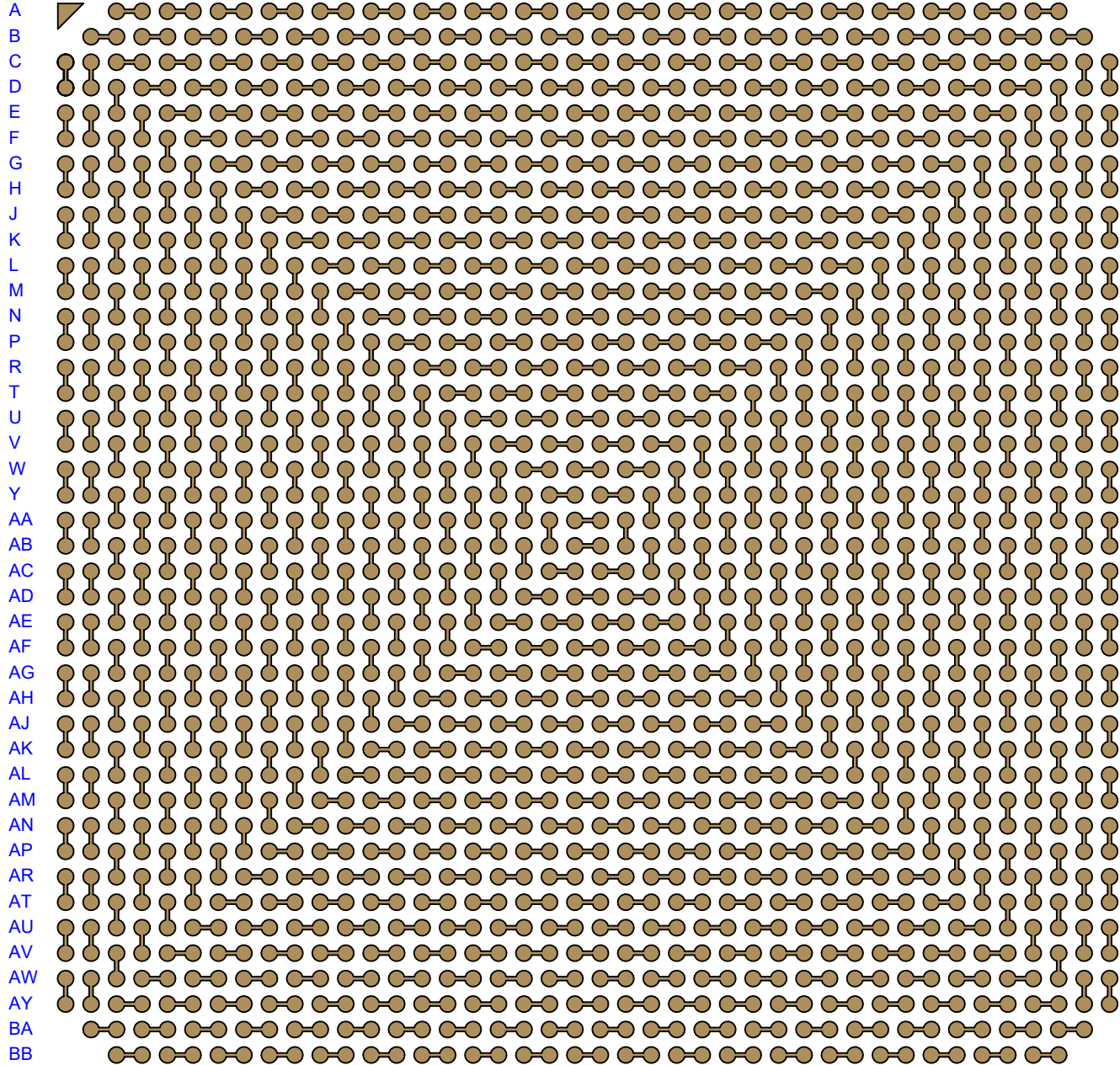

TITLE			
LGA1752T1.0G20-DC427D DAISY CHAIN DUMMY			
SCALE	SIZE	DRAWING NO.	REV
4:1	A	514278	A
DO NOT SCALE DRAWING			SHEET 12 OF 14

# BOTTOM SOLDER MASK (RIGHT READING)

42 41 40 39 38 37 36 35 34 33 32 31 30 29 28 27 26 25 24 23 22 21 20 19 18 17 16 15 14 13 12 11 10 9 8 7 6 5 4 3 2 1

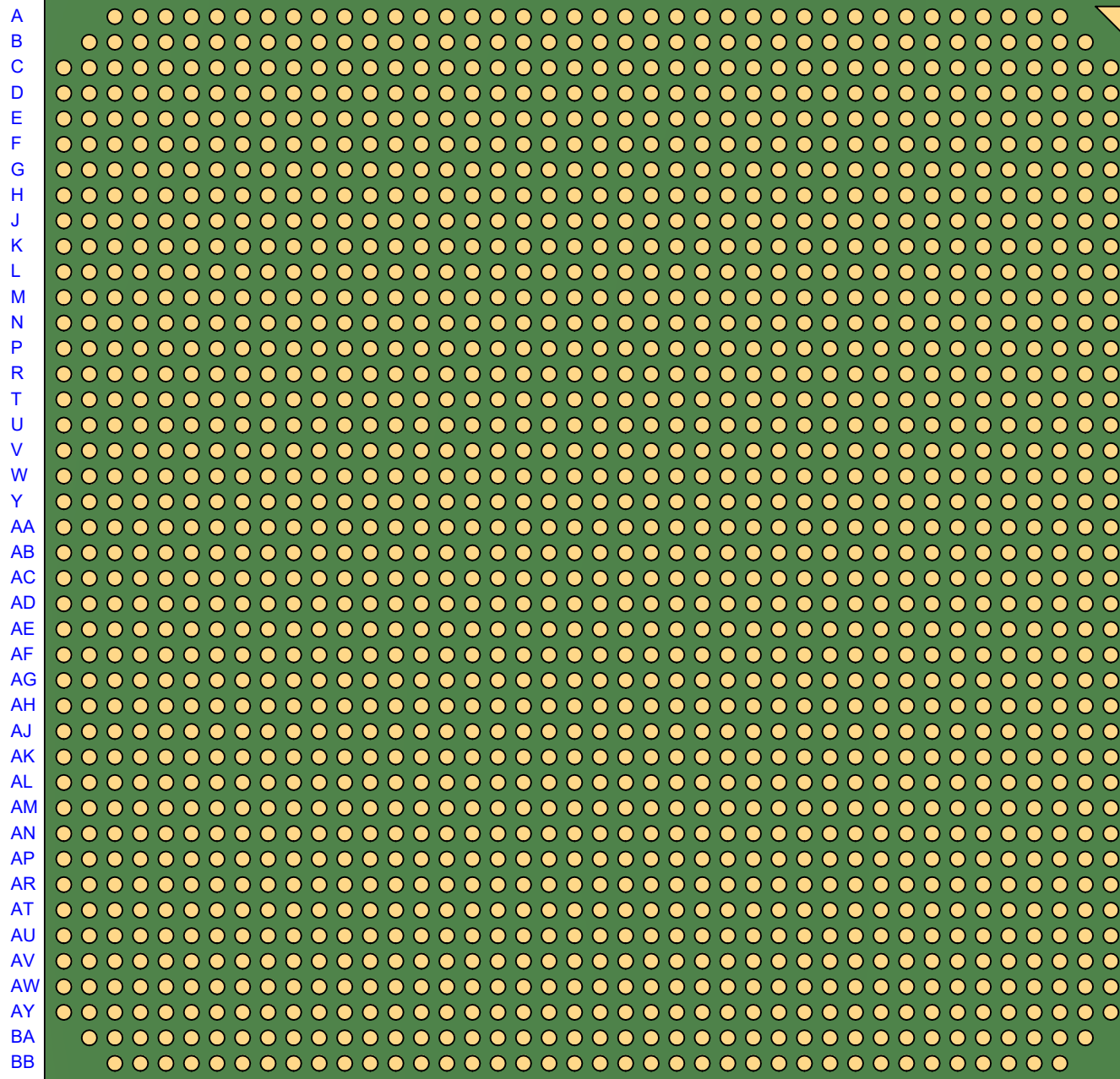

<b>TopLine<sup>®</sup></b>			
TITLE    LGA1752T1.0G20-DC427D DAISY CHAIN DUMMY			
SCALE 4:1	SIZE A	DRAWING NO. 514278	REV A
DO NOT SCALE DRAWING			SHEET 13 OF 14

# DETAIL B PCB DIE PADS (TOP) Micron (µm)

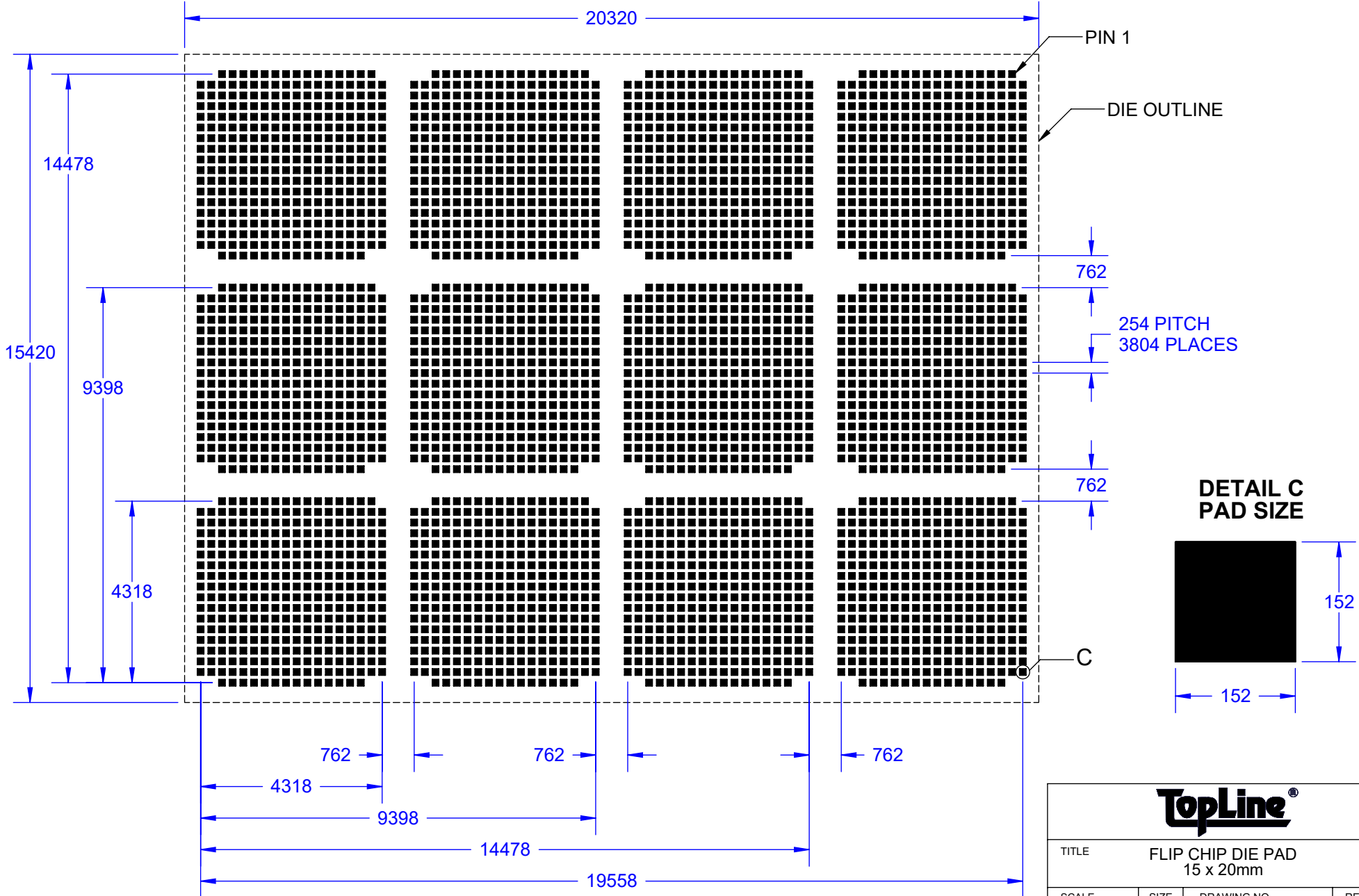

<b>TopLine®</b>			
TITLE		FLIP CHIP DIE PAD 15 x 20mm	
SCALE	SIZE	DRAWING NO.	REV
8:1	A	514278	A
DO NOT SCALE DRAWING			SHEET 14 OF 14