

Tel 1-714-898-3830
info@topline.tv

BALLS	PITCH	SIZE	MATRIX	ROWS	CENTER	MAT'L
1936	1.0mm	45mm SQ	44 x 44	full	full	FR4

BALL VIEW

BOTTOM SIDE (TOP X-RAY VIEW)

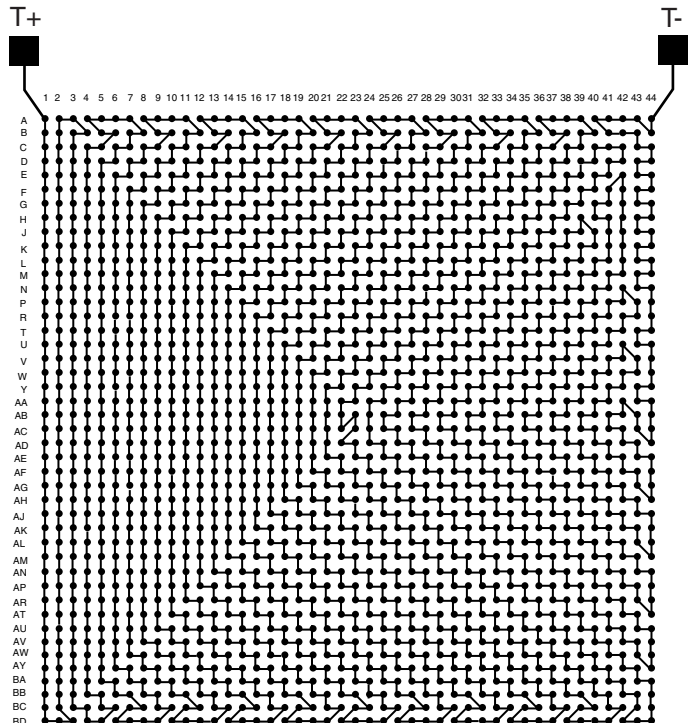
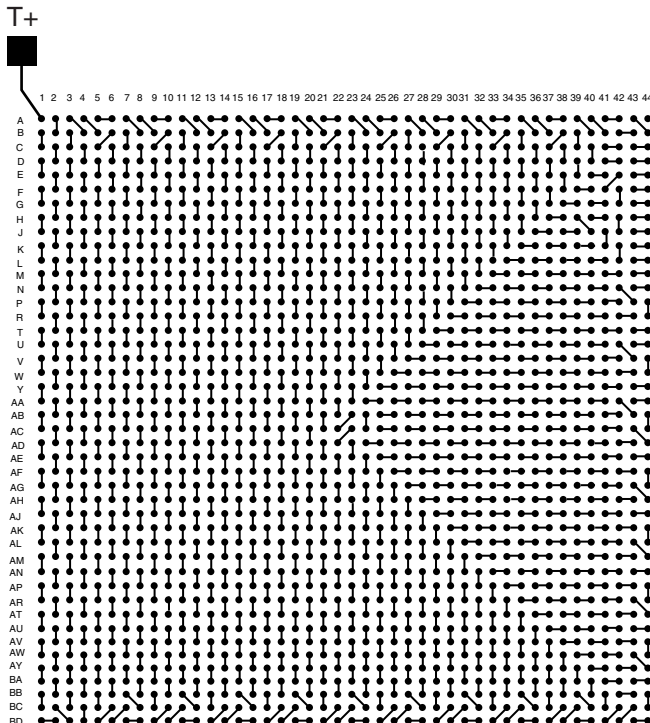
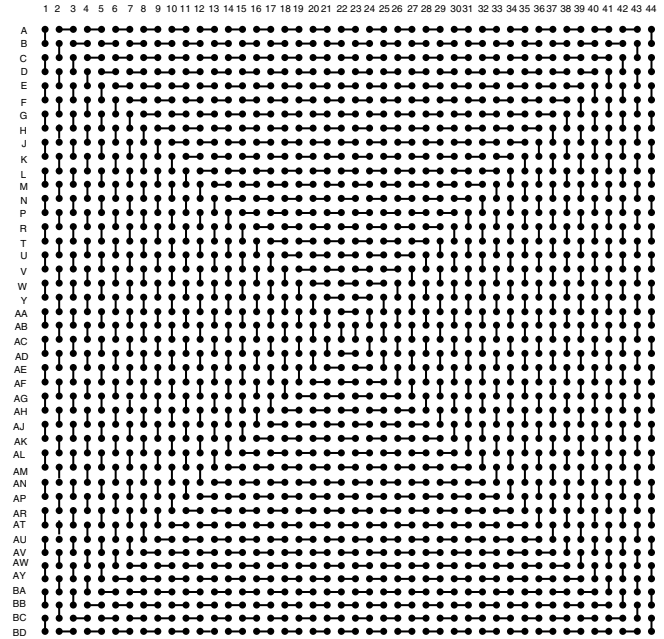
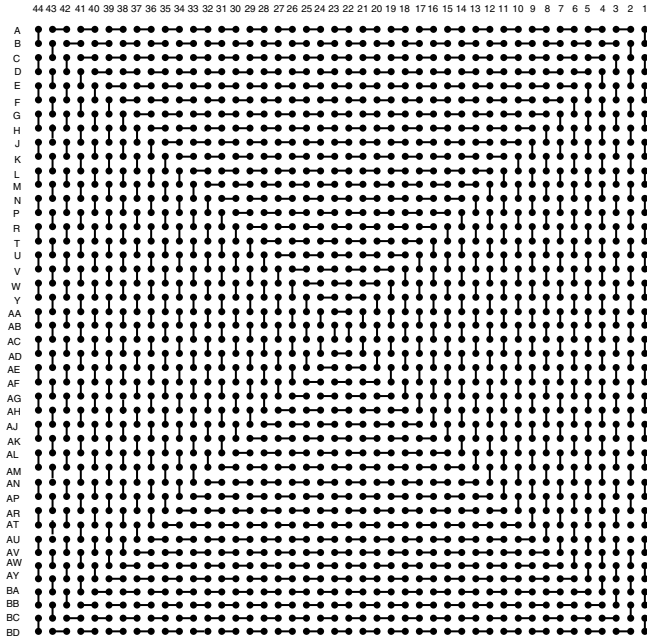

TEST VEHICLE BOARD

AFTER MOUNTING TO TEST BOARD

eBGA1936T1.0-D449D Lead Free



Tel 1-714-898-3830
info@topline.tv

<u>BALLS</u>	<u>PITCH</u>	<u>SIZE</u>	<u>MATRIX</u>	<u>ROWS</u>	<u>CENTER</u>	<u>MAT'L</u>
1936	1.0mm	45mm SQ	44 x 44	full	full	FR4

TOP VIEW

SIDE VIEW

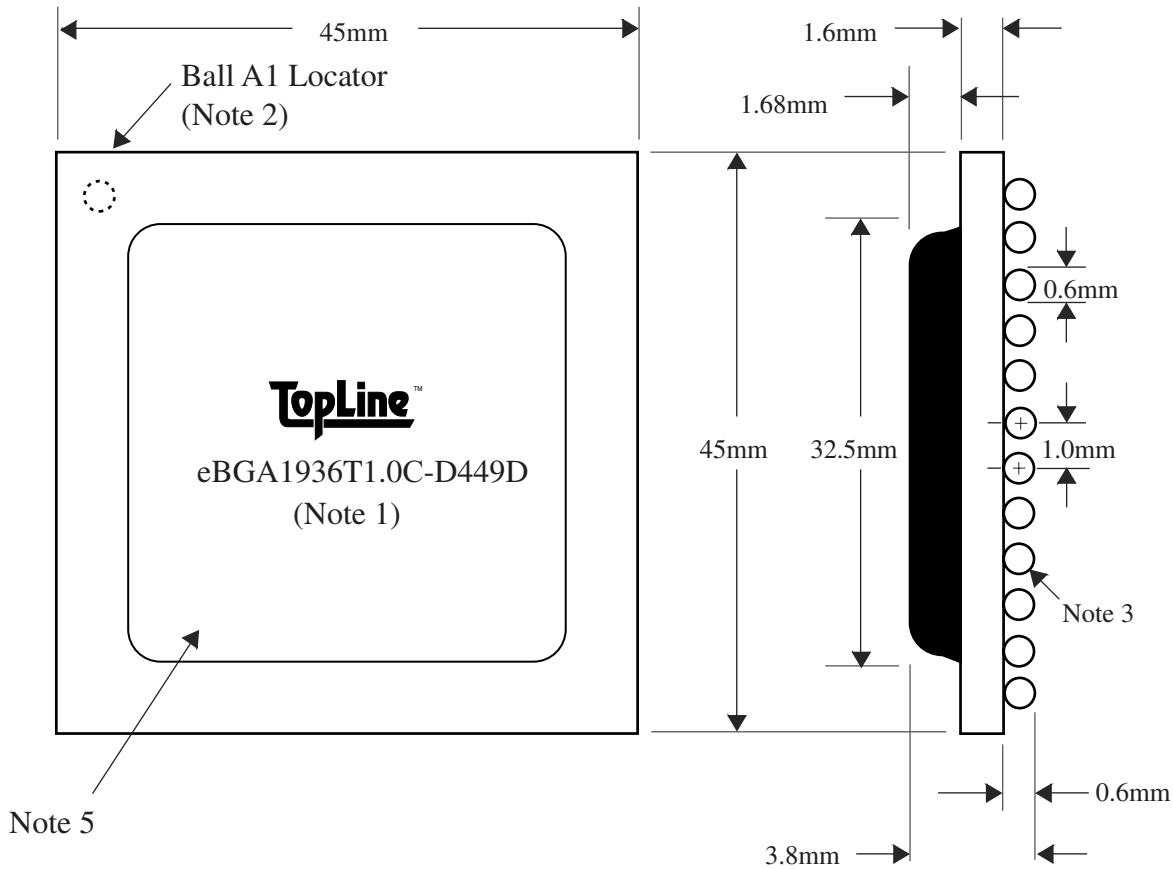

NOTES		REVISIONS		
Note 1	Logo and part number centered White ink	<u>Rev</u>	<u>Date</u>	<u>Changes</u>
Note 2	Ball A1 locator mark positioned in corner			
Note 3	Ball Material: Sn96.5 Ag3.0 Cu0.5			
Note 4	Substrate Material: FR4			
Note 5	Dummy Die 19mm x 19mm (750mil x 750mil)			
		packaging trays		
		Tray BGATRAY45mm-2x6 Tray Quantity 12		

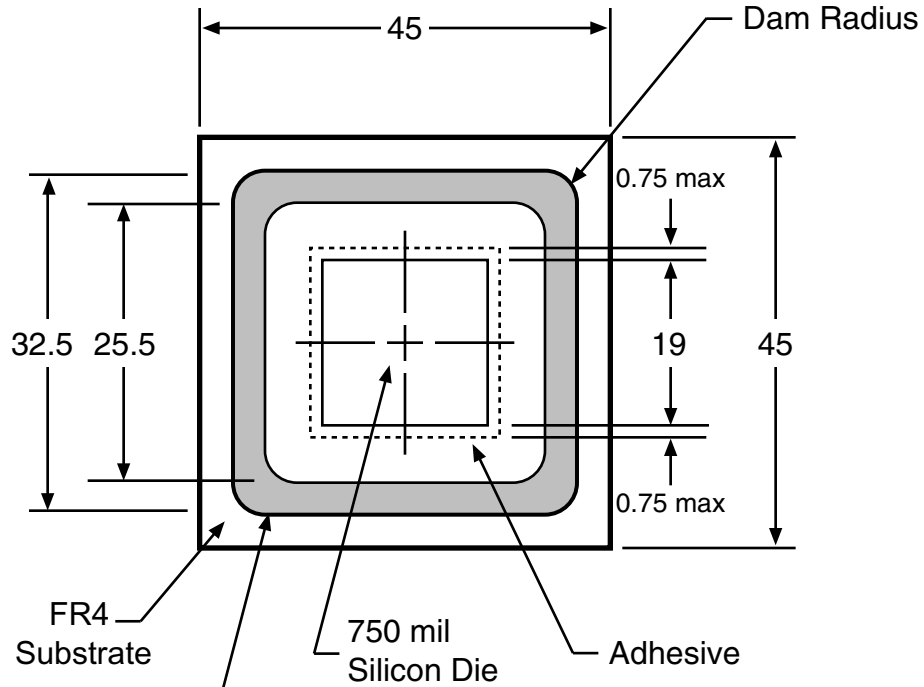

Top View
Shown Open Cavity

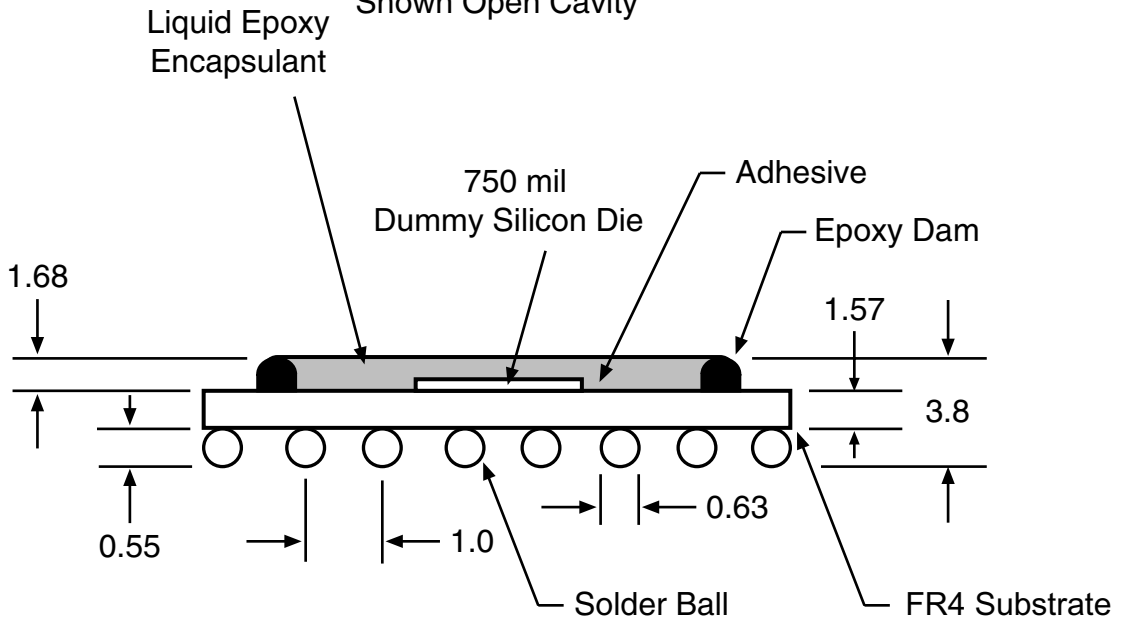

Side View

Drawing Not to Scale
Dimensions = mm