

DIP & ROTARY SWITCH

INDEX



Type

[click on page numbers](#)

Page

Changeover Slide Switch "DSS" Series	2.54mm Pin to Pin THT & SMT	2
Rotary Switch "DRD" Series	3:3 & 1:4 Pin-out SMT 2.54mm Pin to Pin	3
	3:3 Pin-out straight THT 2.54 x 7.62mm footprint	4
	1:4 Pin-out straight THT 2.54 x 7.62mm footprint	5
	3:3 Pin-out right angle THT 2.54 x 2.54mm footprint	6
	1:4 Pin-out right angle THT 2.54 x 2.54mm footprint	7
	3:3 Pin-out right angle THT 2.54 x 5.08mm footprint	8
	1:4 Pin-out right angle THT 2.54 x 5.08mm footprint	9
Slide Switch "DDG" & "DDS" Series	Standard Profile 2.54mm DIP Type THT	10 & 11
Slide Switch "DAH" Series	Auto Inserting 2.54mm DIP Type THT	12
Slide Switch "DAM" Series	End Stackable 2.54mm DIP Type THT	13
Slide Switch "DSD" & "DSL" Series	End Stackable 2.54mm DIP Type SMT	14
Slide Switch "DHS" Series	HALF PITCH (1.27mm) SMT	15
Slide TRI-STATE Switch "DTD" / "DTA" & "DTS" Series	Standard Profile 2.54mm DIP Type THT & SMT	16
Selector Slide Switch "DSP" Series	Standard 2.54mm DIP Type THT & SMT	17
Piano Switch "DPG" & "DPS" Series	Standard Profile 2.54mm DIP Type THT	18 & 19
Piano Switch "DPH" Series	Low Profile 2.54mm DIP Type THT	20
Piano Switch "DPI" Series	Low Profile, End Stackable 2.54mm DIP Type THT	21
Piano Switch "DPA" Series	Low Profile 2.54mm DIP Type SMT	22
Piano Switch "DPM" Series	Low Profile, End Stackable 2.54mm DIP Type SMT	23

Part-Number	Page	Part-Number	Page	Part-Number	Page	Part-Number	Page
DAH-1xx-E01Z	12	DDS-5xx-SRAZ	11	DPM-1xx-EB11Z	23	DRD-4xx-CRZ	7
DAH-1xx-EZ	12	DDS-5xx-STZ	11	DPM-1xx-LA10Z	23	DRD-4xx-CSZ	5
DAH-1xx-L01Z	12	DDS-5xx-SZ	11	DPM-1xx-LA11Z	23	DRD-4xx-RFZ	9
DAH-1xx-LT01Z	12	DDS-6xx-STZ	10	DPM-1xx-LAT0Z	23	DRD-4xx-RMZ	3
DAH-1xx-LTZ	12	DDS-6xx-SZ	10	DPM-1xx-LAT1Z	23	DRD-4xx-RRZ	7
DAH-1xx-LZ	12	DHS-1xx-LCZ	15	DPM-1xx-LB10Z	23	DRD-4xx-RSZ	5
DAM-1xx-E01Z	13	DHS-1xx-LDZ	15	DPM-1xx-LB11Z	23	DRD-5xx-CFZ	9
DAM-1xx-EZ	13	DHS-1xx-LTZ	15	DPM-1xx-LBT0Z	23	DRD-5xx-CRZ	7
DAM-1xx-L01Z	13	DHS-1xx-LZ	15	DPM-1xx-LBT1Z	23	DRD-5xx-CSZ	5
DAM-1xx-LT01Z	13	DPA-1xx-EA00Z	22	DPS-1xx-ATZ	18	DRD-5xx-RFZ	9
DAM-1xx-LTZ	13	DPA-1xx-EA10Z	22	DPS-1xx-AZ	18	DRD-5xx-RRZ	7
DAM-1xx-LZ	13	DPA-1xx-LA00Z	22	DPS-1xx-BTZ	18	DRD-5xx-RSZ	5
DDG-1xx-LTZ	11	DPA-1xx-LA10Z	22	DPS-1xx-BZ	18	DSD-1xx-EZ	14
DDG-1xx-SRAZ	11	DPA-1xx-LAT0Z	22	DPS-2xx-ATZ	18	DSD-1xx-LCZ	14
DDG-1xx-STZ	11	DPA-1xx-LAT1Z	22	DPS-2xx-AZ	18	DSD-1xx-LDZ	14
DDG-1xx-SZ	11	DPG-1xx-ATZ	18	DPS-2xx-BTZ	18	DSD-1xx-LTZ	14
DDG-2xx-STZ	10	DPG-1xx-AZ	18	DPS-2xx-BZ	18	DSD-1xx-LZ	14
DDG-2xx-SZ	10	DPG-1xx-BTZ	18	DPS-3xx-ATZ	18	DSL-1xx-EZ	14
DDG-3xx-STZ	10	DPG-1xx-BZ	18	DPS-3xx-AZ	18	DSL-1xx-LCZ	14
DDG-3xx-SZ	10	DPG-2xx-ATZ	18	DPS-3xx-BTZ	18	DSL-1xx-LDZ	14
DDG-4xx-LTZ	11	DPG-2xx-AZ	18	DPS-3xx-BZ	18	DSL-1xx-LTZ	14
DDG-4xx-LZ	11	DPG-2xx-BTZ	18	DPS-4xx-ATZ	19	DSL-1xx-LZ	14
DDG-4xx-SRAZ	11	DPG-2xx-BZ	18	DPS-4xx-AZ	19	DSP-42-E01Z	17
DDG-4xx-STZ	11	DPG-3xx-ATZ	18	DPS-4xx-BTZ	19	DSP-42-E02Z	17
DDG-4xx-SZ	11	DPG-3xx-AZ	18	DPS-4xx-BZ	19	DSP-42-EC02Z	17
DDG-5xx-LTZ	11	DPG-3xx-BTZ	18	DPS-5xx-ATZ	19	DSP-42-L01Z	17
DDG-5xx-LZ	11	DPG-3xx-BZ	18	DPS-5xx-AZ	19	DSP-42-L02Z	17
DDG-5xx-SRAZ	11	DPG-4xx-ATZ	19	DPS-5xx-BTZ	19	DSP-42-LC02Z	17
DDG-5xx-STZ	11	DPG-4xx-AZ	19	DPS-5xx-BZ	19	DSP-42-LD02Z	17
DDG-5xx-SZ	11	DPG-4xx-BTZ	19	DPS-6xx-ATZ	19	DSP-42-LT01Z	17
DDG-6xx-STZ	10	DPG-4xx-BZ	19	DPS-6xx-AZ	19	DSP-42-LT02Z	17
DDG-6xx-SZ	10	DPG-5xx-ATZ	19	DPS-6xx-BTZ	19	DSS-1010Z	2
DDS-1xx-LTZ	11	DPG-5xx-AZ	19	DPS-6xx-BZ	19	DSS-2010Z	2
DDS-1xx-LZ	11	DPG-5xx-BTZ	19	DRD-1xx-CFZ	8	DSS-3020Z	2
DDS-1xx-SRAZ	11	DPG-5xx-BZ	19	DRD-1xx-CMZ	3	DSS-4020KDZ	2
DDS-1xx-STZ	11	DPG-6xx-ATZ	19	DRD-1xx-CRZ	6	DSS-4020Z	2
DDS-1xx-SZ	11	DPG-6xx-AZ	19	DRD-1xx-CSZ	4	DTA-1xx-ETZ	16
DDS-2xx-STZ	10	DPG-6xx-BTZ	19	DRD-1xx-RFZ	8	DTA-1xx-EZ	16
DDS-2xx-SZ	10	DPG-6xx-BZ	19	DRD-1xx-RMZ	3	DTA-1xx-LTZ	16
DDS-3xx-STZ	10	DPH-1xx-EAZ	20	DRD-1xx-RRZ	6	DTA-1xx-LZ	16
DDS-3xx-SZ	10	DPH-1xx-LATZ	20	DRD-1xx-RSZ	4	DTD-1xx-ETZ	16
DDS-4xx-LTZ	11	DPH-1xx-LAZ	20	DRD-2xx-CFZ	8	DTD-1xx-EZ	16
DDS-4xx-LZ	11	DPI-1xx-EA10Z	21	DRD-2xx-CRZ	6	DTS-1xx-ETZ	16
DDS-4xx-SRAZ	11	DPI-1xx-EB10Z	21	DRD-2xx-CSZ	4	DTS-1xx-EZ	16
DDS-4xx-STZ	11	DPI-1xx-LA10Z	21	DRD-2xx-RFZ	8	DTS-1xx-LTZ	16
DDS-4xx-SZ	11	DPI-1xx-LB10Z	21	DRD-2xx-RRZ	6	DTS-1xx-LZ	16
DDS-5xx-LTZ	11	DPM-1xx-EA10Z	23	DRD-2xx-RSZ	4		
DDS-5xx-LZ	11	DPM-1xx-EA11Z	23	DRD-4xx-CFZ	9		
		DPM-1xx-EB10Z	23	DRD-4xx-CMZ	3		

Changeover Slide Switch

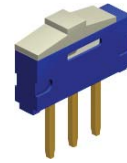
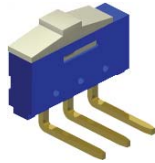

SMT & THT Page 2

Rotary Switch

horizontal SMT

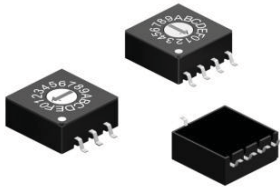

Page 3

horizontal THT

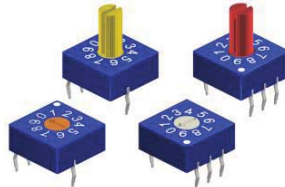

Page 4 & 5

vertical THT

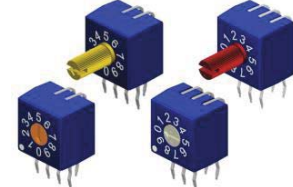

Page 6 to 9

Slide Switch

DIP Package "THT"

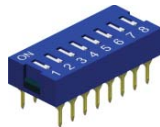
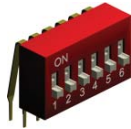
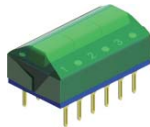
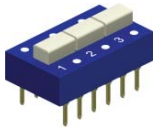

DDG / DDS Series Page 10 & 11

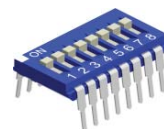
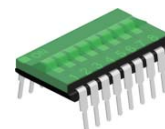
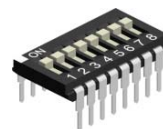

DAH / DAM Series Page 12 & 13

DIP Package "SMT"

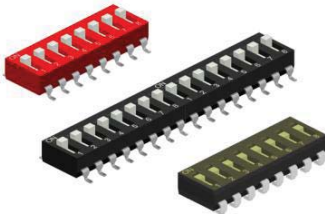

DSD / DSL Series Page 14

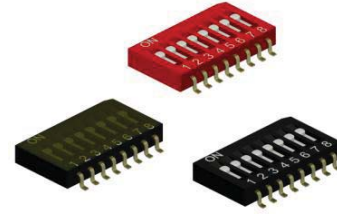

DHS Series Page 15

TRI-State "THT" & "SMT"

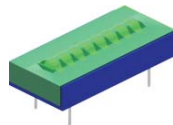
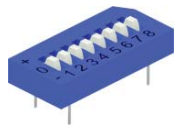

DTD / DTA / DTS Series Page 16

Selector "THT" & "SMT"

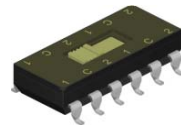
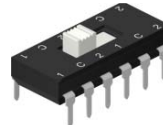

DSP Series Page 17

Piano Switch

DIP Package "THT"

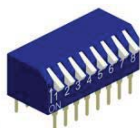

DPG / DPS Series Page 18 & 19

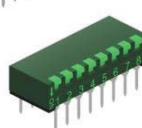
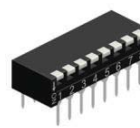
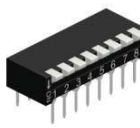

DPH / DPI Series Page 20 & 21

DIP Package "SMT"

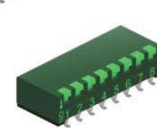





DPA / DPM Series Page 22 & 23

DSS Series

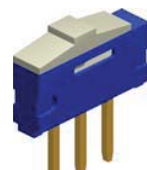
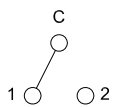
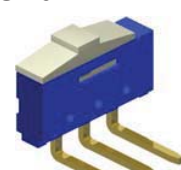
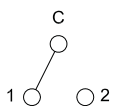
CHANGEOVER SLIDE SWITCH "THT" & "SMT" TYPE

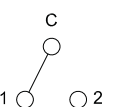

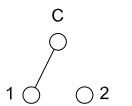
<p>DSS-10xx</p> 		<p>Circuit diagram</p> 	<p>Switch position</p> <table border="0"> <tr> <td>(B)</td> <td>(A)</td> </tr> <tr> <td>PT</td> <td>PT</td> </tr> <tr> <td>C-1</td> <td>C-2</td> </tr> </table>	(B)	(A)	PT	PT	C-1	C-2	<p>PCB Hole Layout</p>
(B)	(A)									
PT	PT									
C-1	C-2									
<p>DSS-20xx</p> 		<p>Circuit diagram</p> 	<p>Switch position</p> <table border="0"> <tr> <td>(B)</td> <td>(A)</td> </tr> <tr> <td>PT</td> <td>PT</td> </tr> <tr> <td>C-1</td> <td>C-2</td> </tr> </table>	(B)	(A)	PT	PT	C-1	C-2	<p>PCB Hole Layout</p>
(B)	(A)									
PT	PT									
C-1	C-2									
<p>DSS-30xx</p> 		<p>Circuit diagram</p> 	<p>Switch position</p> <table border="0"> <tr> <td>(B)</td> <td>(A)</td> </tr> <tr> <td>PT</td> <td>PT</td> </tr> <tr> <td>C-1</td> <td>C-2</td> </tr> </table>	(B)	(A)	PT	PT	C-1	C-2	<p>PCB SMT Layout</p>
(B)	(A)									
PT	PT									
C-1	C-2									
<p>DSS-40xx</p> 		<p>Circuit diagram</p> 	<p>Switch position</p> <table border="0"> <tr> <td>(B)</td> <td>(A)</td> </tr> <tr> <td>PT</td> <td>PT</td> </tr> <tr> <td>C-1</td> <td>C-2</td> </tr> </table>	(B)	(A)	PT	PT	C-1	C-2	<p>PCB SMT Layout</p>
(B)	(A)									
PT	PT									
C-1	C-2									

SPECIFICATIONS

Electrical data

Contact Rating	0.2A, 24V DC / 0.5A, 12V DC
-switching	1 mA at 10mV
-minimum	
Contact Resistance	50 mΩ max.
-after life test	100 mΩ max.
Insulation Resistance	10000 MΩ min. at 500V DC
Withstanding Voltage	500 V AC for 1 Minute
Capacitance between adjacent switches	1.5 pF max.

Mechanical and Environmental data

Operating Temperature	-25°C to +70°C
Storage Temperature	-40°C to +85°C
Soldering Temperature	
-SMT reflow soldering	250°C +0/-5°C for 10 sec. max.
-THT wave soldering	250°C +0/-5°C for 10 sec. max.
Operating force	800 gf max.
Mechanical Life	5000 operations
Vibration	10 Hz – 50 Hz – 10 Hz for 6 hours

FEATURES

- Suitable for signal switching and communication equipments
- All plastics used are UL 94V-0 grade fire retardant
- Gold plated contacts to ensure low contact resistance
- Tropical Version (black color) also for THT straight and right angle type available



How to order

DSS – xx xx XX Z

Type	
10	= Straight THT
20	= Right angle THT
<i>Tropical version only:</i>	
30	= Vertical SMT
40	= Horizontal SMT

Execution	
10	= Standard version (blue) Material: Nylon 66
20	= Tropical version (black) Material: Nylon 9T

Packing option	
blank	= Tube packing
KD	= Reel packing for DSP-40xx series only

DRD-1 xx-XM Z (3:3 pin-out)



16 POSITIONS

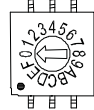

10 POSITIONS

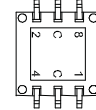
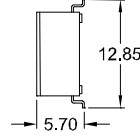
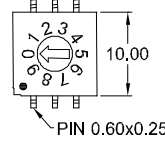

8 POSITIONS

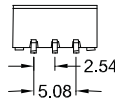
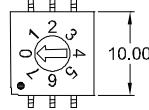

Pin No.	POSITION															
	0	1	2	3	4	5	6	7	8	9	A	B	C	D	E	F
1	○	●	○	●	○	●	○	●	○	●	○	●	○	●	○	●
2	○	○	○	○	○	○	○	○	○	○	○	○	○	○	○	○
4	○	○	○	○	○	○	○	○	○	○	○	○	○	○	○	○
8	○	○	○	○	○	○	○	○	○	○	○	○	○	○	○	○

● Real Code Rotor color: White
○ Complementary Code Rotor color: Red

DRD-4 xx-XM Z (1:4 pin-out)

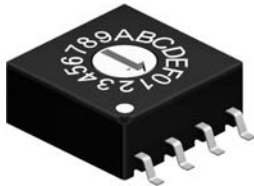

16 POSITIONS

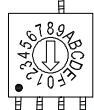

10 POSITIONS

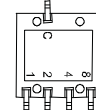
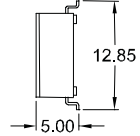
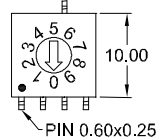

8 POSITIONS

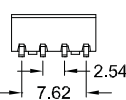
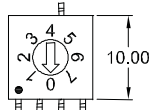

Pin No.	POSITION															
	0	1	2	3	4	5	6	7	8	9	A	B	C	D	E	F
1	○	○	○	○	○	○	○	○	○	○	○	○	○	○	○	○
2	○	○	○	○	○	○	○	○	○	○	○	○	○	○	○	○
4	○	○	○	○	○	○	○	○	○	○	○	○	○	○	○	○
8	○	○	○	○	○	○	○	○	○	○	○	○	○	○	○	○

● Real Code Rotor color: Yellow
○ Complementary Code Rotor color: Orange

Construction

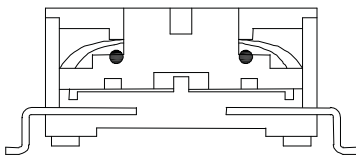

PCB SMT Layout

3:3 PIN-OUT

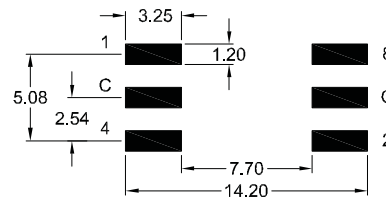

1:4 PIN-OUT

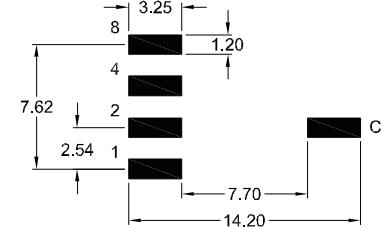

SPECIFICATIONS

Electrical data

Contact Rating	
-switching	25 mA, 24 V DC
-non-switching	100 mA, 50 V DC
Contact Resistance	
-initial	50 mΩ max.
-after life test	100 mΩ max.
Insulation Resistance	1000 MΩ min. at 100 V DC
Withstanding Voltage	250 V AC for 1 Minute

Mechanical and Environmental data

Operating Temperature	-25°C to +70°C
Storage Temperature	-40°C to +85°C
Soldering Temperature	
-SMT reflow soldering	250°C +0/-5°C for 10 sec.
Operating Force	500 gf-cm max. (torque)
Mechanical Life	2000 steps per position
Vibration	10 Hz – 50 Hz – 10 Hz for 6 hours

FEATURES

- Molded-in terminals and fully sealed construction
- Standard 2.54mm pin to pin
- All plastics are UL 94V-0 grade fire retardant
- Reliable contact and long-term stability
- Binary decimal (8 or 10 positions) and hexadecimal (16 positions), real and complementary codes available
- Gold plated contacts to ensure low contact resistance. Terminals Tin plated.

How to order

DRD – x xx – XX Z

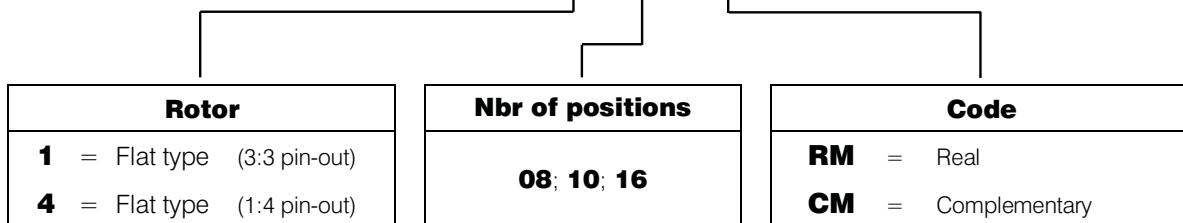

DRD Series 10x10 Size sealed ROTARY TYPE
 3:3 PIN-OUT STRAIGHT "THT" (2.54 x 7.62mm footprint)



DRD-1 xx-XS Z (Flat Type)

Dimensions: 5.08mm, 2.54mm, PIN 0.60x0.25, 5.00mm, 3.50mm, 7.62mm, 5.40mm, 10.00mm

DRD-2 xx-XS Z (Shaft Type)

Dimensions: 5.08mm, 2.54mm, PIN 0.60x0.25, 7.00mm, 5.00mm, 3.50mm, 7.62mm, 5.40mm, 10.00mm, 1.50mm, $\phi 3.75$

Construction

PCB Hole Layout

Code

Pin No.	POSITION															
	0	1	2	3	4	5	6	7	8	9	A	B	C	D	E	F
1	○	●	○	○	○	○	○	○	○	○	○	○	○	○	○	○
2	○	○	○	○	○	○	○	○	○	○	○	○	○	○	○	○
4	○	○	○	○	○	○	○	○	○	○	○	○	○	○	○	○
8	○	○	○	○	○	○	○	○	○	○	○	○	○	○	○	○

● Real Code Rotor color: White
 ○ Complementary Code Rotor color: Red

SPECIFICATIONS

Electrical data

Contact Rating	25 mA, 24 V DC
-switching	100 mA, 50 V DC
Contact Resistance	50 mΩ max.
-initial	100 mΩ max.
-after life test	1000 MΩ min. at 100 V DC
Insulation Resistance	250 V AC for 1 Minute
Withstanding Voltage	

Mechanical and Environmental data

Operating Temperature	-25°C to +70°C
Storage Temperature	-40°C to +85°C
Operating Force	500 gf-cm max. (torque)
Mechanical Life	2000 steps per position
Vibration	10 Hz – 50 Hz – 10 Hz for 6 hours

FEATURES

- Molded-in terminals and fully sealed construction
- Standard 2.54mm pin to pin
- All plastics are UL 94V-0 grade fire retardant
- Reliable contact and long-term stability
- Binary decimal (8 or 10 positions) and hexadecimal (16 positions), real and complementary codes available
- Gold plated contacts to ensure low contact resistance. Terminals Tin plated.

How to order

DRD – x xx – XX Z

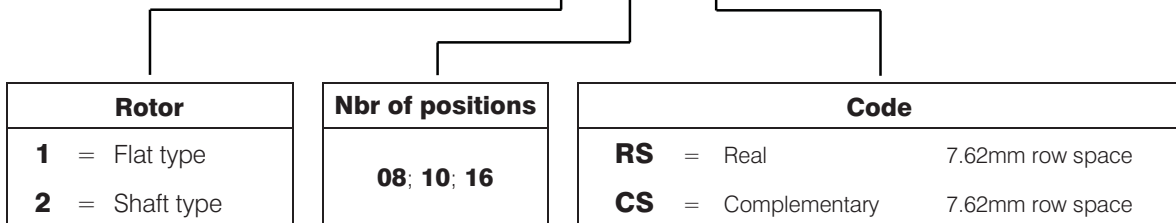

DRD-4 xx-XS Z (Flat Type)

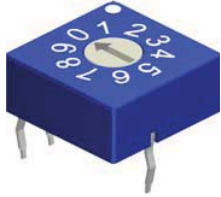

10 POSITIONS



8 POSITIONS

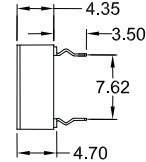
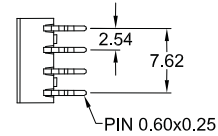
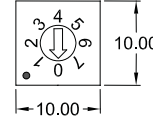

DRD-5 xx-XS Z (Shaft Type)

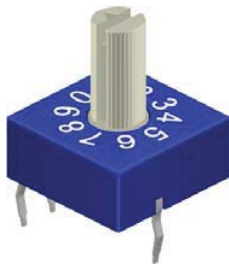

16 POSITIONS



10 POSITIONS



8 POSITIONS

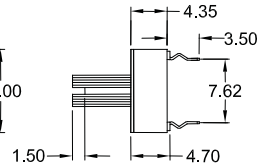
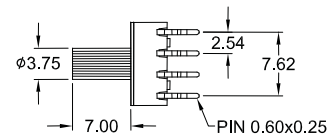
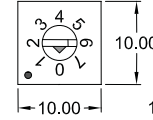

Construction

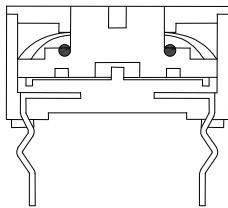

PCB Hole Layout

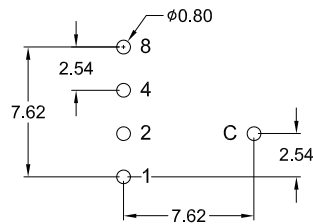

Code

Pin No.	POSITION															
	0	1	2	3	4	5	6	7	8	9	A	B	C	D	E	F
1	○	●	○	●	○	●	○	●	○	●	○	●	○	●	○	●
2	○	○	●	●	○	○	●	●	○	○	●	●	○	○	●	●
4	○	○	○	○	○	○	○	○	○	○	○	○	○	○	○	○
8	○	○	○	○	○	○	○	○	○	○	○	○	○	○	○	○

● Real Code Rotor color: Yellow
 ○ Complementary Code Rotor color: Orange

SPECIFICATIONS

Electrical data

Contact Rating	
-switching	25 mA, 24 V DC
-non-switching	100 mA, 50 V DC
Contact Resistance	
-initial	50 mΩ max.
-after life test	100 mΩ max.
Insulation Resistance	1000 MΩ min. at 100 V DC
Withstanding Voltage	250 V AC for 1 Minute

Mechanical and Environmental data

Operating Temperature	-25°C to +70°C
Storage Temperature	-40°C to +85°C
Operating Force	500 gf-cm max. (torque)
Mechanical Life	2000 steps per position
Vibration	10 Hz – 50 Hz – 10 Hz for 6 hours

FEATURES

- Molded-in terminals and fully sealed construction
- Standard 2.54mm pin to pin
- All plastics are UL 94V-0 grade fire retardant
- Reliable contact and long-term stability
- Binary decimal (8 or 10 positions) and hexadecimal (16 positions), real and complementary codes available
- Gold plated contacts to ensure low contact resistance. Terminals Tin plated.

How to order

DRD – x xx – XX Z

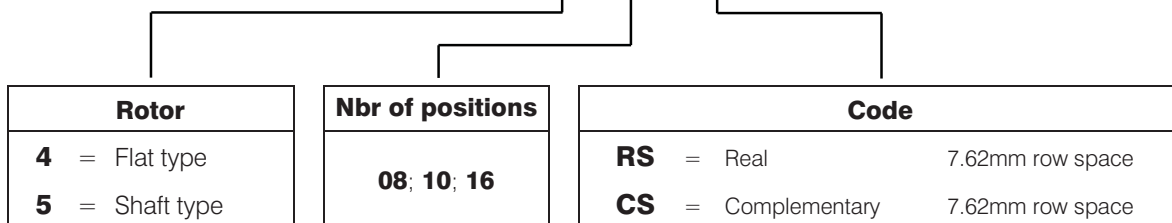

DRD-1 xx-XR Z (Flat Type)



16 POSITIONS



10 POSITIONS

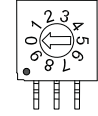

8 POSITIONS

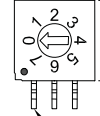

PIN 0.60x0.25

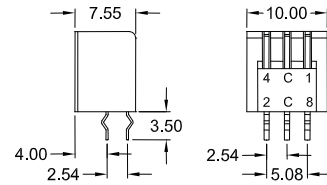

DRD-2 xx-XR Z (Shaft Type)



16 POSITIONS



10 POSITIONS

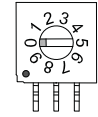

8 POSITIONS

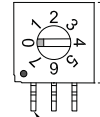

PIN 0.60x0.25

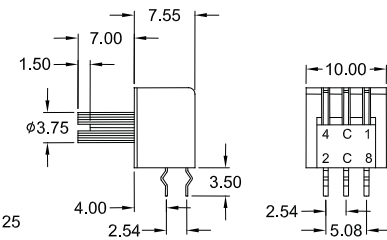

Construction

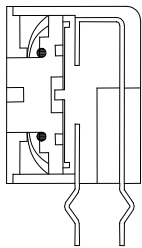

PCB Hole Layout

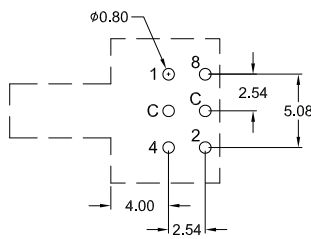

Code

Pin No.	POSITION															
	0	1	2	3	4	5	6	7	8	9	A	B	C	D	E	F
1	○	●	○	●	○	●	○	●	○	●	○	●	○	●	○	●
2	○	○	○	○	○	○	○	○	○	○	○	○	○	○	○	○
4	○	○	○	○	○	○	○	○	○	○	○	○	○	○	○	○
8	○	○	○	○	○	○	○	○	○	○	○	○	○	○	○	○

● Real Code Rotor color: White
 ○ Complementary Code Rotor color: Red

SPECIFICATIONS

Electrical data

Contact Rating	
-switching	25 mA, 24 V DC
-non-switching	100 mA, 50 V DC
Contact Resistance	
-initial	50 mΩ max.
-after life test	100 mΩ max.
Insulation Resistance	1000 MΩ min. at 100 V DC
Withstanding Voltage	250 V AC for 1 Minute

Mechanical and Environmental data

Operating Temperature	- 25°C to +70°C
Storage Temperature	- 40°C to +85°C
Operating Force	500 gf-cm max. (torque)
Mechanical Life	2000 steps per position
Vibration	10 Hz – 50 Hz – 10 Hz for 6 hours

FEATURES

- Molded-in terminals and fully sealed construction
- Standard 2.54mm grid dimension
- All plastics are UL 94V-0 grade fire retardant
- Reliable contact and long-term stability
- Binary decimal (8 or 10 positions) and hexadecimal (16 positions), real and complementary codes available
- Gold plated contacts to ensure low contact resistance. Terminals Tin plated.

How to order

DRD – x xx – XX Z

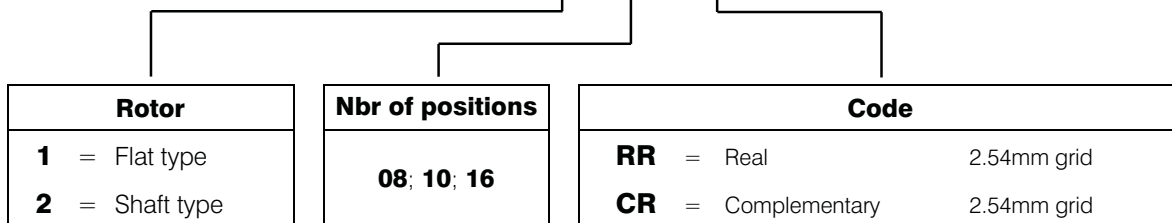

DRD-4 xx-XR Z (Flat Type)



16 POSITIONS

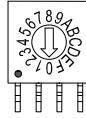

10 POSITIONS

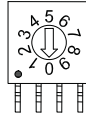

8 POSITIONS

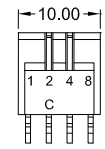
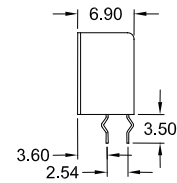
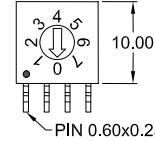

DRD-5 xx-XR Z (Shaft Type)

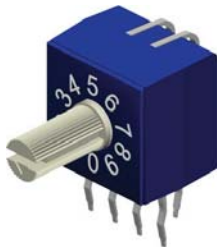

16 POSITIONS

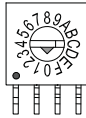

10 POSITIONS

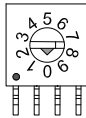

8 POSITIONS

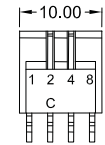
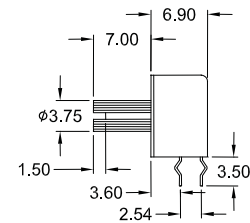
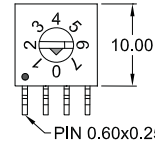

Construction

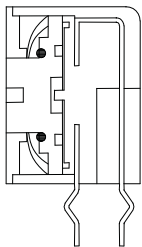

PCB Hole Layout

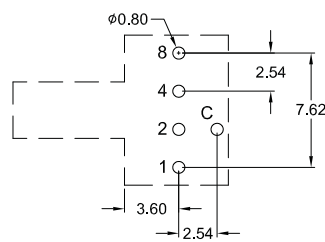

Code

Pin No.	POSITION															
	0	1	2	3	4	5	6	7	8	9	A	B	C	D	E	F
1	○	●	○	●	○	●	○	●	○	●	○	●	○	●	○	●
2	○	○	●	●	○	○	●	●	○	○	●	●	○	○	●	●
4	○	○	○	○	○	○	○	○	○	○	○	○	○	○	○	○
8	○	○	○	○	○	○	○	○	○	○	○	○	○	○	○	○

● Real Code

○ Complementary Code

Rotor color: Yellow

Rotor color: Orange

SPECIFICATIONS

Electrical data

Contact Rating	
-switching	25 mA, 24 V DC
-non-switching	100 mA, 50 V DC
Contact Resistance	
-initial	50 mΩ max.
-after life test	100 mΩ max.
Insulation Resistance	1000 MΩ min. at 100 V DC
Withstanding Voltage	250 V AC for 1 Minute

Mechanical and Environmental data

Operating Temperature	-25°C to +70°C
Storage Temperature	-40°C to +85°C
Operating Force	500 gf-cm max. (torque)
Mechanical Life	2000 steps per position
Vibration	10 Hz – 50 Hz – 10 Hz for 6 hours

FEATURES

- Molded-in terminals and fully sealed construction
- Standard 2.54mm grid dimension
- All plastics are UL 94V-0 grade fire retardant
- Reliable contact and long-term stability
- Binary decimal (8 or 10 positions) and hexadecimal (16 positions), real and complementary codes available
- Gold plated contacts to ensure low contact resistance. Terminals Tin plated.

How to order

DRD – x xx – XX Z

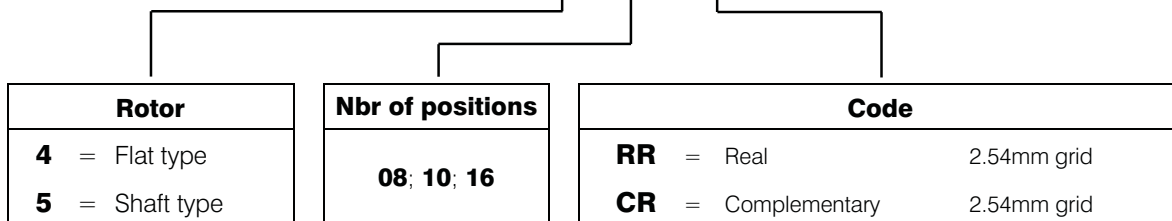

DRD-1 xx-XF Z (Flat Type)



16 POSITIONS

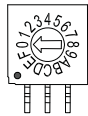

10 POSITIONS

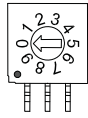

8 POSITIONS

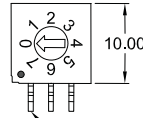

PIN 0.60x0.25

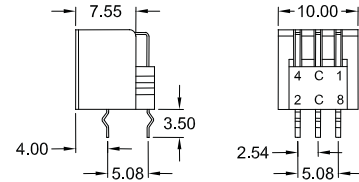

DRD-2 xx-XF Z (Shaft Type)

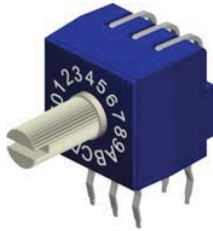

16 POSITIONS

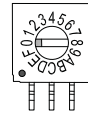

10 POSITIONS

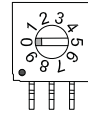

8 POSITIONS

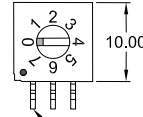

PIN 0.60x0.25

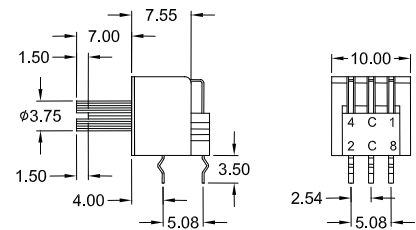

Construction

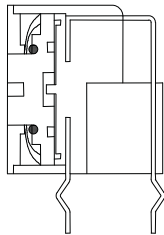

PCB Hole Layout

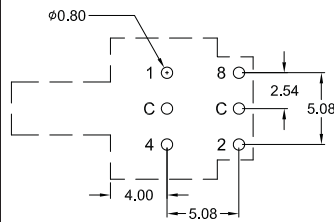

Code

Pin No.	POSITION															
	0	1	2	3	4	5	6	7	8	9	A	B	C	D	E	F
1	○	○	●	○	○	○	○	○	○	○	○	○	○	○	○	○
2	○	○	○	○	○	○	○	○	○	○	○	○	○	○	○	○
4	○	○	○	○	○	○	○	○	○	○	○	○	○	○	○	○
8	○	○	○	○	○	○	○	○	○	○	○	○	○	○	○	○

● Real Code Rotor color: White
 ○ Complementary Code Rotor color: Red

SPECIFICATIONS

Electrical data

Contact Rating	
-switching	25 mA, 24 V DC
-non-switching	100 mA, 50 V DC
Contact Resistance	
-initial	50 mΩ max.
-after life test	100 mΩ max.
Insulation Resistance	1000 MΩ min. at 100 V DC
Withstanding Voltage	250 V AC for 1 Minute

Mechanical and Environmental data

Operating Temperature	-25°C to +70°C
Storage Temperature	-40°C to +85°C
Operating Force	500 gf-cm max. (torque)
Mechanical Life	2000 steps per position
Vibration	10 Hz – 50 Hz – 10 Hz for 6 hours

FEATURES

- Molded-in terminals and fully sealed construction
- Standard 2.54mm pin to pin
- All plastics are UL 94V-0 grade fire retardant
- Reliable contact and long-term stability
- Binary decimal (8 or 10 positions) and hexadecimal (16 positions), real and complementary codes available
- Gold plated contacts to ensure low contact resistance. Terminals Tin plated.

How to order

DRD – x xx – XX Z

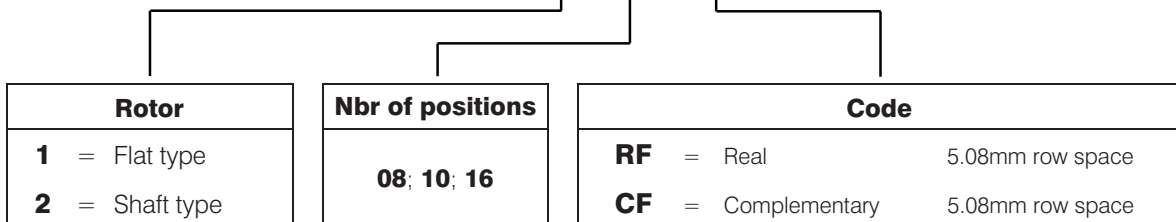

DRD-4 xx-XF Z (Flat Type)



16 POSITIONS

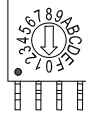

10 POSITIONS

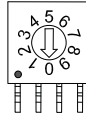

8 POSITIONS

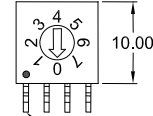

PIN 0.60x0.25

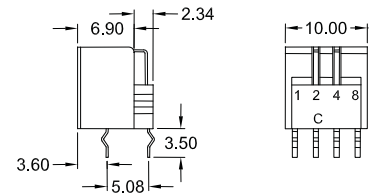

DRD-5 xx-XF Z (Shaft Type)

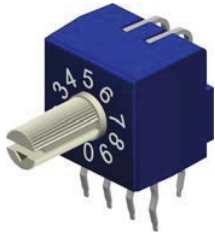

16 POSITIONS

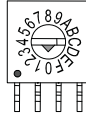

10 POSITIONS

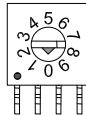

8 POSITIONS

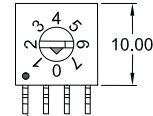

PIN 0.60x0.25

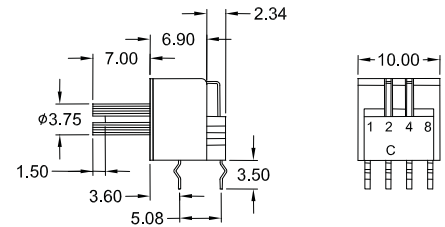

Construction

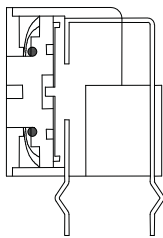

PCB Hole Layout

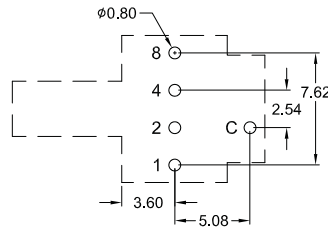

Code

Pin No.	POSITION															
	0	1	2	3	4	5	6	7	8	9	A	B	C	D	E	F
1	○	●	○	●	○	●	○	●	○	●	○	●	○	●	○	●
2	○	○	●	○	○	○	○	○	○	○	○	○	○	○	○	○
4	○	○	○	○	○	○	○	○	○	○	○	○	○	○	○	○
8	○	○	○	○	○	○	○	○	○	○	○	○	○	○	○	○

● Real Code Rotor color: Yellow
○ Complementary Code Rotor color: Orange

SPECIFICATIONS

Electrical data

Contact Rating	
-switching	25 mA, 24 V DC
-non-switching	100 mA, 50 V DC
Contact Resistance	
-initial	50 mΩ max.
-after life test	100 mΩ max.
Insulation Resistance	1000 MΩ min. at 100 V DC
Withstanding Voltage	250 V AC for 1 Minute

Mechanical and Environmental data

Operating Temperature	-25°C to +70°C
Storage Temperature	-40°C to +85°C
Operating Force	500 gf-cm max. (torque)
Mechanical Life	2000 steps per position
Vibration	10 Hz – 50 Hz – 10 Hz for 6 hours

FEATURES

- Molded-in terminals and fully sealed construction
- Standard 2.54mm pin to pin
- All plastics are UL 94V-0 grade fire retardant
- Reliable contact and long-term stability
- Binary decimal (8 or 10 positions) and hexadecimal (16 positions), real and complementary codes available
- Gold plated contacts to ensure low contact resistance. Terminals Tin plated.

How to order

DRD – x xx – XX Z

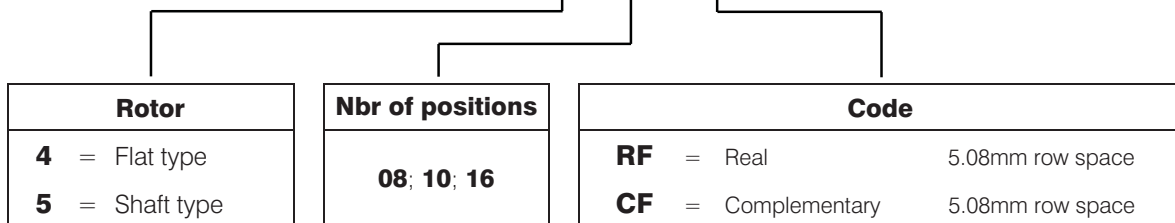



DPDT Contact Form Standard Actuator only!

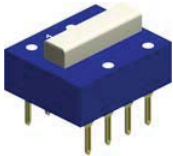

Position	1	2	3
Dim. "A"	11.70	21.70	31.80

Unit: mm

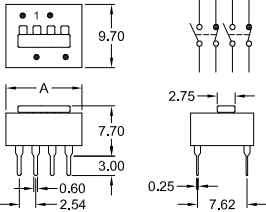

DPST Contact Form Standard Actuator only!

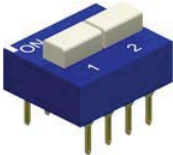

Position	1	2	3	4	5	6
Dim. "A"	6.70	11.70	16.70	21.70	26.70	31.80

Unit: mm

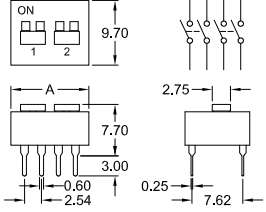

SPDT Contact Form Standard Actuator only!

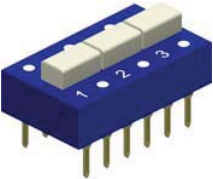

Position	1	2	3	4	5	6
Dim. "A"	6.70	11.70	16.70	21.70	26.70	31.80

Unit: mm

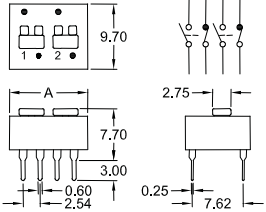

Construction 	Options 1. Special top and/or side marking available  2. Tape sealed 	PCB Hole Layout 
---	---	--

SPECIFICATIONS	
Electrical data Contact Rating -switching 25 mA, 24 V DC -non-switching 100 mA, 50 V DC Contact Resistance -initial 50 mΩ max. -after life test 100 mΩ max. Insulation Resistance 1000 MΩ min. at 100 V DC Withstanding Voltage 500 V AC for 1 Minute Capacitance between adjacent switches 5 pF max.	Mechanical and Environmental data Operating temperature - 25°C to +70°C Storage temperature - 40°C to +85°C Operating force 800 gf max. Mechanical life 2000 operations Vibration 10 Hz – 50 Hz – 10 Hz for 6 hours

FEATURES

- Tactile response is performed directly by larger contact pressure to ensure very stable contact
- All plastics used are UL 94V-0 grade fire retardant
- Bottom epoxy sealed standard
- Contact wiping on make and break
- Gold plated (*gold/gold*) or silver plated (*silver/tin*) contacts to ensure low contact resistance and long mechanical life
- Ideal for Data Processing, Telecommunication, Remote Control and Burglar Alarm System use, where manual programming is required
- Standard packing method Tube

How to order

DDX – x xx – XX Z

Series DDG = Gold plated Contacts DDS = Silver plated Contacts	Contact Form 2 = DPST 3 = SPDT 6 = DPDT	Nbr of positions see under position/dimension box above Example: 1 Position = 01 2 Position = 02 etc.	Actuator and Sealing S = Standard Actuator ST = Standard Actuator & Tape sealed
---	--	---	--

DDG / DDS Series

SLIDE STANDARD PROFILE "THT" TYPE



3PST Contact Form Standard Actuator only!

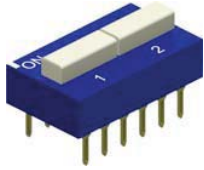

Position	1	2	3	4
Dim. "A"	9.20	16.70	24.20	31.80

Unit: mm

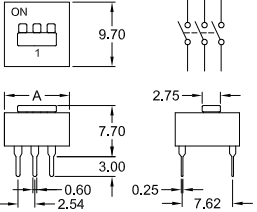

4PST Contact Form Standard Actuator only!

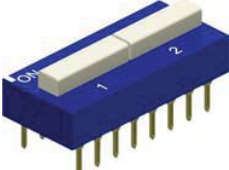

Position	1	2	3
Dim. "A"	11.70	21.70	31.80

Unit: mm

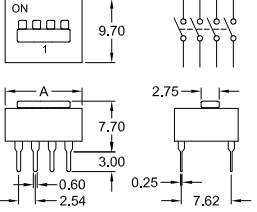

SPST Contact Form Standard & Low Actuator possible.

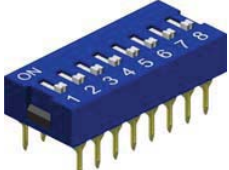

Position	1	2	3	4	5	6
Dim. "A"	3.91	6.70	9.20	11.70	14.20	16.70
Position	7	8	9	10	12	15
Dim. "A"	19.20	21.70	24.20	26.70	31.80	39.50

Unit: mm

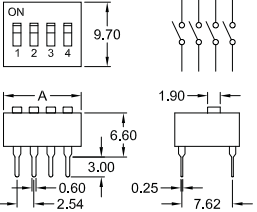

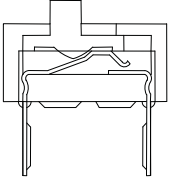
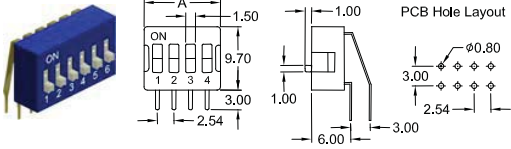
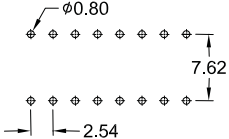
Construction	Options	PCB Hole Layout
	<p>1. Right Angle for <i>SPST</i> Contact Form; 1 to 15 positions</p>  <p>2. Low profile actuator</p> <p>3. Tape sealed</p>	

SPECIFICATIONS

Electrical data

Contact Rating	25 mA, 24 V DC
-switching	100 mA, 50 V DC
-non-switching	
Contact Resistance	
-initial	50 mΩ max.
-after life test	100 mΩ max.
Insulation Resistance	1000 MΩ min. at 100 V DC
Withstanding Voltage	500 V AC for 1 Minute
Capacitance between adjacent switches	5 pF max.

Mechanical and Environmental data

Operating temperature	-25°C to +70°C
Storage temperature	-40°C to +85°C
Operating force	800 gf max.
Mechanical life	2000 operations
Vibration	10 Hz – 50 Hz – 10 Hz for 6 hours

FEATURES

- Tactile response is performed directly by larger contact pressure to ensure very stable contact
- All plastics used are UL 94V-0 grade fire retardant
- Bottom epoxy sealed standard
- Contact wiping on make and break
- Gold plated (*gold/gold*) or silver plated (*silver/tin*) contacts to ensure low contact resistance and long mechanical life
- Ideal for Data Processing, Telecommunication, Remote Control and Burglar Alarm System use, where manual programming is required
- Standard packing method Tube

How to order

DDX – x xx – XXX Z

Series	Contact Form	Nbr of positions	Actuator and Sealing
DDG = Gold plated Contacts	1 = SPST	see under position/dimension box above	S = Standard Actuator
DDS = Silver plated Contacts	4 = 3PST	Example: 1 Position = 01 2 Position = 02 etc.	L = Low Profile Actuator
	5 = 4PST		LT = Low Profile Actuator & Tape sealed
			ST = Standard Actuator & Tape sealed
			SRA = Right Angle Type

DAH Series

SLIDE AUTO INSERTING "THT" TYPE



Position	2	3	4	5	6	7	8	10	12
Dim. "A"	6.68	9.42	11.96	14.50	17.04	19.58	22.12	27.20	32.28

Unit: mm

Construction

Options

- Two kinds of pitch available as attached table
- Special marking and body color available
- Tape sealed

Actuator Type	Pitch(mm)	
	Standard	Option
E	7.62	8.50
L	8.50	7.62

SPECIFICATIONS

Electrical data		Mechanical and Environmental data	
Contact Rating	25 mA, 24 V DC	Operating temperature	-25°C to +70°C
-switching	100 mA, 50 V DC	Storage temperature	-40°C to +85°C
-non-switching		Operating force	800 gf max.
Contact Resistance	50 mΩ max.	Mechanical life	2000 operations
-initial	100 mΩ max.	Vibration	10 Hz – 50 Hz – 10 Hz for 6 hours
-after life test	1000 MΩ min. at 100 V DC		
Insulation Resistance	500 V AC for 1 Minute		
Withstanding Voltage	5 pF max.		
Capacitance between adjacent switches			

FEATURES

<ul style="list-style-type: none"> Same size as an IC, 7.62mm (.300"), can be assembled by any automatic IC Inserter Smaller size makes better heat convection during PC board wave soldering Tape sealed to withstand solder vapors and board washing 	<ul style="list-style-type: none"> All plastics used are UL 94V-0 grade fire retardant Twin contact design to ensure stable contact Gold plated contacts to ensure low contact resistance, and tin plated terminal to prevent contamination during soldering (<i>gold/tin</i>) Standard packing method Tube
---	---

How to order

DAH – 1 xx – XXxx Z

Contact Form	Nbr of positions	Actuator, Sealing and DIP Space
<p>1 = SPST</p>	<p>see under position/dimension box above</p> <p>Example: 2 Position = 02 3 Position = 03 etc.</p>	<p>L = Low profile Actuator and DIP space 8.50mm</p> <p>LT = Low profile Actuator & Tape sealed & DIP space 8.50mm</p> <p>L01 = Low profile Actuator and DIP space 7.62mm</p> <p>LT01 = Low profile Actuator & Tape sealed & DIP space 7.62mm</p> <p>E = Extended Actuator and DIP space 7.62mm</p> <p>E01 = Extended Actuator and DIP space 8.50mm</p>

DAM Series

SLIDE END STACKABLE "THT" TYPE



all in "ON" position

Extended Actuator

Low Profile Actuator

Circuit diagram

PCB Hole Layout

Position	1	2	3	4	5	6	7	8	9	10	12
Dim. "A"	2.50	5.04	7.58	10.12	12.66	15.20	17.74	20.28	22.82	25.36	30.43

Unit: mm

Construction

Options

- Two kinds of pitch available as attached table
- Special marking and body color available
- Tape sealed

Actuator Type	Pitch(mm)	
	Standard	Option
E	7.62	8.50
L	8.50	7.62

SPECIFICATIONS

Electrical data		Mechanical and Environmental data	
Contact Rating	-switching 25 mA, 24 V DC -non-switching 100 mA, 50 V DC	Operating temperature	-25°C to +70°C
Contact Resistance	-initial 50 mΩ max. -after life test 100 mΩ max.	Storage temperature	-40°C to +85°C
Insulation Resistance	1000 MΩ min. at 100 V DC	Operating force	800 gf max.
Withstanding Voltage	500 V AC for 1 Minute	Mechanical life	2000 operations
Capacitance between adjacent switches	5 pF max.	Vibration	10 Hz – 50 Hz – 10 Hz for 6 hours

FEATURES

- End stackable for standard 2.54mm (.100") integrated circuit pitch
- Same size as an IC, 7.62mm (.300"), can be assembled by any automatic IC Inserter
- Tape sealed to withstand solder vapors and board washing
- All plastics used are UL 94V-0 grade fire retardant
- Twin contact design to ensure stable contact
- Gold plated contacts to ensure low contact resistance, and tin plated terminal to prevent contamination during soldering (*gold/tin*)
- Standard packing method Tube

How to order

DAM – 1 xx – XXxx Z

Contact Form	Nbr of positions	Actuator, Sealing and DIP Space
1 = SPST	see under position/dimension box above Example: 1 Position = 01 2 Position = 02 etc.	L = Low profile Actuator and DIP space 8.50mm LT = Low profile Actuator & Tape sealed & DIP space 8.50mm L01 = Low profile Actuator and DIP space 7.62mm LT01 = Low profile Actuator & Tape sealed & DIP space 7.62mm E = Extended Actuator and DIP space 7.62mm E01 = Extended Actuator and DIP space 8.50mm

DSD / DSL Series

SLIDE END STACKABLE "SMT" TYPE



DSD Gull Wing Type

Low Profile Actuator:

Extended Actuator:

Circuit diagram:

PIN 0.50x0.25

DSL J-Leg Type

Low Profile Actuator:

Extended Actuator:

Circuit diagram:

PIN 0.50x0.25

Position	1	2	3	4	5	6	7	8	9	10	12
Dim. "A"	2.50	5.04	7.58	10.12	12.66	15.20	17.74	20.28	22.82	25.36	30.43

DSL Series: 1 position switch is not available

Unit: mm

Construction	PCB SMT Layout	Options
<p>DSD </p> <p>DSL </p>		<p>1. Special marking and body color available</p> <p>2. Tape sealed</p>

SPECIFICATIONS

Electrical data

Contact Rating	
-switching	25 mA, 24 V DC
-non-switching	100 mA, 50 V DC
Contact Resistance	
-initial	50 mΩ max.
-after life test	100 mΩ max.
Insulation Resistance	1000 MΩ min. at 100 V DC
Withstanding Voltage	500 V AC for 1 Minute
Capacitance between adjacent switches	5 pF max.

Mechanical and Environmental data

Operating Temperature	-25°C to +70°C
Storage Temperature	-40°C to +85°C
Soldering Temperature	
-SMT reflow soldering	250°C +0/-5°C for 10 sec.
Operating Force	800 gf max.
Mechanical Life	2000 operations
Vibration	10 Hz – 50 Hz – 10 Hz for 6 hours

FEATURES

- End stackable for standard 2.54mm (.100") integrated circuit pitch
- Tape sealed to withstand solder vapors and board washing
- All plastics used are UL 94V-0 grade fire retardant
- Twin contact design to ensure stable contact
- Gold plated contacts to ensure low contact resistance, and tin plated terminal to prevent contamination during soldering (*gold/tin*)

How to order

DSX – 1 **xx** – **XX** Z

Series
DSD = Gull Wing Type
DSL = J-Leg Type

Nbr of positions
see under position/dimension box above
Example:
1 Position = 01
2 Position = 02
etc.

Actuator, Sealing and Packing
L = Low Profile Actuator; Tube packing
LT = Low Profile Actuator & Tape sealed; Tube packing
LC = Low Profile Actuator; Reel packing
LD = Low Profile Actuator & Tape sealed; Reel packing
E = Extended Actuator; Tube packing

DHS Series

SLIDE HALF PITCH (1.27mm) "SMT" TYPE



Circuit diagram

Position	2	4	6	8	10
Dim. "A"	3.70	6.20	8.75	11.30	13.80

Unit: mm

Construction

PCB SMT Layout

Options

1. Special marking and body color available

2. Tape sealed

SPECIFICATIONS																																	
<p>Electrical data</p> <table style="width: 100%; border-collapse: collapse;"> <tr> <td style="padding: 2px;">Contact Rating</td> <td></td> </tr> <tr> <td style="padding: 2px;">-switching</td> <td style="padding: 2px;">25 mA, 24 V DC</td> </tr> <tr> <td style="padding: 2px;">-non-switching</td> <td style="padding: 2px;">100 mA, 50 V DC</td> </tr> <tr> <td style="padding: 2px;">Contact Resistance</td> <td></td> </tr> <tr> <td style="padding: 2px;">-initial</td> <td style="padding: 2px;">50 mΩ max.</td> </tr> <tr> <td style="padding: 2px;">-after life test</td> <td style="padding: 2px;">100 mΩ max.</td> </tr> <tr> <td style="padding: 2px;">Insulation Resistance</td> <td style="padding: 2px;">500 MΩ min. at 100 V DC</td> </tr> <tr> <td style="padding: 2px;">Withstanding Voltage</td> <td style="padding: 2px;">300 V AC for 1 Minute</td> </tr> <tr> <td style="padding: 2px;">Capacitance between adjacent switches</td> <td style="padding: 2px;">5 pF max.</td> </tr> </table>	Contact Rating		-switching	25 mA, 24 V DC	-non-switching	100 mA, 50 V DC	Contact Resistance		-initial	50 mΩ max.	-after life test	100 mΩ max.	Insulation Resistance	500 MΩ min. at 100 V DC	Withstanding Voltage	300 V AC for 1 Minute	Capacitance between adjacent switches	5 pF max.	<p>Mechanical and Environmental data</p> <table style="width: 100%; border-collapse: collapse;"> <tr> <td style="padding: 2px;">Operating Temperature</td> <td style="padding: 2px;">-25°C to +70°C</td> </tr> <tr> <td style="padding: 2px;">Storage Temperature</td> <td style="padding: 2px;">-40°C to +85°C</td> </tr> <tr> <td style="padding: 2px;">Soldering Temperature</td> <td></td> </tr> <tr> <td style="padding: 2px;">-SMT reflow soldering</td> <td style="padding: 2px;">250°C +0/-5°C for 10 sec.</td> </tr> <tr> <td style="padding: 2px;">Operating Force</td> <td style="padding: 2px;">800 gf max.</td> </tr> <tr> <td style="padding: 2px;">Mechanical Life</td> <td style="padding: 2px;">1000 operations</td> </tr> <tr> <td style="padding: 2px;">Vibration</td> <td style="padding: 2px;">10 Hz – 50 Hz – 10 Hz for 6 hours</td> </tr> </table>	Operating Temperature	-25°C to +70°C	Storage Temperature	-40°C to +85°C	Soldering Temperature		-SMT reflow soldering	250°C +0/-5°C for 10 sec.	Operating Force	800 gf max.	Mechanical Life	1000 operations	Vibration	10 Hz – 50 Hz – 10 Hz for 6 hours
Contact Rating																																	
-switching	25 mA, 24 V DC																																
-non-switching	100 mA, 50 V DC																																
Contact Resistance																																	
-initial	50 mΩ max.																																
-after life test	100 mΩ max.																																
Insulation Resistance	500 MΩ min. at 100 V DC																																
Withstanding Voltage	300 V AC for 1 Minute																																
Capacitance between adjacent switches	5 pF max.																																
Operating Temperature	-25°C to +70°C																																
Storage Temperature	-40°C to +85°C																																
Soldering Temperature																																	
-SMT reflow soldering	250°C +0/-5°C for 10 sec.																																
Operating Force	800 gf max.																																
Mechanical Life	1000 operations																																
Vibration	10 Hz – 50 Hz – 10 Hz for 6 hours																																

FEATURES

- End stackable for standard 1.27mm (.050") integrated circuit pitch
- Lowest profile DIP Switch, only 1.80mm above PCB
- Tape sealed to withstand solder vapors and board washing

- All plastics used are UL 94V-0 grade fire retardant
- Gold plated contacts, contact & solder area (*gold/gold*), to ensure low contact resistance

How to order

DHS – x xx – XX Z

Contact Form

1 = SPST

Nbr of positions

see under position/dimension box above

Example:
1 Position = **02**
2 Position = **04**
etc.

Actuator, Sealing and Packing

L	= Low Profile Actuator; Tube packing
LT	= Low Profile Actuator & Tape sealed; Tube packing
LC	= Low Profile Actuator; Reel packing
LD	= Low Profile Actuator & Tape sealed; Reel packing

DTD / DTA / DTS Series

SLIDE TRI-STATE "THT" & "SMT" TYPE



DTD

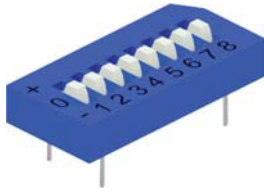

Position	4	5	6	7
Dim. "A"	15.30	17.84	20.38	22.92
Position	8	9	10	
Dim. "A"	25.46	28.00	30.54	

Unit: mm

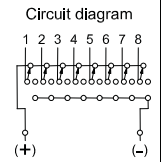
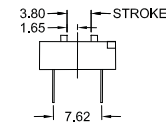
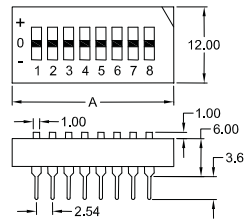

DTA



Position	2	3	4	5
Dim. "A"	6.88	9.42	11.96	14.50
Position	6	7	8	9
Dim. "A"	17.04	19.58	22.12	24.66

Unit: mm

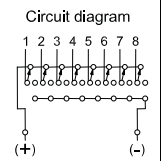
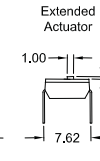
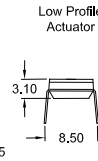
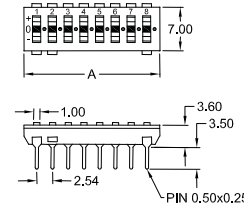

DTS



Position	10	12		
Dim. "A"	27.20	32.28		

Unit: mm

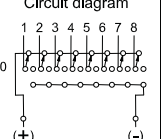
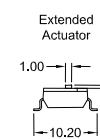
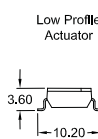
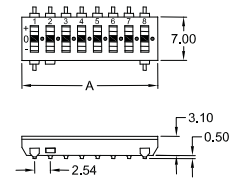

Construction

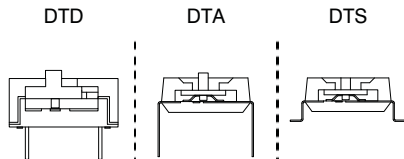

PCB Hole/SMT Layout

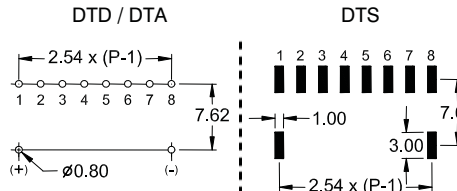

Options

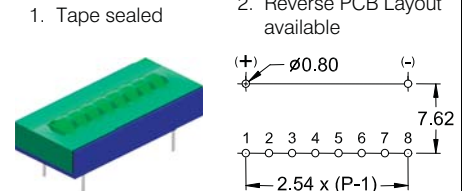

SPECIFICATIONS

Electrical data

Contact Rating	25 mA, 24 V DC
-switching	100 mA, 50 V DC
-non-switching	
Contact Resistance	50 mΩ max.
-initial	100 mΩ max.
-after life test	1000 MΩ min. at 100 V DC
Insulation Resistance	500 V AC for 1 Minute
Withstanding Voltage	5 pF max.
Capacitance between adjacent switches	

Mechanical and Environmental data

Operating temperature	-25°C to +70°C
Storage temperature	-40°C to +85°C
Operating force	800 gf max.
Mechanical life	2000 operations
Vibration	10 Hz – 50 Hz – 10 Hz for 6 hours

FEATURES

- With three state (1-open-0) setting function, especially suitable for encoding/decoding of tri-state encoder/decoder integrated circuit to obtain more security codes than traditional two-state (1-0) operation. For instance, 9 bits with tri-state gets 19,683 (3⁹) codes, while two-state has 512 (2⁹) codes, gains 38 times in former
- All plastics used are UL 94V-0 grade fire retardant
- Gold plated contacts to ensure low contact resistance, and tin plated terminal to prevent contamination during soldering (*gold/tin*)
- Twin contacts designed to ensure stable contact
- Ideal for Telecommunication, Transmitter, Remote Control and Burglar Alarm Systems which use integrated circuits with tri-state coding systems
- Standard packing method Tube

How to order

DTX – 1 **xx** – **XX** Z

Series

DTD	= Bottom Epoxy Sealed THT Type
DTA	= Low Profile THT Type
DTS	= Low Profile SMT Type

Nbr of positions

see under position/dimension box above

Example:
2 Position = **02**
3 Position = **03**
etc.

Actuator and Sealing

E	= Extended Actuator
ET	= Extended Actuator & Tape sealed
<i>Low Profile Actuator for DTA & DTS Series only!</i>	
L	= Low Profile Actuator
LT	= Low Profile Actuator & Tape sealed

DSP-42-XX 01 Z (THT Type)

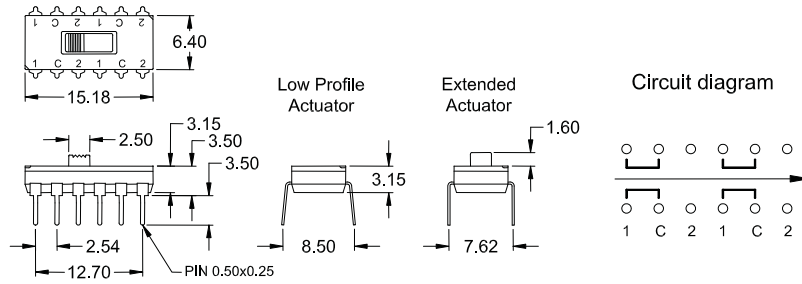
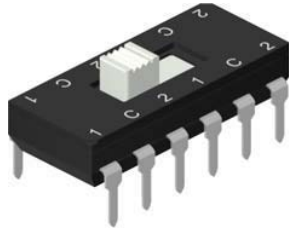

DSP-42-XX 02 Z (SMT Type)

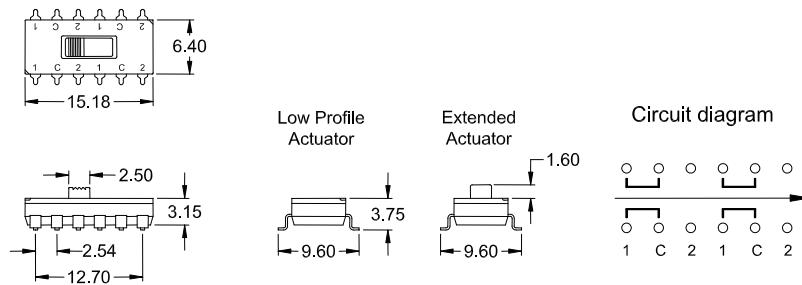
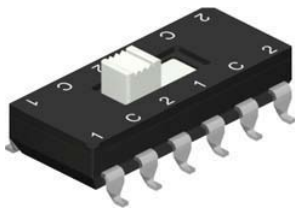

PCB Layout

DSP-42-XX 01 Z (THT Type)

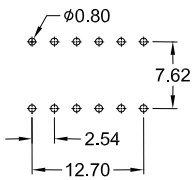

DSP-42-XX 02 Z (SMT Type)

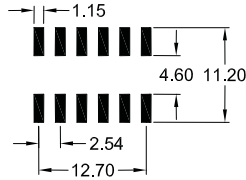

Option

Tape sealed

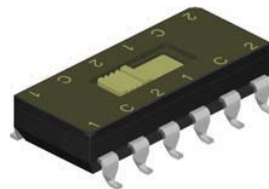

Application

Ideal as Function and Band Selector Switch in Radio-Cassette, Recorder, Office Equipment, TV sets, VCR etc.

SPECIFICATIONS

Electrical data

Contact Rating	25 mA, 24 V DC
-switching	100 mA, 50 V DC
-non-Switching	
Contact Resistance	50 mΩ max.
-initial	100 mΩ max.
-after life test	1000 MΩ min. at 100 V DC
Insulation Resistance	500 V AC for 1 Minute
Withstanding Voltage	5 pF max.
Capacitance between adjacent switches	

Mechanical and Environmental data

Operating Temperature	-25°C to +70°C
Storage Temperature	-40°C to +85°C
Soldering Temperature	
-SMT reflow soldering	250°C +0/-5°C for 10 sec. max.
-THT wave soldering	250°C +0/-5°C for 10 sec. max.
Operating Force	100 gf min / 1000 gf max.
Mechanical Life	2000 operations
Vibration	10 Hz – 50 Hz – 10 Hz for 6 hours

FEATURES

- Same size as an IC, 7.62mm (.300"), can be assembled by any automatic IC Inserter
- Top tape sealed to withstand solder vapors and board washing
- All plastics used are UL 94V-0 grade fire retardant
- Gold plated contacts to ensure low contact resistance and tin plated terminal to prevent contamination during soldering

How to order

DSP – 42 – XX xx Z

Contact Form
42 = 4PDT

Device Type, Actuator, DIP Space & Packing	
L 01	= THT Type; Low Profile Actuator DIP space 8.50mm; Tube packing
LT 01	= THT Type; Low Profile Actuator DIP space 8.50mm; Top sealed; Tube packing
E 01	= THT Type; Extended Actuator DIP space 7.62mm; Tube packing
L 02	= SMT Type; Low Profile Actuator; Tube packing
LT 02	= SMT Type; Low Profile Actuator; Top sealed; Tube packing
LC 02	= SMT Type; Low Profile Actuator; Reel packing
LD 02	= SMT Type; Low Profile Actuator; Top sealed; Reel packing
E 02	= SMT Type; Extended Actuator; Tube packing
EC 02	= SMT Type; Extended Actuator; Reel packing



SPST Contact Form

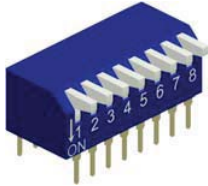

Position	2	3	4	5	6
Dim. "A"	6.70	9.20	11.70	14.20	16.70
Position	7	8	9	10	12
Dim. "A"	19.20	21.70	24.20	26.70	31.80

Unit: mm

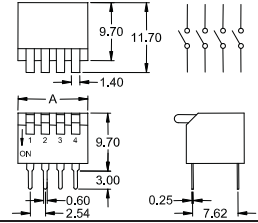

DPST Contact Form

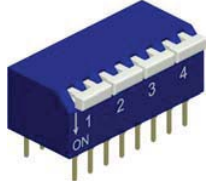

Position	1	2	3	4	5	6
Dim. "A"	6.70	11.70	16.70	21.70	26.70	31.80

Unit: mm

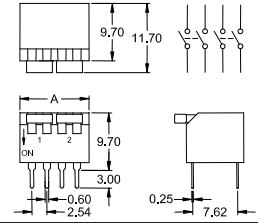

SPDT Contact Form

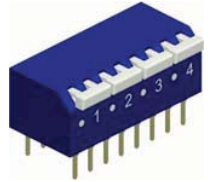

Position	1	2	3	4	5	6
Dim. "A"	6.70	11.70	16.70	21.70	26.70	31.80

Unit: mm

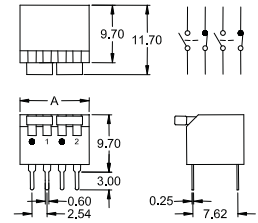

Construction

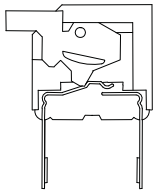

PCB Hole Layout

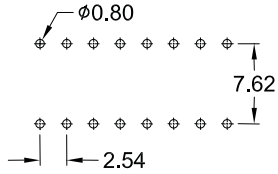

Options

- 1. Top side "OFF" and "ON" available
- 2. Black body color available
- 3. Tape sealed

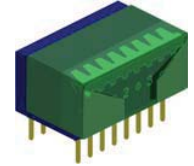
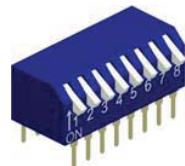

SPECIFICATIONS

Electrical data

Contact Rating	25 mA, 24 V DC
-switching	100 mA, 50 V DC
Contact Resistance	
-initial	50 mΩ max.
-after life test	100 mΩ max.
Insulation Resistance	1000 MΩ min. at 100 V DC
Withstanding Voltage	500 V AC for 1 Minute
Capacitance between adjacent switches	5 pF max.

Mechanical and Environmental data

Operating temperature	-25°C to +70°C
Storage temperature	-40°C to +85°C
Operating force	800 gf max.
Mechanical life	1000 operations
Vibration	10 Hz – 50 Hz – 10 Hz for 6 hours

FEATURES

- Edge actuated (piano type) easy setting on closely racked PCB
- Tactile response is performed directly by larger contact pressure to ensure very stable contact
- All plastic are UL 94V-0 grade fire retardant
- Bottom epoxy sealed standard to ensure free of flux immersion during wave soldering
- Contact wiping on make and break
- Gold plated (*gold/gold*) or Tin plated contact to ensure low contact resistance and long operation life
- Ideal for Data Processing, Telecommunication, Remote Control and Burglar Alarm System use, where manual programming is required

How to order

DPX - x xx - XX Z

<p>Series</p> <p>DPG = Gold plated Contacts</p> <p>DPS = Tin plated Contacts</p>	<p>Contact Form</p> <p>1 = SPST</p> <p>2 = DPST</p> <p>3 = SPDT</p>	<p>Nbr of positions</p> <p>see under position/dimension box above</p> <p>Example: 1 Position = 01 2 Position = 02 etc.</p>	<p>"ON/OFF" Position and Sealing</p> <p>A = Top side OFF</p> <p>AT = Top side OFF & Tape sealed</p> <p>B = Top side ON</p> <p>BT = Top side ON & Tape sealed</p>
---	---	---	---

DPDT Contact Form

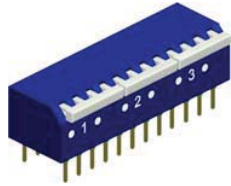

Position	1	2	3
Dim. "A"	11.70	21.70	31.80

Unit: mm

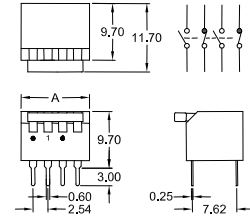

3PST Contact Form

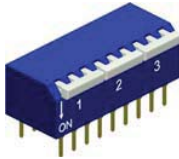

Position	1	2	3	4
Dim. "A"	9.20	16.70	24.20	31.80

Unit: mm

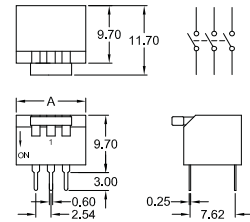

4PST Contact Form

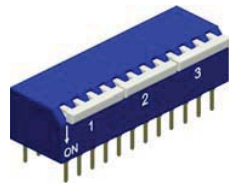

Position	1	2	3
Dim. "A"	11.70	21.70	31.80

Unit: mm

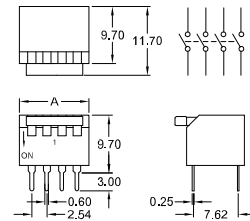

Construction

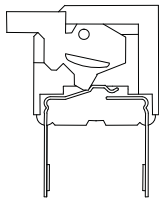

PCB Hole Layout

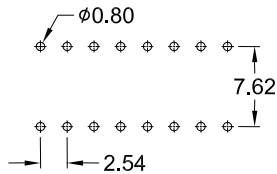

Options

- 1. Black body color available
- 2. Tape sealed

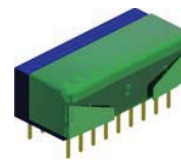

Application

Ideal for Data Processing, Telecommunication, Remote Control and Burglar Alarm System use, where manual programming is required.

SPECIFICATIONS

Electrical data

Contact Rating	
-switching	25 mA, 24 V DC
-non-Switching	100 mA, 50 V DC
Contact Resistance	
-initial	50 mΩ max.
-after life test	100 mΩ max.
Insulation Resistance	1000 MΩ min. at 100 V DC
Withstanding Voltage	500 V AC for 1 Minute
Capacitance between adjacent switches	5 pF max.

Mechanical and Environmental data

Operating temperature	- 25°C to +70°C
Storage temperature	- 40°C to +85°C
Operating force	800 gf max.
Mechanical life	1000 operations
Vibration	10 Hz – 50 Hz – 10 Hz for 6 hours

FEATURES

- Edge actuated (piano type) easy setting on closely racked PCB
- Tactile response is performed directly by larger contact pressure to ensure very stable contact
- Bottom epoxy sealed standard to ensure free of flux immersion during wave soldering
- Contact wiping on make and break
- All plastics used are UL 94V-0 grade fire retardant
- Gold plated (*gold/gold*) or Tin plated contact to ensure low contact resistance and long operation life

How to order

DPX – x xx – XX Z

Series	Contact Form	Nbr of positions	Actuator and Sealing
DPG = Gold plated Contacts	4 = 3PST	see under position/dimension box above	A = Top side OFF
DPS = Tin plated Contacts	5 = 4PST	Example: 1 Position = 01 2 Position = 02 etc.	AT = Top side OFF & Tape sealed
	6 = DPDT		B = Top side ON
			BT = Top side ON & Tape sealed

DPH Series

PIANO LOW PROFILE "THT" TYPE



Technical drawings showing dimensions: 8.60, 1.30, 2.54, 3.50, 5.65, 7.62, 0.80, 5.00, PIN 0.50x0.25, and dimension A.

Position	2	4	6	8	10
Dim. "A"	6.50	11.60	16.70	21.70	26.70

Unit: mm

<p>Construction</p>	<p>PCB Hole Layout</p>	<p>Option</p> <p>Tape sealed</p>
----------------------------	-------------------------------	---

SPECIFICATIONS	
<p>Electrical data</p> <p>Contact Rating -switching 25 mA, 24 V DC -non-Switching 100 mA, 50 V DC</p> <p>Contact Resistance -initial 50 mΩ max. -after life test 100 mΩ max.</p> <p>Insulation Resistance 1000 MΩ min. at 100 V DC</p> <p>Withstanding Voltage 500 V AC for 1 Minute</p> <p>Capacitance between adjacent switches 5 pF max.</p>	<p>Mechanical and Environmental data</p> <p>Operating Temperature -25°C to +70°C</p> <p>Storage Temperature -40°C to +85°C</p> <p>Operating Force 800 gf max.</p> <p>Mechanical Life 1000 operations</p> <p>Vibration 10 Hz – 50 Hz – 10 Hz for 6 hours</p>

- | FEATURES | |
|---|--|
| <ul style="list-style-type: none"> ● Edge actuated (piano type) easy setting on closely racked PCB ● Tactile response is performed directly by larger contact pressure to ensure very stable contact ● All plastic are UL 94V-0 grade fire retardant | <ul style="list-style-type: none"> ● Twin contact design to ensure stable contact ● Contact wiping on make and break ● Gold plated contacts to ensure low contact resistance, and tin plated terminal to prevent contamination during soldering (<i>gold/tin</i>) |

How to order

DPH – 1 xx – XX Z

Nbr of positions

see under position/dimension box above

Example:
 2 Position = 02
 4 Position = 04
 etc.

Actuator and "ON/OFF" Position

LA = Low Profile Actuator
EA = Extended Actuator
LAT = Low Profile Actuator & Tape sealed

the DPH Series is basically "Top Side OFF"

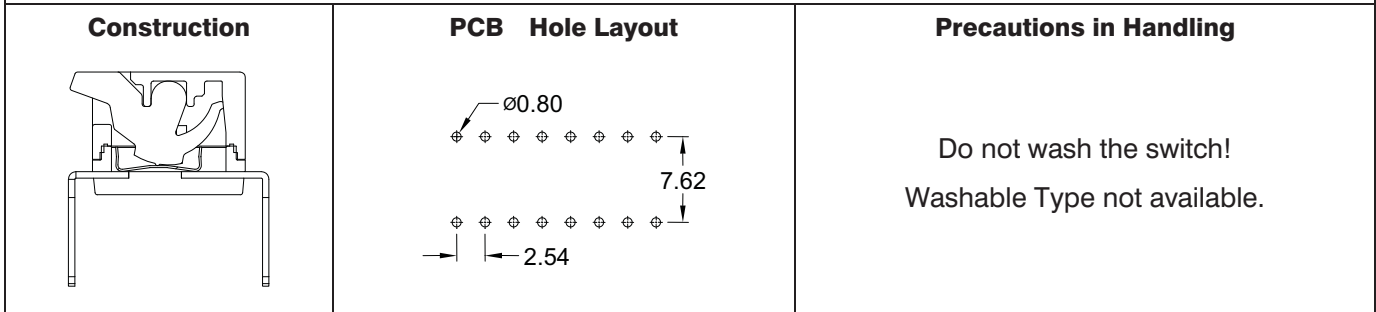
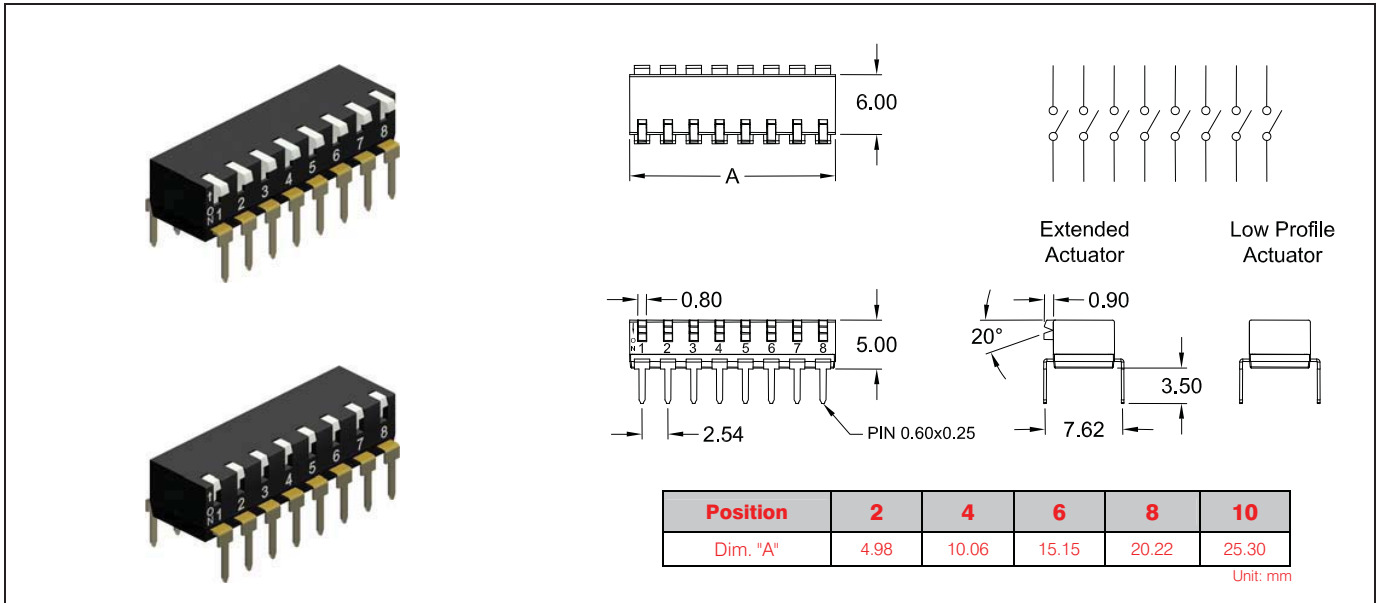

SPECIFICATIONS	
<p>Electrical data</p> <p>Contact Rating</p> <ul style="list-style-type: none"> -switching 25 mA, 24 V DC -non-switching 100 mA, 50 V DC <p>Contact Resistance</p> <ul style="list-style-type: none"> -initial 100 mΩ max. -after life test 200 mΩ max. <p>Insulation Resistance 100 MΩ min. at 500 V DC</p> <p>Withstanding Voltage 500 V AC for 1 Minute</p> <p>Capacitance between adjacent switches 5 pF max..</p>	<p>Mechanical and Environmental data</p> <p>Operating Temperature -20°C to +85°C</p> <p>Storage Temperature -40°C to +85°C</p> <p>Operating Force 800 gf max.</p> <p>Mechanical Life 2000 operations</p> <p>Vibration 10 Hz – 50 Hz – 10 Hz for 6 hours</p>

- | FEATURES | |
|--|---|
| <ul style="list-style-type: none"> End stackable for standard 2.54mm (.100") integrated circuit pitch Twin contact design to ensure stable contact | <ul style="list-style-type: none"> All plastics used are UL 94V-0 grade fire retardant Gold plated contacts, contact & solder area (<i>gold/gold</i>), to ensure low contact resistance |

How to order

DPI – 1 xx – XX 1 0 Z

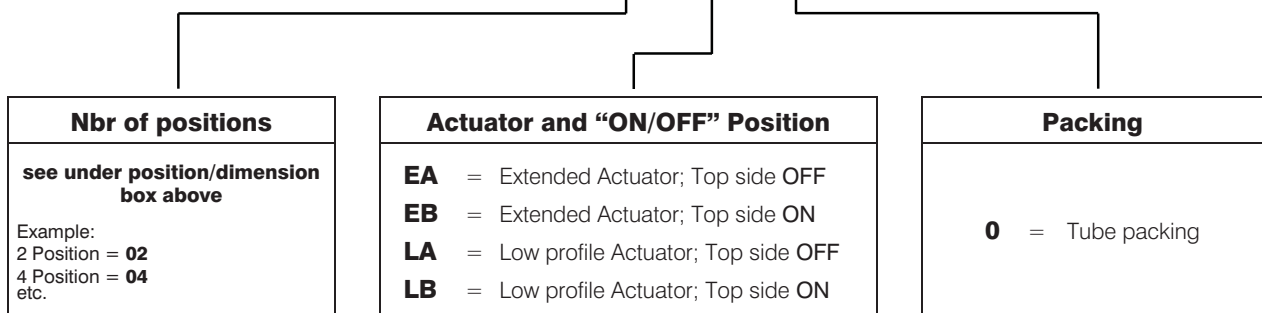

DPA Series

PIANO LOW PROFILE "SMT" TYPE



Position	2	4	6	8	10
Dim. "A"	6.50	11.60	16.70	21.70	26.70

Unit: mm

Construction	PCB SMT Layout	Option
		Tape sealed

SPECIFICATIONS

Electrical data		Mechanical and Environmental data	
Contact Rating		Operating Temperature	-25°C to +70°C
-switching	25 mA, 24 V DC	Storage Temperature	-40°C to +85°C
-non-Switching	100 mA, 50 V DC	Soldering Temperature	
Contact Resistance		-SMT reflow soldering	250°C +0/-5°C for 10 sec.
-initial	50 mΩ max.	Operating Force	800 gf max.
-after life test	100 mΩ max.	Mechanical Life	1000 operations
Insulation Resistance	1000 MΩ min. at 100 V DC	Vibration	10 Hz – 50 Hz – 10 Hz for 6 hours
Withstanding Voltage	500 V AC for 1 Minute		
Capacitance between adjacent switches	5 pF max.		

FEATURES

<ul style="list-style-type: none"> ● Edge actuated (piano type) easy setting on closely racked PCB ● Tactile response is performed directly by larger contact pressure to ensure very stable contact ● All plastic are UL 94V-0 grade fire retardant 	<ul style="list-style-type: none"> ● Twin contact design to ensure stable contact ● Contact wiping on make and break ● Gold plated contacts to ensure low contact resistance, and tin plated terminal to prevent contamination during soldering (<i>gold/tin</i>)
---	--

How to order
DPA – 1 xx – XX Xx Z

Nbr of positions	Actuator and "ON/OFF" Position	Packing and Sealing
<p style="text-align: center;">see under position/dimension box above</p> <p>Example: 2 Position = 02 4 Position = 04 etc.</p>	<p>EA = Extended Actuator; Top side OFF</p> <hr/> <p>LA = Low Profile Actuator; Top side OFF</p>	<p>00 = Tube packing 10 = Reel packing</p> <hr/> <p>00 = Tube packing 10 = Reel packing T0 = Tube packing & Tape sealed T1 = Reel packing & Tape sealed</p>

Position	2	4	6	8	10
Dim. "A"	4.98	10.06	15.15	20.22	25.30

Unit: mm

Construction	PCB SMT Layout	Precautions in Handling
		<p>Do not wash the switch!</p> <p>Washable Type not available.</p>

SPECIFICATIONS

Electrical data		Mechanical and Environmental data	
Contact Rating		Operating Temperature	-20°C to +85°C
-switching	25 mA, 24 V DC	Storage Temperature	-40°C to +85°C
-non-switching	100 mA, 50 V DC	Soldering Temperature	
Contact Resistance		-SMT reflow soldering	250°C +0/-5°C for 10 sec.
-initial	100 mΩ max.	Operating Force	800 gf max.
-after life test	200 mΩ max.	Mechanical Life	2000 operations
Insulation Resistance	100 MΩ min. at 500 V DC	Vibration	10 Hz – 50 Hz – 10 Hz for 6 hours
Withstanding Voltage	500 V AC for 1 Minute		
Capacitance between adjacent switches	5 pF max..		

FEATURES

<ul style="list-style-type: none"> End stackable for standard 2.54mm (.100") integrated circuit pitch Twin contact design to ensure stable contact 	<ul style="list-style-type: none"> All plastics used are UL 94V-0 grade fire retardant Gold plated contacts, contact & solder area (<i>gold/gold</i>), to ensure low contact resistance
--	---

How to order

DPM – 1 xx – XX 1 xx Z

Nbr of positions	Actuator and "ON/OFF" Position	Packing
<p>see under position/dimension box above</p> <p>Example: 2 Position = 02 4 Position = 04 etc.</p>	<p>EA = Extended Actuator; Top side OFF</p> <p>EB = Extended Actuator; Top side ON</p> <hr/> <p>LA = Low profile Actuator; Top side OFF</p> <p>LB = Low profile Actuator; Top side ON</p>	<p>10 = Tube packing</p> <p>11 = Reel packing</p> <hr/> <p>10 = Tube packing</p> <p>11 = Reel packing</p> <p>T0 = Tube packing & Tape sealed</p> <p>T1 = Reel packing & Tape sealed</p>

Other products from E-tec



Please contact your closest sales office for further information.

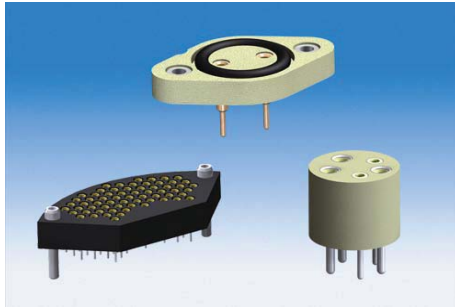

Customized Products

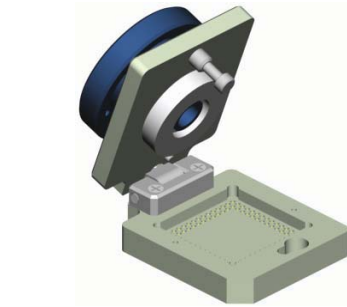

Test Sockets & Adapters

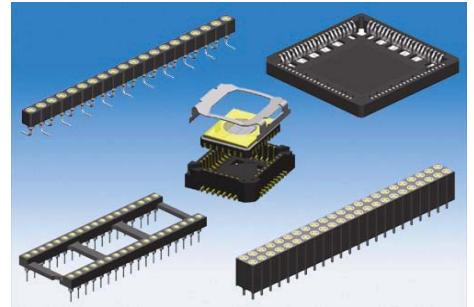

IC - Sockets

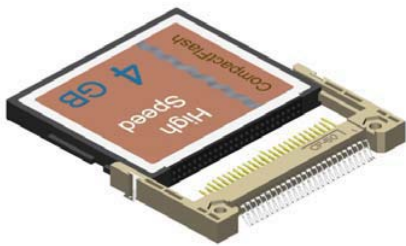

Compact Flash Connectors



USB & IEEE 1394 Connectors

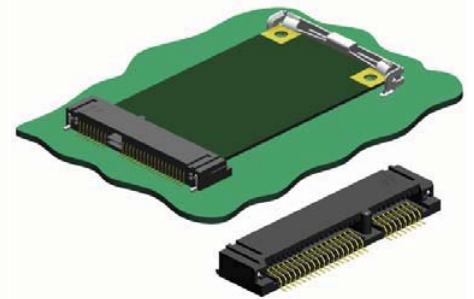

Mini PCI Express Connectors

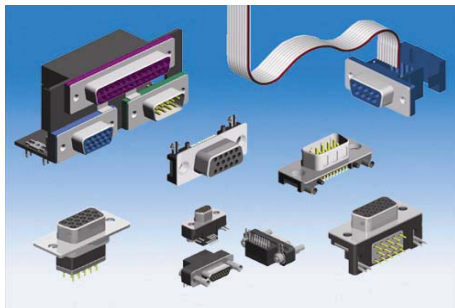

D-Sub Connectors

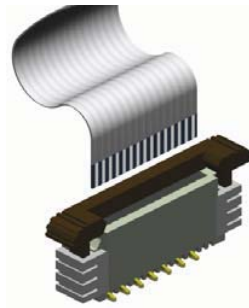

Flex Cable Connectors



HDMI Connectors

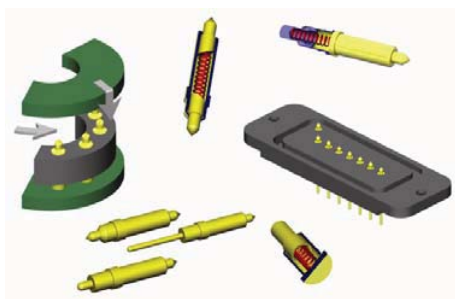

Probe Pin & Probe Pin Connectors

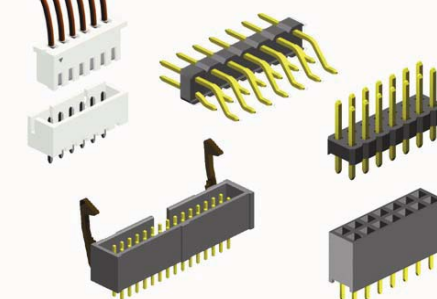

PCB Connectors

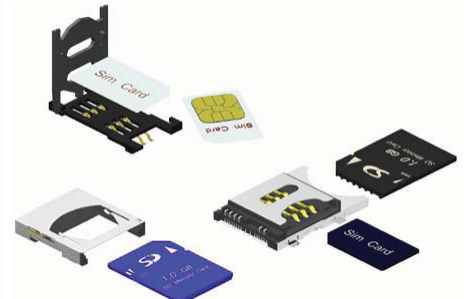

Multi Media Card Connectors

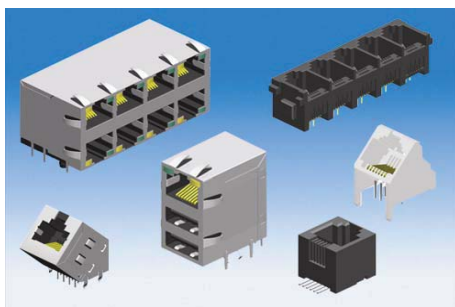

Modular Plugs & Jacks

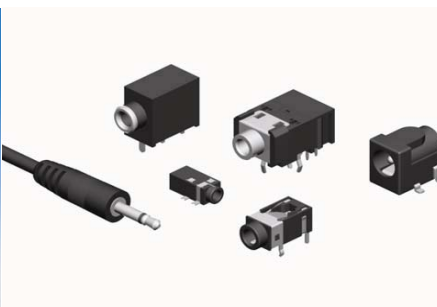

Phono - & DC - Power Connectors



RF - Connectors

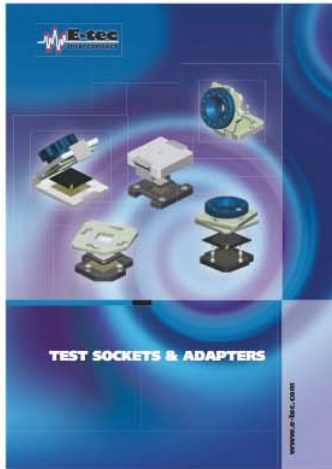
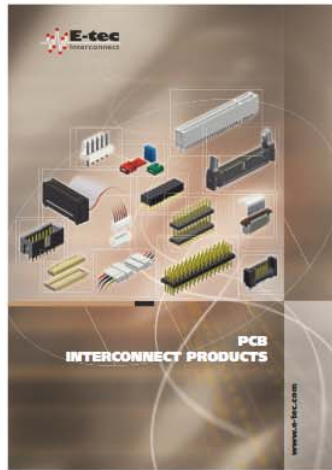
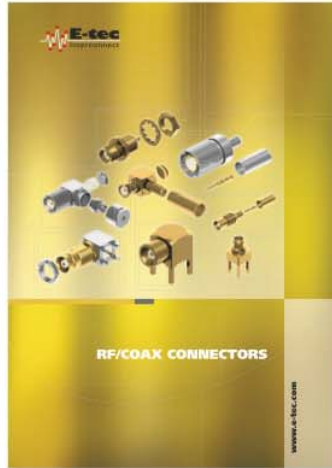

International Sales Headquarters

Switzerland E-tec Interconnect Ltd.
 Schweiz Chemin du Grand-Pré 9A
 Suisse CH-1510 Moudon
 Phone: +41/21/781 08 10
 Fax: +41/21/781 08 11
 e-mail: info@e-tec.com
 www.e-tec.com

Related Sales Headquarters

Deutschland EMC electro mechanical
 Germany components GmbH
 Allemagne PO Box/Postfach 11 60
 D-65501 Idstein
 Phone: +49/61 26/9395-0
 Fax: +49/61 26/9395-72
 e-mail: info@emc-connectors.com
 www.emc-connectors.com

France Silfox SA
 Frankreich PA des Petits Carreaux
 2 bis avenue des Coquelicots
 F-94385 BONNEUIL
 SUR MARNE CEDEX
 Phone: +33/1/4956 04 68
 Fax: +33/1/4956 02 87
 e-mail: info@silfox.fr
 www.silfox.fr

England E-tec Interconnect (UK) Ltd.
 Angleterre Units A5 & A6 Decimus Park
 Kingstanding Way
 Tunbridge Wells
 Kent TN2 3GP
 Phone: +44/1892/530260
 Fax: +44/1892/515560
 e-mail: info@e-tec.co.uk
 www.e-tec.co.uk

Factories

Switzerland E-tec AG
 Schweiz Friedhofstrasse 1
 Suisse CH-2543 Lengnau b. Biel
 Phone: +41/32/654 15 50
 Fax: +41/32/652 26 93
 e-mail: info@etecag.ch
 www.etecag.ch

Taiwan E-tec Interconnect Asia Ltd.
 10F-2, No. 379, Jhongshan Road
 Sanchong Dist. New Taipei City
 Taiwan R.O.C.
 Phone: +886/2/2 999-2726
 Fax: +886/2/2 999-5255
 e-mail: info@e-tec-asia.com.tw
 www.e-tec-asia.com.tw

YOUR AUTHORISED DISTRIBUTOR
 IHR VERTRAGS-DISTRIBUTOR
 VOTRE DISTRIBUTEUR OFFICIEL