

TOP VIEW

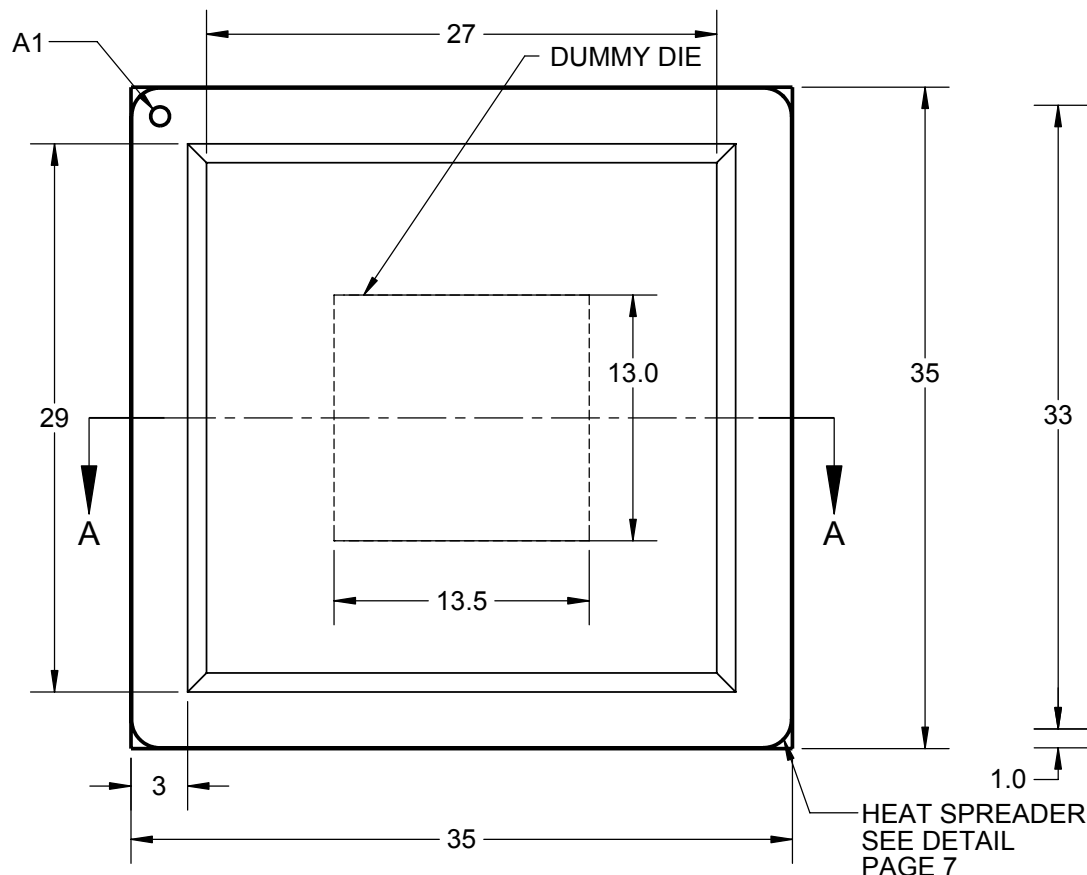

BALL VIEW

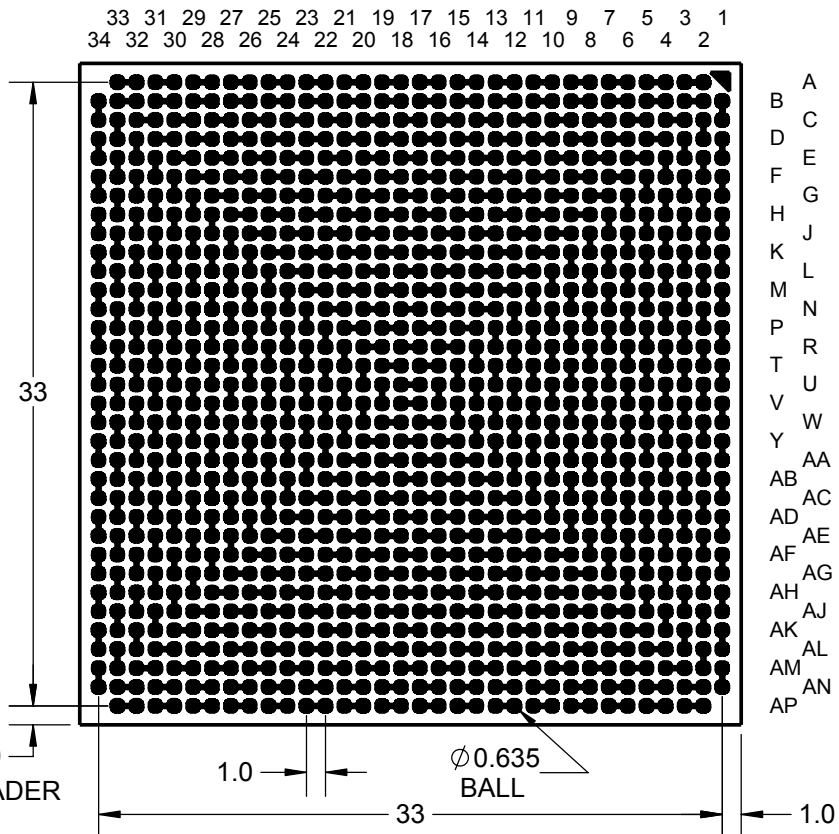

Notes: (Unless Otherwise Specified).

- 1) ALL DIMENSIONS ARE IN MM.
- 2) SOLDER BALL ALLOY: SEE PART NUMBER TABLE.
- 3) BALL DIAMETER (BEFORE REFLOW) 0.635mm [25 mil].
- 4) SOLDER MASK DEFINED PAD OPENING: 0.508mm [20mil].
- 5) PAD Cu DIAMETER: 0.635mm [25 mil].
- 6) SUBSTRATE MATERIAL: FR4 (OPTIONAL BT).
- 7) DUMMY DIE: Si (SILICON).
- 8) DAISY CHAIN PATTERN (SEE PAGE 2).
- 9) MSL-3 RECOMMENDED BAKING 24 HOURS @ 125°C TO REMOVE MOISTURE PRIOR TO SOLDERING TO PC BOARD.

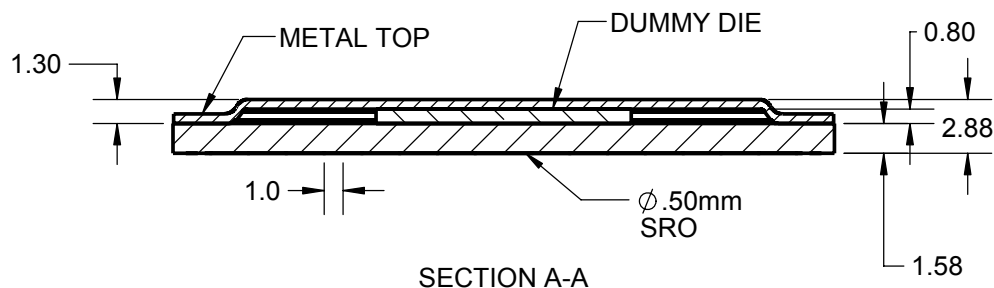

PART NUMBER TABLE

PART NUMBER	BALL METAL	BALL ALLOY	RoHS	Si DIE
LGA1152T1.0G20-DC344D	Cu 35 um (0.7mil) Ni - 3.8um (150 micro-inch) Au - 0.127um (5 micro-inch)	NONE	YES	YES

APPROVALS	DATE				
DRAWN T.Au	10/4/2016				
ENG M. Hart	10/4/2016	TITLE LGA1152T1.0G20-DC344D DAISY CHAIN DUMMY			
MFG		SCALE 2.5:1	SIZE A	DRAWING NO. 513448	REV A
QA		DO NOT SCALE DRAWING			SHEET 1 OF 17
CUST					
REVISED					

BALL VIEW

33 31 29 27 25 23 21 19 17 15 13 11 9 7 5 3 1
34 32 30 28 26 24 22 20 18 16 14 12 10 8 6 4 2

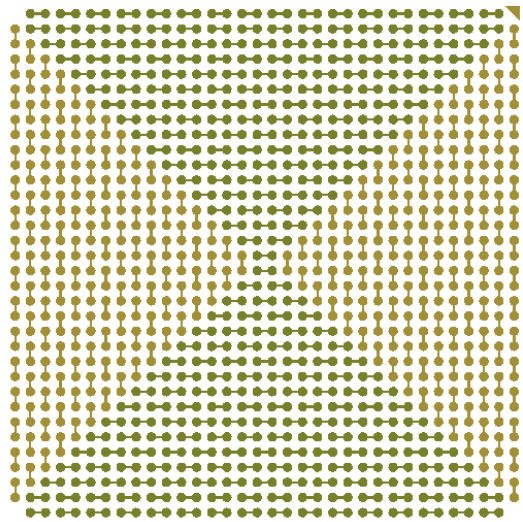

A
B
C
D
E
F
G
H
J
K
L
M
N
P
R
T
U
V
W
Y
AA
AB
AC
AD
AE
AF
AG
AH
AJ
AK
AL
AM
AN
AP

2 4 6 8 10 12 14 16 18 20 22 24 26 28 30 32 34
1 3 5 7 9 11 13 15 17 19 21 23 25 27 29 31 33

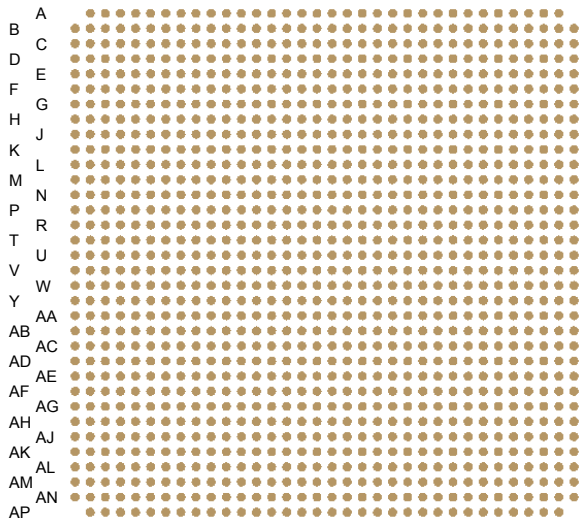

TEST VEHICLE BOARD
UNDER DEVELOPMENT

BOTTOM SIDE (TOP X-RAY VIEW)

2 4 6 8 10 12 14 16 18 20 22 24 26 28 30 32 34
1 3 5 7 9 11 13 15 17 19 21 23 25 27 29 31 33

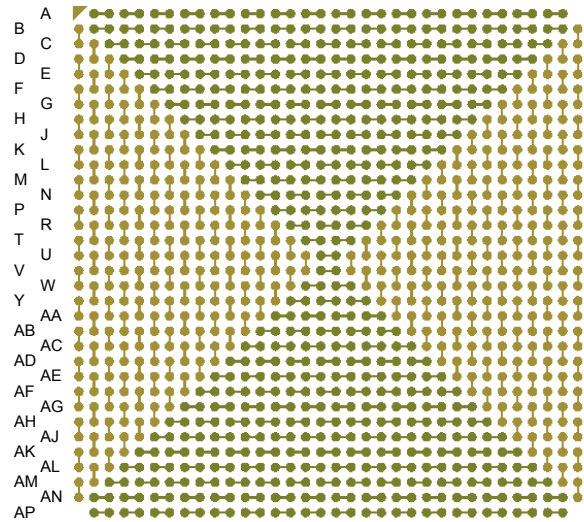

A
B
C
D
E
F
G
H
J
K
L
M
N
P
R
T
U
V
W
Y
AA
AB
AC
AD
AE
AF
AG
AH
AJ
AK
AL
AM
AN
AP

2 4 6 8 10 12 14 16 18 20 22 24 26 28 30 32 34
1 3 5 7 9 11 13 15 17 19 21 23 25 27 29 31 33

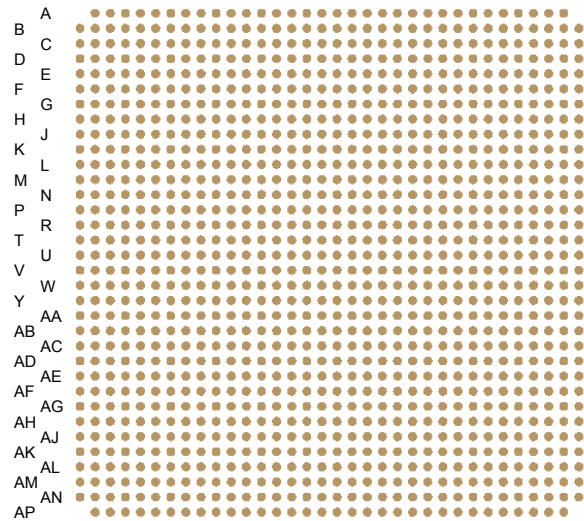

TEST VEHICLE BOARD
UNDER DEVELOPMENT

Notes: (Unless Otherwise Specified).

- 1) PCB BOARD DIMENSIONS ARE PRESENTED ONLY AS A GUIDELINE
DESIGNERS SHOULD USE THEIR OWN KNOWLEDGE WHEN DESIGNING THE PCB.
- 2) PCB Cu BALL PAD DIAMETER: 0.450 [25 mil].
- 3) PCB DAISY CHAIN TRACING LINE WIDTH: 0.152 [6mil].
- 4) SMD (SOLDERMASK DEFINED) PAD OPENING: 0.508mm [20mil].

TopLine[®]

TITLE LGA1152T1.0G20-DC344D
DAISY CHAIN DUMMY

SCALE 2:1	SIZE A	DRAWING NO. 513448	REV A
--------------	-----------	-----------------------	----------

DO NOT SCALE DRAWING

SHEET 2 OF 17

BALL VIEW

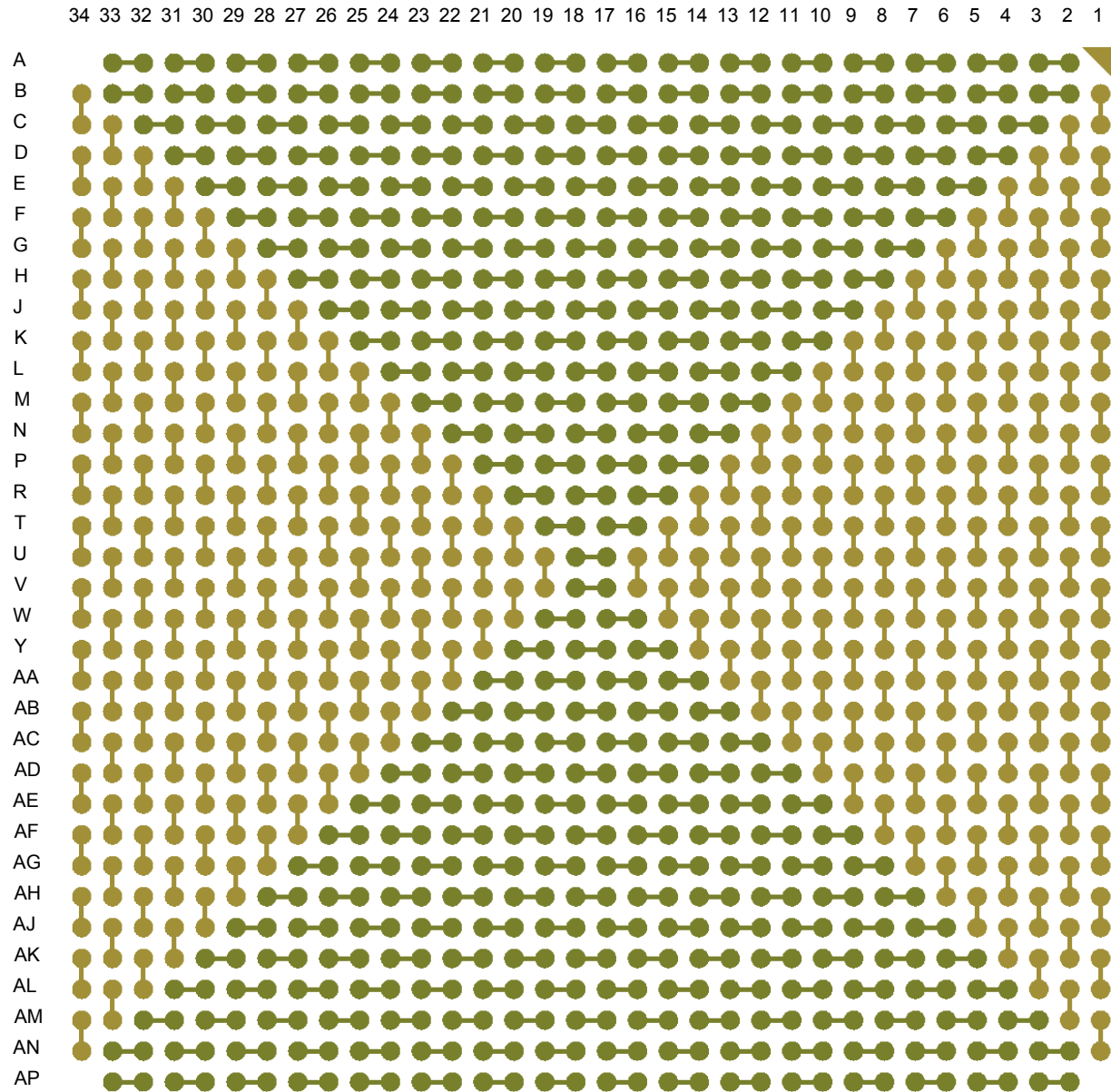

TopLine[®]			
TITLE		LGA1152T1.0G20-DC344D DAISY CHAIN DUMMY	
SCALE	SIZE	DRAWING NO.	REV
4.5:1	A	513448	A
DO NOT SCALE DRAWING			SHEET 3 OF 17

BOTTOM SIDE (TOP X-RAY VIEW)

1 2 3 4 5 6 7 8 9 10 11 12 13 14 15 16 17 18 19 20 21 22 23 24 25 26 27 28 29 30 31 32 33 34

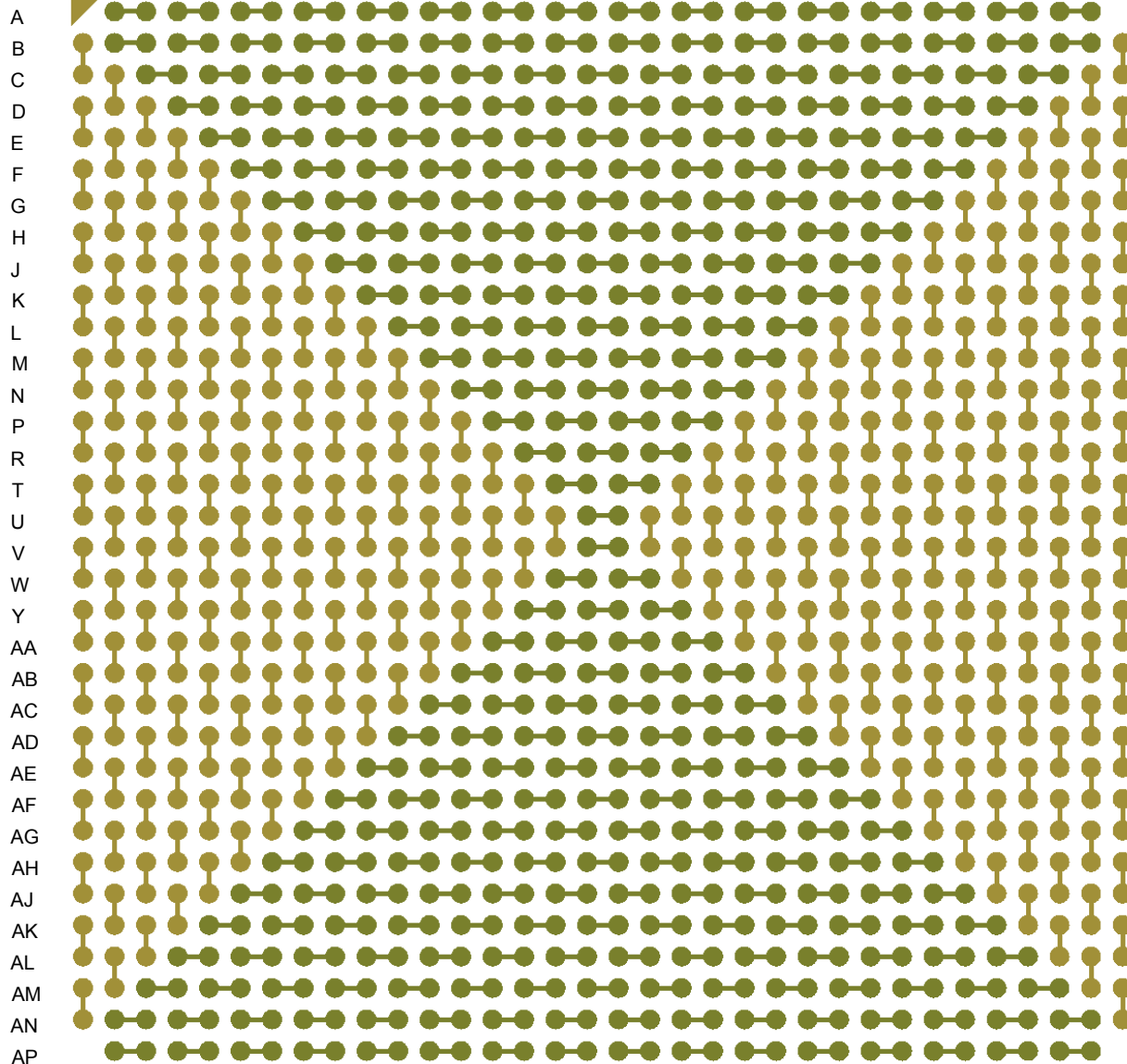

TITLE			
LGA1152T1.0G20-DC344D DAISY CHAIN DUMMY			
SCALE	SIZE	DRAWING NO.	REV
4.5:1	A	513448	A
DO NOT SCALE DRAWING			SHEET 4 OF 17

TEST VEHICLE BOARD

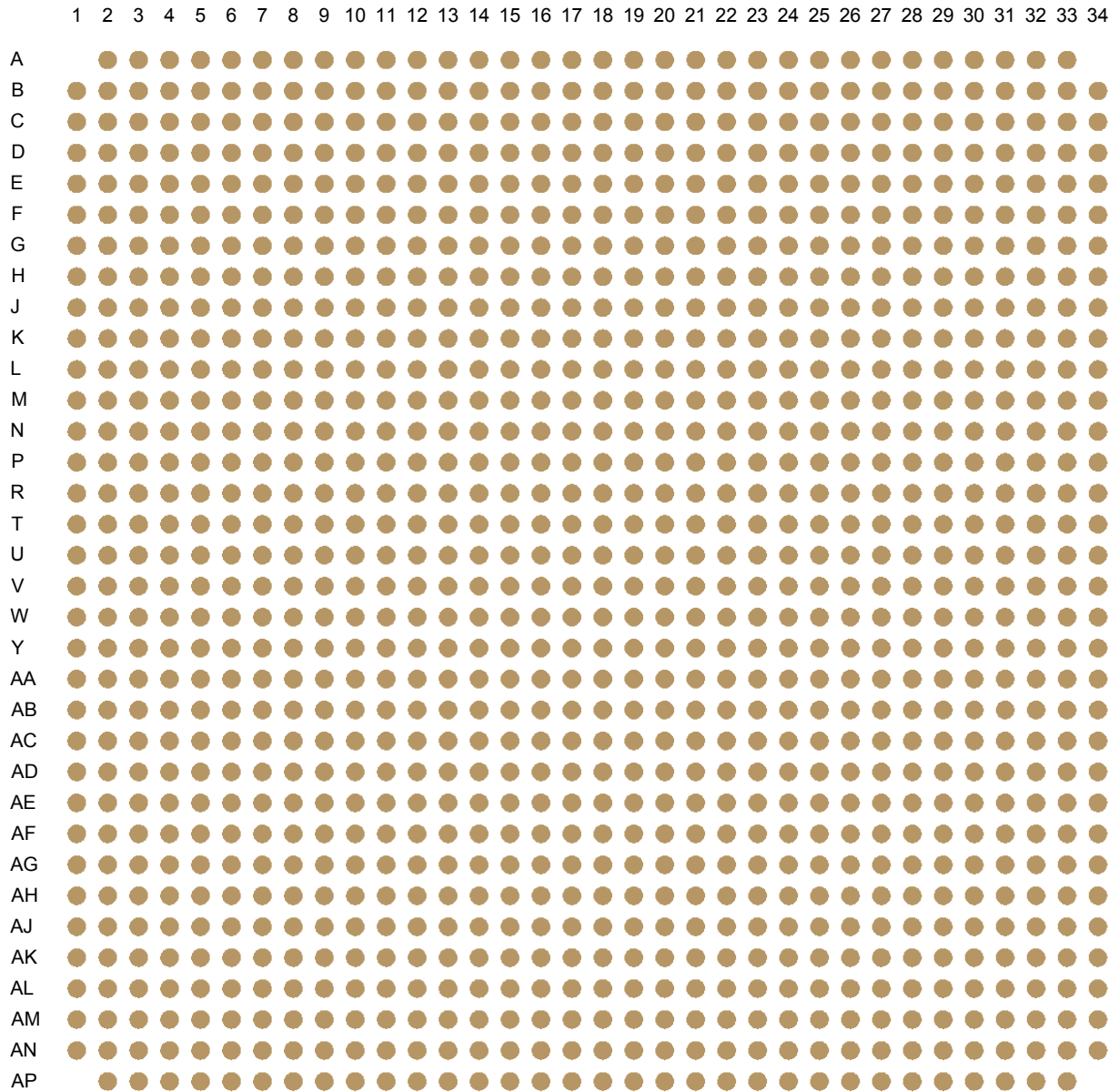

**UNDER
DEVELOPMENT**

TopLine®			
TITLE LGA1152T1.0G20-DC344D DAISY CHAIN DUMMY			
SCALE 4.5:1	SIZE A	DRAWING NO. 513448	REV A
DO NOT SCALE DRAWING			SHEET 5 OF 17

AFTER MOUNTING TO TEST BOARD

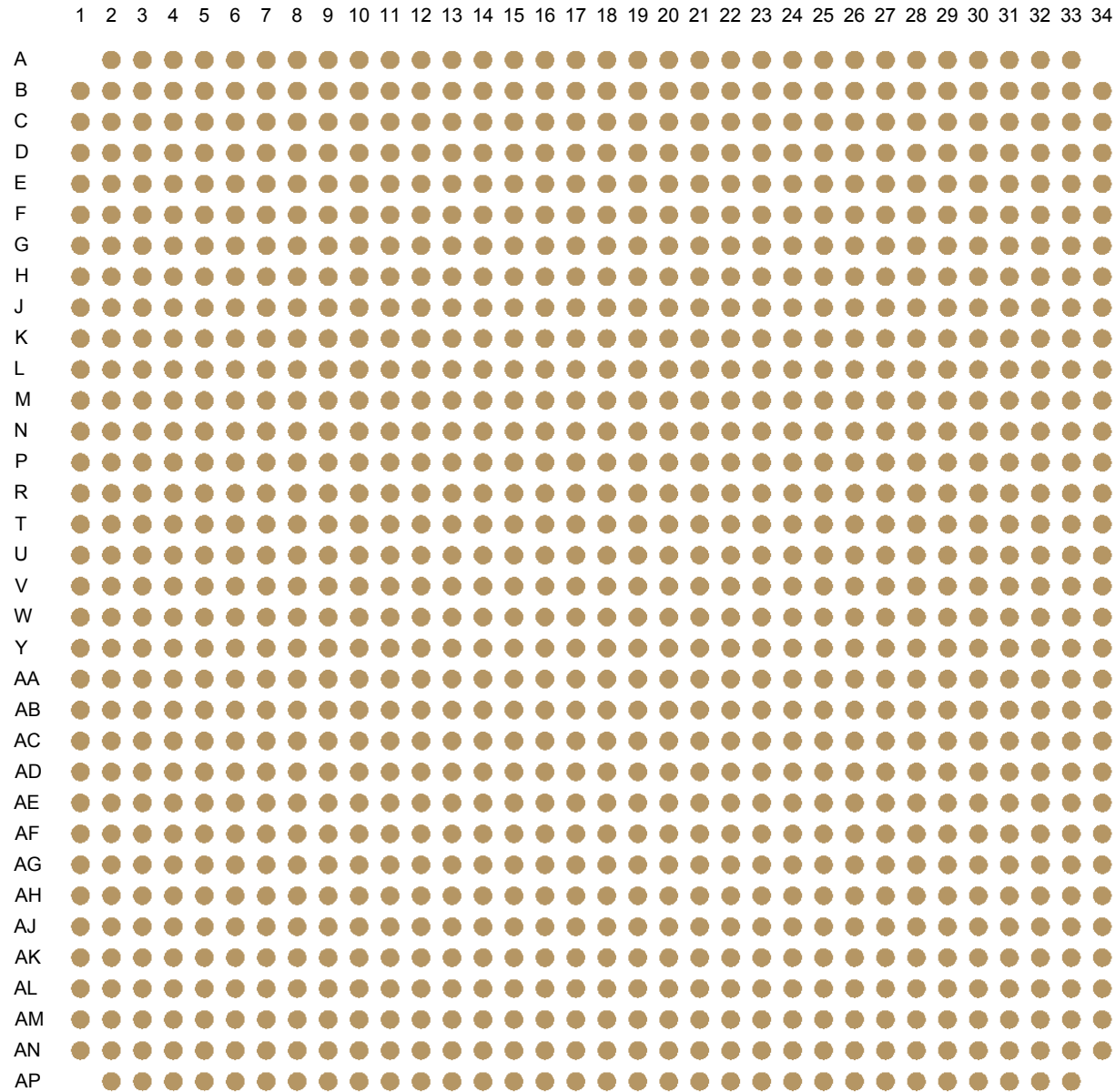

**UNDER
DEVELOPMENT**

TopLine[®]			
TITLE		LGA1152T1.0G20-DC344D DAISY CHAIN DUMMY	
SCALE	SIZE	DRAWING NO.	REV
4.5:1	A	513448	A
DO NOT SCALE DRAWING			SHEET 6 OF 17

HEAT SPREADER

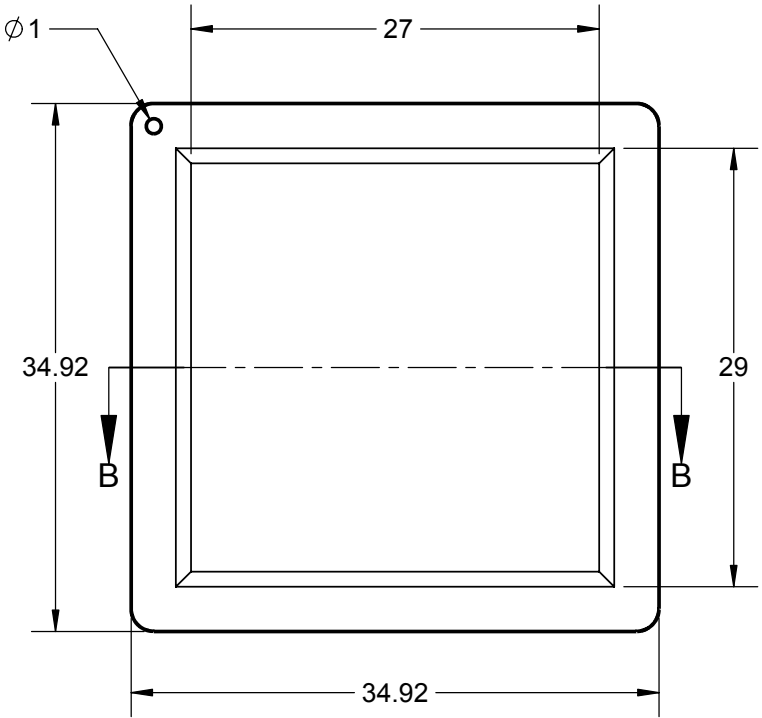

TOP

MODEL



CAVITY

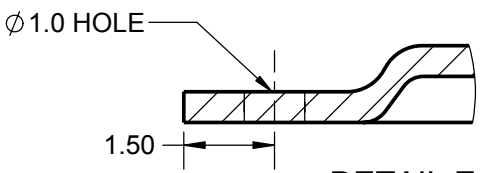

DETAIL E
SCALE 8 : 1

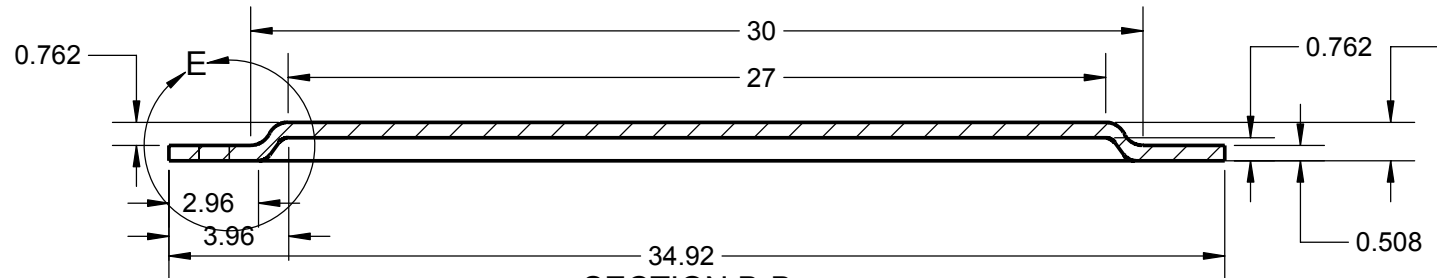

SECTION B-B
SCALE 4 : 1

1.27* * ADD 0.13MM SEALANT

TopLine®			
TITLE LGA1152T1.0G20-DC344D DAISY CHAIN DUMMY			
SCALE 2:1	SIZE A	DRAWING NO. 513448	REV A
DO NOT SCALE DRAWING			SHEET 7 OF 17

MODEL

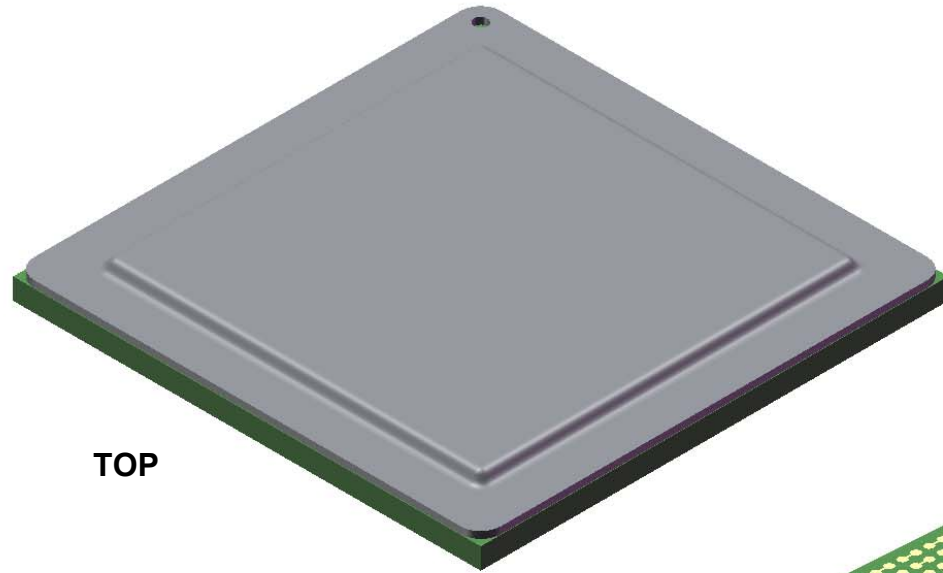

TOP

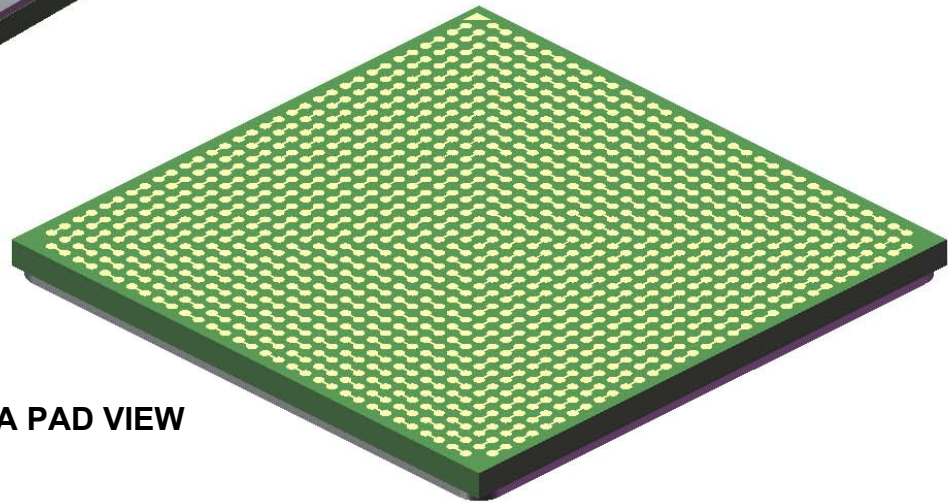

LGA PAD VIEW

TopLine[®]

TITLE LGA1152T1.0G20-DC344D
DAISY CHAIN DUMMY

SCALE 2.5:1	SIZE A	DRAWING NO. 513448	REV A
----------------	-----------	-----------------------	----------

DO NOT SCALE DRAWING

SHEET 8 OF 17

DAISY CHAIN NET LIST

DC PAIR	
B1	C1
D1	E1
F1	G1
H1	J1
K1	L1
M1	N1
P1	R1
T1	U1
V1	W1
Y1	AA1
AB1	AC1
AD1	AE1
AF1	AG1
AH1	AJ1
AK1	AL1
AM1	AN1
C2	D2
E2	F2
G2	H2
J2	K2
L2	M2
N2	P2
R2	T2
U2	V2
W2	Y2
AA2	AB2
AC2	AD2
AE2	AF2
AG2	AH2
AJ2	AK2
AL2	AM2
A2	A3
B2	B3
D3	E3
F3	G3
H3	J3
K3	L3
M3	N3
P3	R3
T3	U3
V3	W3
Y3	AA3
AB3	AC3
AD3	AE3

DC PAIR	
AK3	AL3
AN2	AN3
AP2	AP3
C3	C4
E4	F4
G4	H4
J4	K4
L4	M4
N4	P4
R4	T4
U4	V4
W4	Y4
AA4	AB4
AC4	AD4
AE4	AF4
AG4	AH4
AJ4	AK4
AM3	AM4
A4	A5
B4	B5
D4	D5
F5	G5
H5	J5
K5	L5
M5	N5
P5	R5
T5	U5
V5	W5
Y5	AA5
AB5	AC5
AD5	AE5
AF5	AG5
AH5	AJ5
AL4	AL5
AN4	AN5
AP4	AP5
C5	C6
E5	E6
G6	H6
J6	K6
L6	M6
N6	P6
R6	T6
U6	V6

DC PAIR	
W6	Y6
AA6	AB6
AC6	AD6
AE6	AF6
AG6	AH6
AK5	AK6
AM5	AM6
A6	A7
B6	B7
D6	D7
F6	F7
H7	J7
K7	L7
M7	N7
P7	R7
T7	U7
V7	W7
Y7	AA7
AB7	AC7
AD7	AE7
AF7	AG7
AJ6	AJ7
AL6	AL7
AN6	AN7
AP6	AP7
C7	C8
E7	E8
G7	G8
J8	K8
L8	M8
N8	P8
R8	T8
U8	V8
W8	Y8
AA8	AB8
AC8	AD8
AE8	AF8
AH7	AH8
AK7	AK8
AM7	AM8
A8	A9
B8	B9
D8	D9
F8	F9

DC PAIR	
H8	H9
K9	L9
M9	N9
P9	R9
T9	U9
V9	W9
Y9	AA9
AB9	AC9
AD9	AE9
AG8	AG9
AJ8	AJ9
AL8	AL9
AN8	AN9
AP8	AP9
C9	C10
E9	E10
G9	G10
J9	J10
L10	M10
N10	P10
R10	T10
U10	V10
W10	Y10
AA10	AB10
AC10	AD10
AF9	AF10
AH9	AH10
AK9	AK10
AM9	AM10
A10	A11
B10	B11
D10	D11
F10	F11
H10	H11
K10	K11
M11	N11
P11	R11
T11	U11
V11	W11
Y11	AA11
AB11	AC11
AE10	AE11
AG10	AG11
AJ10	AJ11

DC PAIR	
AL10	AL11
AN10	AN11
AP10	AP11
C11	C12
E11	E12
G11	G12
J11	J12
L11	L12
N12	P12
R12	T12
U12	V12
W12	Y12
AA12	AB12
AD11	AD12
AF11	AF12
AH11	AH12
AK11	AK12
AM11	AM12
A12	A13
B12	B13
D12	D13
F12	F13
H12	H13
K12	K13
M12	M13
P13	R13
T13	U13
V13	W13
Y13	AA13
AC12	AC13
AE12	AE13
AG12	AG13
AJ12	AJ13
AL12	AL13
AN12	AN13
AP12	AP13
C13	C14
E13	E14
G13	G14
J13	J14
L13	L14
N13	N14
R14	T14
U14	V14

DC PAIR	
W14	Y14
AB13	AB14
AD13	AD14
AF13	AF14
AH13	AH14
AK13	AK14
AM13	AM14
A14	A15
B14	B15
D14	D15
F14	F15
H14	H15
K14	K15
M14	M15
P14	P15
T15	U15
V15	W15
AA14	AA15
AC14	AC15
AE14	AE15
AG14	AG15
AJ14	AJ15
AL14	AL15
AN14	AN15
AP14	AP15
C15	C16
E15	E16
G15	G16
J15	J16
L15	L16
N15	N16
R15	R16
U16	V16
Y15	Y16
AB15	AB16
AD15	AD16
AF15	AF16
AH15	AH16
AK15	AK16
AM15	AM16
A16	A17
B16	B17
D16	D17
F16	F17

DC PAIR	
H16	H17
K16	K17
M16	M17
P16	P17
T16	T17
W16	W17
AA16	AA17
AC16	AC17
AE16	AE17
AG16	AG17
AJ16	AJ17
AL16	AL17
AN16	AN17
AP16	AP17
C17	C18
E17	E18
G17	G18
J17	J18
L17	L18
N17	N18
R17	R18
U17	U18
V17	V18
Y17	Y18
AB17	AB18
AD17	AD18
AF17	AF18
AH17	AH18
AK17	AK18
AM17	AM18
A18	A19
B18	B19
D18	D19
F18	F19
H18	H19

DC PAIR	
K18	K19
M18	M19
P18	P19
T18	T19
U19	V19
W18	W19
AA18	AA19
AC18	AC19
AE18	AE19
AG18	AG19
AJ18	AJ19
AL18	AL19
AN18	AN19
AP18	AP19
C19	C20
E19	E20
G19	G20
J19	J20
L19	L20
N19	N20
R19	R20
T20	U20
V20	W20
Y19	Y20
AB19	AB20
AD19	AD20
AF19	AF20
AH19	AH20
AK19	AK20
AM19	AM20
A20	A21
B20	B21
D20	D21
F20	F21
H20	H21

TopLine®			
TITLE LGA1152T1.0G20-DC344D DAISY CHAIN DUMMY			
SCALE	SIZE	DRAWING NO.	REV
2.5:1	A	513448	A
DO NOT SCALE DRAWING			SHEET 9 OF 17

DAISY CHAIN NET LIST

DC PAIR	
K20	K21
M20	M21
P20	P21
R21	T21
U21	V21
W21	Y21
AA20	AA21
AC20	AC21
AE20	AE21
AG20	AG21
AJ20	AJ21
AL20	AL21
AN20	AN21
AP20	AP21
C21	C22
E21	E22
G21	G22
J21	J22
L21	L22
N21	N22
P22	R22
T22	U22
V22	W22
Y22	AA22
AB21	AB22
AD21	AD22
AF21	AF22
AH21	AH22
AK21	AK22
AM21	AM22
A22	A23
B22	B23
D22	D23
F22	F23
H22	H23
K22	K23
M22	M23
N23	P23
R23	T23
U23	V23
W23	Y23
AA23	AB23
AC22	AC23
AE22	AE23

DC PAIR	
AG22	AG23
AJ22	AJ23
AL22	AL23
AN22	AN23
AP22	AP23
C23	C24
E23	E24
G23	G24
J23	J24
L23	L24
M24	N24
P24	R24
T24	U24
V24	W24
Y24	AA24
AB24	AC24
AD23	AD24
AF23	AF24
AH23	AH24
AK23	AK24
AM23	AM24
A24	A25
B24	B25
D24	D25
F24	F25
H24	H25
K24	K25
L25	M25
N25	P25
R25	T25
U25	V25
W25	Y25
AA25	AB25
AC25	AD25
AE24	AE25
AG24	AG25
AJ24	AJ25
AL24	AL25
AN24	AN25
AP24	AP25
C25	C26
E25	E26
G25	G26
J25	J26

DC PAIR	
K26	L26
M26	N26
P26	R26
T26	U26
V26	W26
Y26	AA26
AB26	AC26
AD26	AE26
AF25	AF26
AH25	AH26
AK25	AK26
AM25	AM26
A26	A27
B26	B27
D26	D27
F26	F27
H26	H27
J27	K27
L27	M27
N27	P27
R27	T27
U27	V27
W27	Y27
AA27	AB27
AC27	AD27
AE27	AF27
AG26	AG27
AJ26	AJ27
AL26	AL27
AN26	AN27
AP26	AP27
C27	C28
E27	E28
G27	G28
H28	J28
K28	L28
M28	N28
P28	R28
T28	U28
V28	W28
Y28	AA28
AB28	AC28
AD28	AE28
AF28	AG28

DC PAIR	
AH27	AH28
AK27	AK28
AM27	AM28
A28	A29
B28	B29
D28	D29
F28	F29
G29	H29
J29	K29
L29	M29
N29	P29
R29	T29
U29	V29
W29	Y29
AA29	AB29
AC29	AD29
AE29	AF29
AG29	AH29
AJ28	AJ29
AL28	AL29
AN28	AN29
AP28	AP29
C29	C30
E29	E30
F30	G30
H30	J30
K30	L30
M30	N30
P30	R30
T30	U30
V30	W30
Y30	AA30
AB30	AC30
AD30	AE30
AF30	AG30
AH30	AJ30
AK29	AK30
AM29	AM30
A30	A31
B30	B31
D30	D31
E31	F31
G31	H31
J31	K31

DC PAIR	
L31	M31
N31	P31
R31	T31
U31	V31
W31	Y31
AA31	AB31
AC31	AD31
AE31	AF31
AG31	AH31
AJ31	AK31
AL30	AL31
AN30	AN31
AP30	AP31
C31	C32
D32	E32
F32	G32
H32	J32
K32	L32
M32	N32
P32	R32
T32	U32
V32	W32
Y32	AA32
AB32	AC32
AD32	AE32
AF32	AG32
AH32	AJ32
AK32	AL32
AM31	AM32
A32	A33
B32	B33
C33	D33
E33	F33
G33	H33
J33	K33
L33	M33
N33	P33
R33	T33
U33	V33
W33	Y33
AA33	AB33
AC33	AD33
AE33	AF33
AG33	AH33

DC PAIR	
AJ33	AK33
AL33	AM33
AN32	AN33
AP32	AP33
B34	C34
D34	E34
F34	G34
H34	J34
K34	L34
M34	N34
P34	R34
T34	U34
V34	W34
Y34	AA34
AB34	AC34
AD34	AE34
AF34	AG34
AH34	AJ34
AK34	AL34
AM34	AN34

TopLine®			
TITLE		LGA1152T1.0G20-DC344D DAISY CHAIN DUMMY	
SCALE	SIZE	DRAWING NO.	REV
2.5:1	A	513448	A
DO NOT SCALE DRAWING			SHEET 10 OF 17

TOP LAYER - LAYER 1

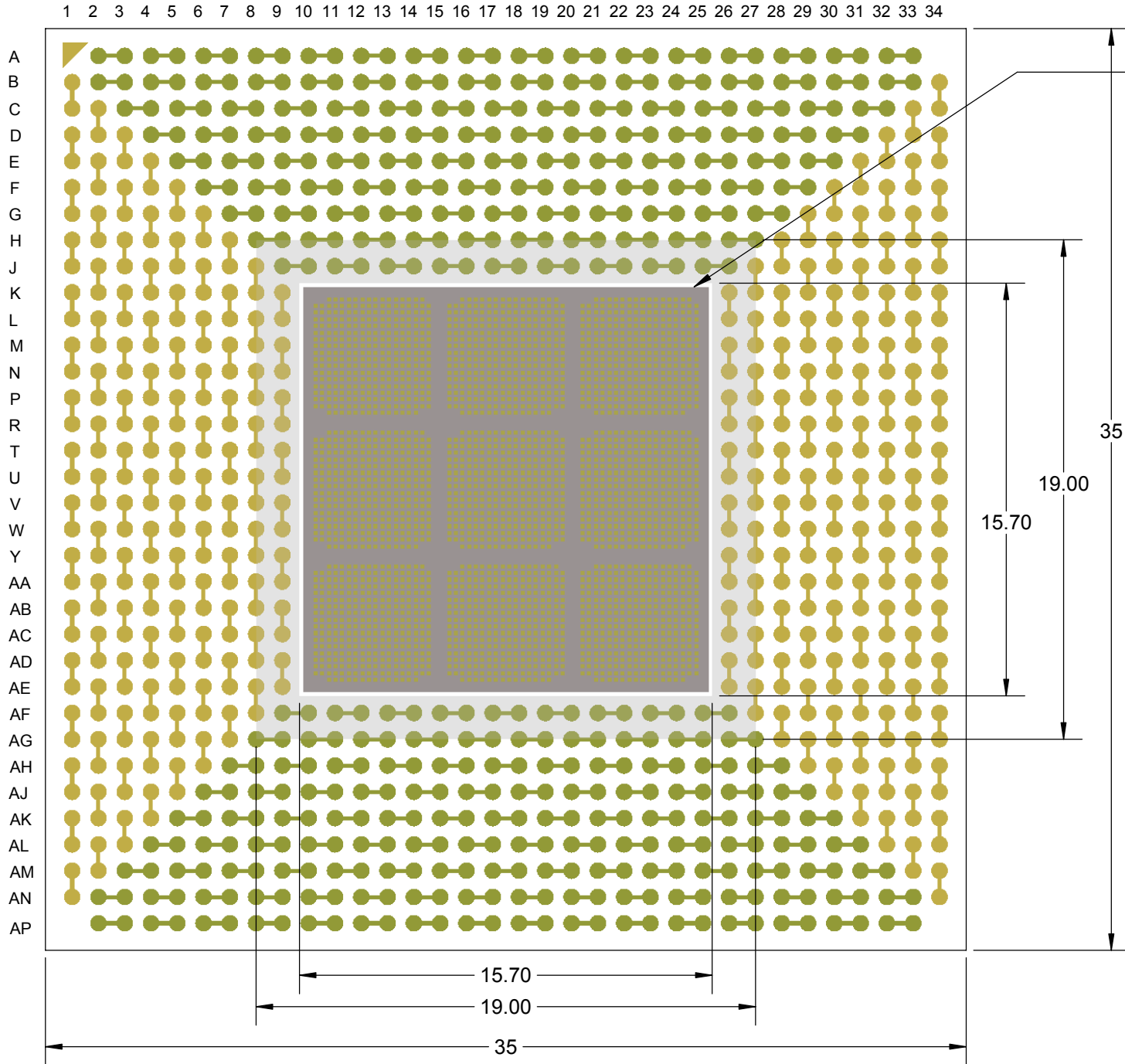

SEE DETAIL B
PAGE 17

TopLine®			
TITLE LGA1152T1.0G20-DC344D DAISY CHAIN DUMMY			
SCALE 4.5:1	SIZE A	DRAWING NO. 513448	REV A
DO NOT SCALE DRAWING			SHEET 11 OF 17

SOLDER MASK TOP

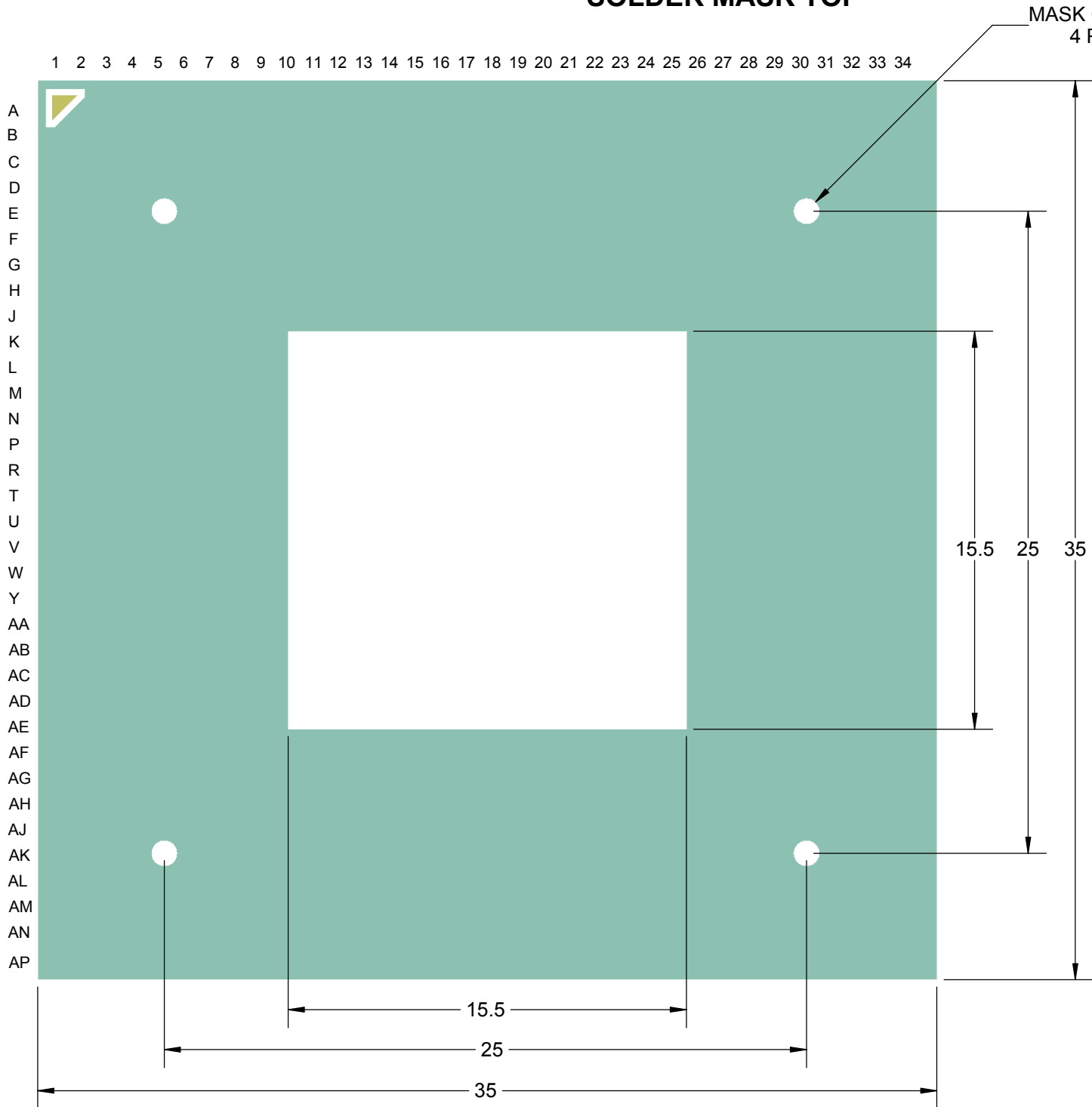

TopLine®			
TITLE LGA1152T1.0G20-DC344D DAISY CHAIN DUMMY			
SCALE 4.5:1	SIZE A	DRAWING NO. 513448	REV A
DO NOT SCALE DRAWING			SHEET 12 OF 17

GROUND PLANE - LAYER 2

1 2 3 4 5 6 7 8 9 10 11 12 13 14 15 16 17 18 19 20 21 22 23 24 25 26 27 28 29 30 31 32 33 34

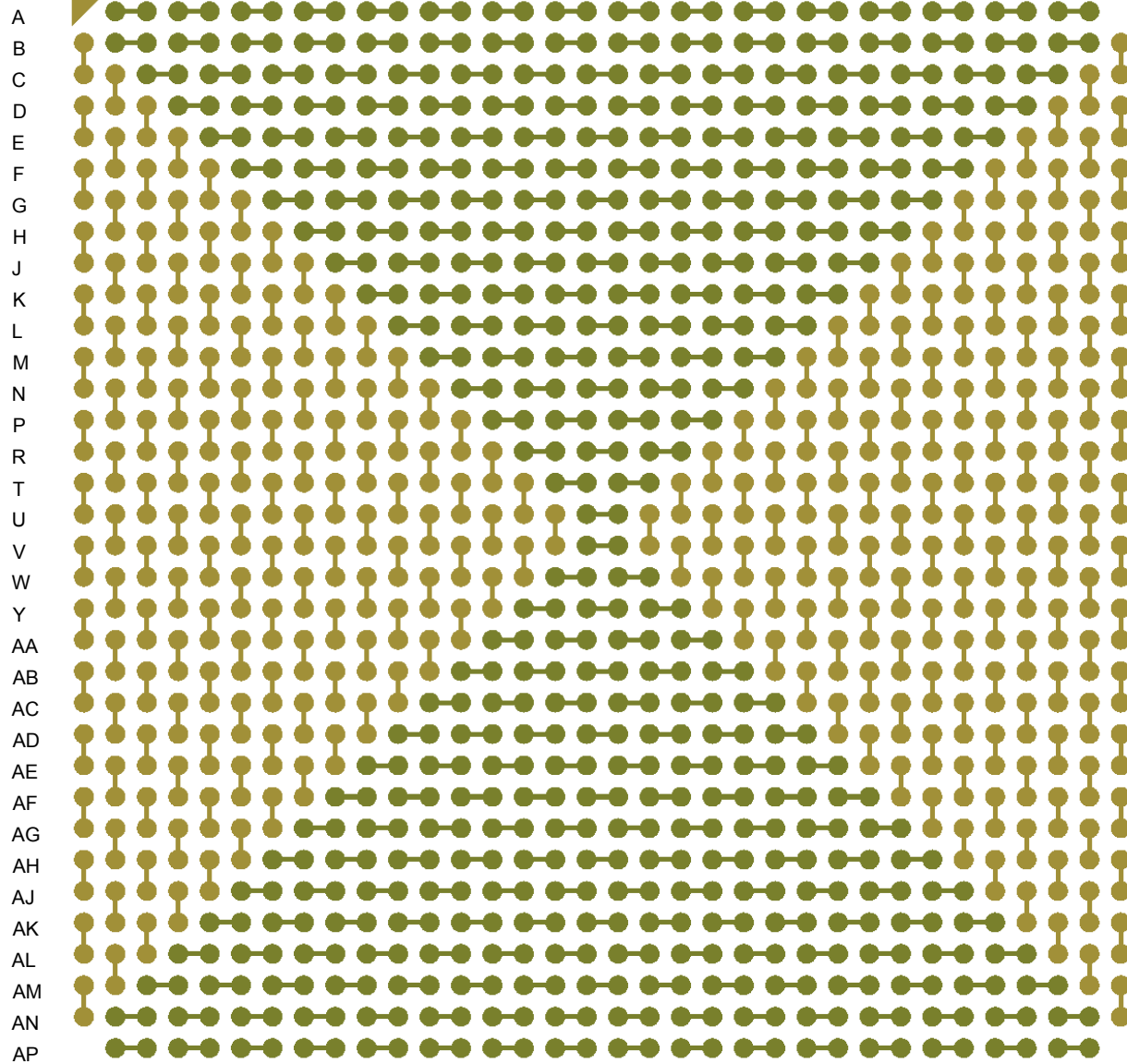

TopLine®

TITLE LGA1152T1.0G20-DC344D
DAISY CHAIN DUMMY

SCALE 4.5:1	SIZE A	DRAWING NO. 513448	REV A
----------------	-----------	-----------------------	----------

GROUND PLANE - LAYER 3

1 2 3 4 5 6 7 8 9 10 11 12 13 14 15 16 17 18 19 20 21 22 23 24 25 26 27 28 29 30 31 32 33 34



TopLine®			
TITLE LGA1152T1.0G20-DC344D DAISY CHAIN DUMMY			
SCALE 4.5:1	SIZE A	DRAWING NO. 513448	REV A
DO NOT SCALE DRAWING			SHEET 14 OF 17

BOTTOM SIDE (TOP X-RAY VIEW) - LAYER 4

1 2 3 4 5 6 7 8 9 10 11 12 13 14 15 16 17 18 19 20 21 22 23 24 25 26 27 28 29 30 31 32 33 34

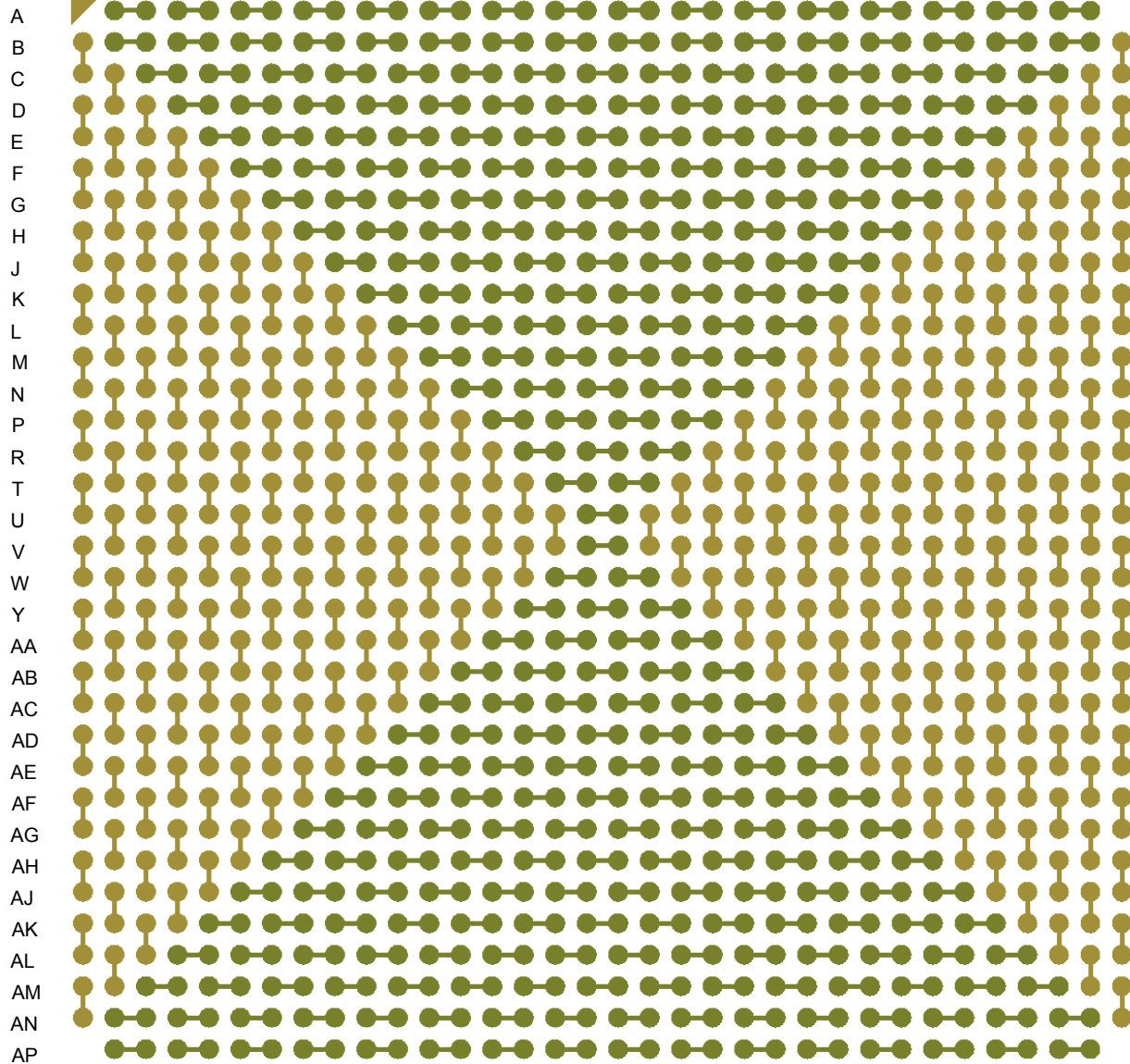

TopLine®			
TITLE LGA1152T1.0G20-DC344D DAISY CHAIN DUMMY			
SCALE 4.5:1	SIZE A	DRAWING NO. 513448	REV A
DO NOT SCALE DRAWING			SHEET 15 OF 17

BOTTOM SOLDER MASK (RIGHT READING)

34 33 32 31 30 29 28 27 26 25 24 23 22 21 20 19 18 17 16 15 14 13 12 11 10 9 8 7 6 5 4 3 2 1

A
B
C
D
E
F
G
H
J
K
L
M
N
P
R
T
U
V
W
Y
AA
AB
AC
AD
AE
AF
AG
AH
AJ
AK
AL
AM
AN
AP

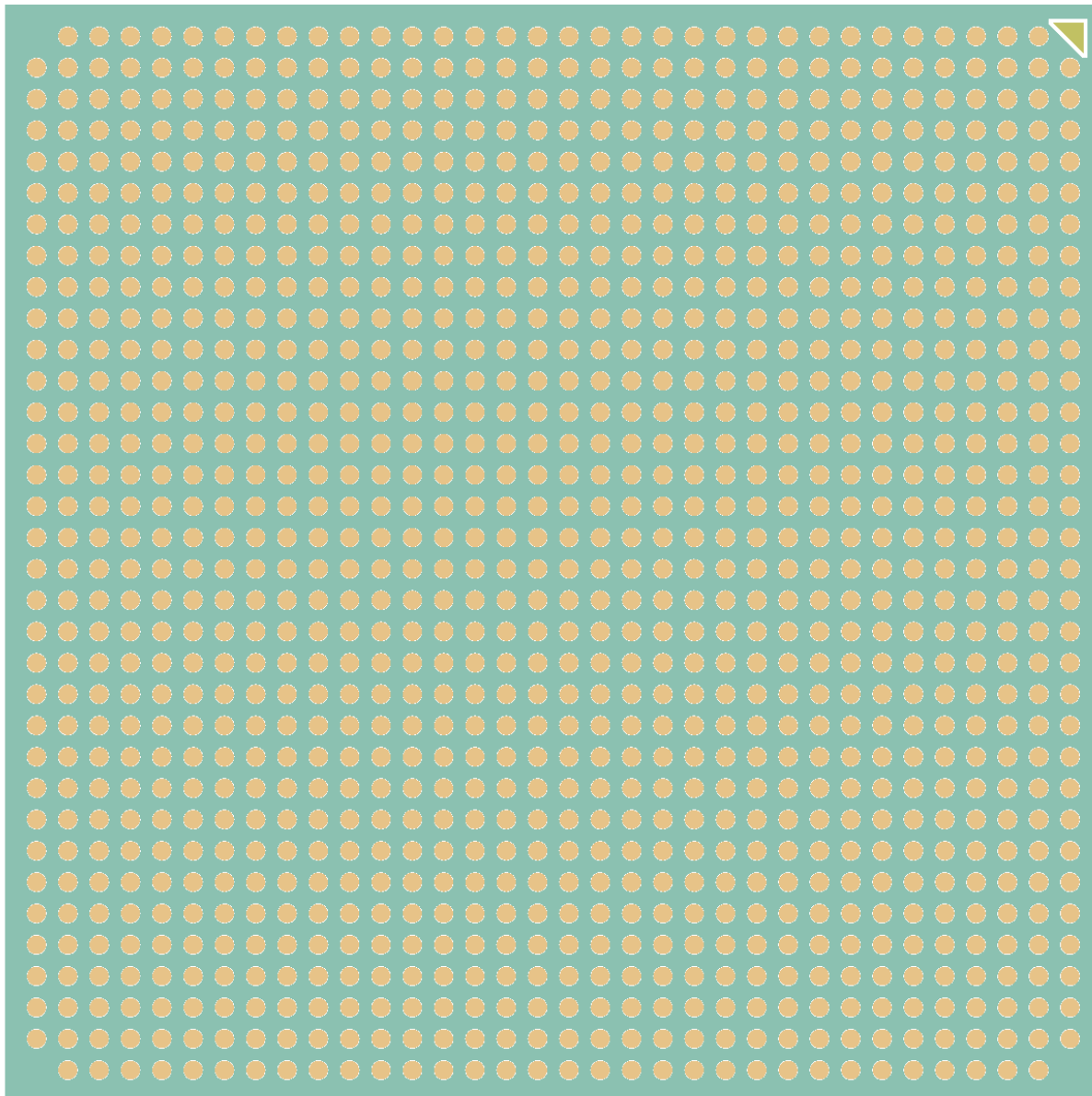

TopLine®			
TITLE		LGA1152T1.0G20-DC344D DAISY CHAIN DUMMY	
SCALE	SIZE	DRAWING NO.	REV
4.5:1	A	513448	A
DO NOT SCALE DRAWING			SHEET 16 OF 17

DETAIL B PCB DIE PADS (TOP) Micron (μm)

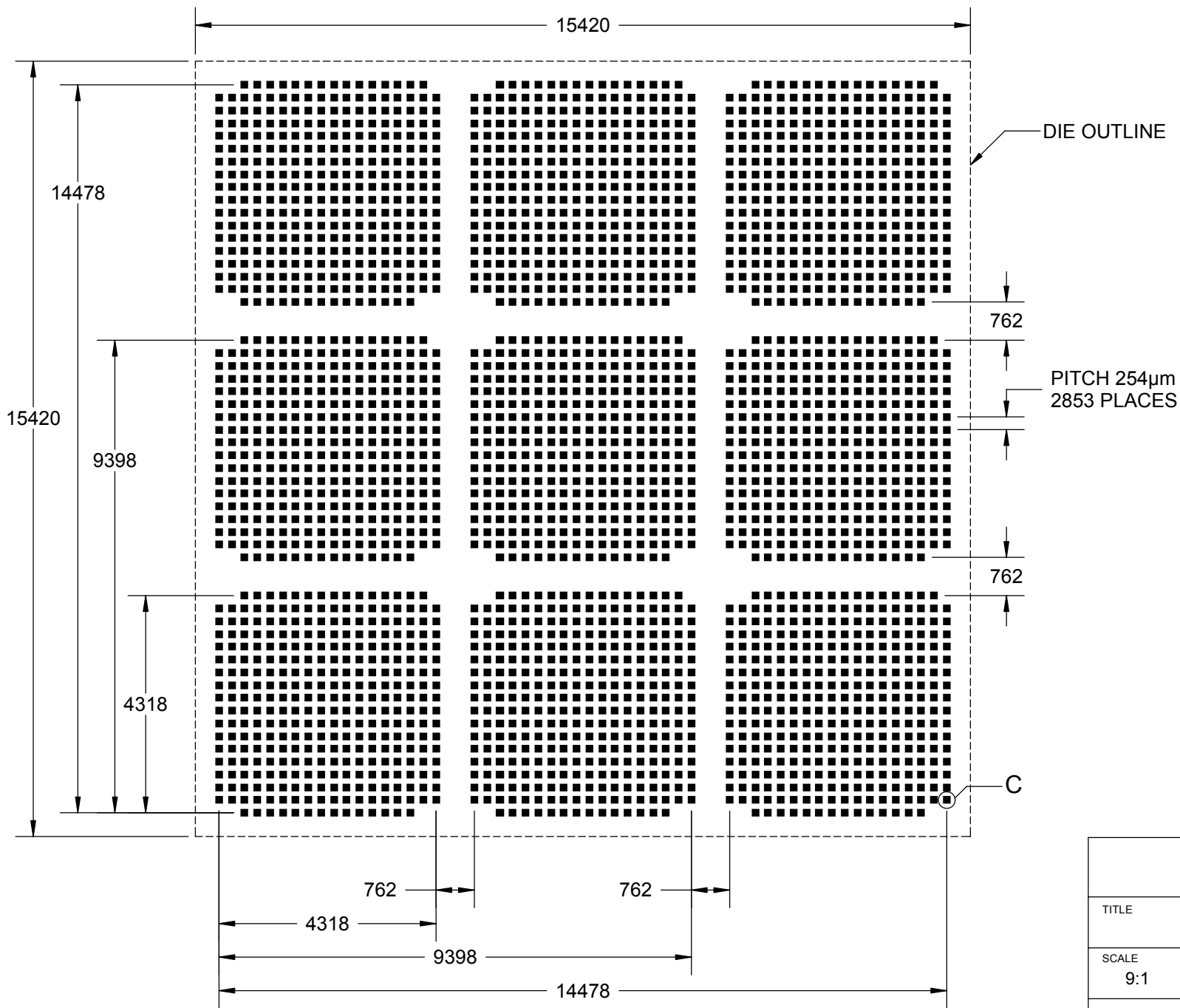

DETAIL C PAD SIZE

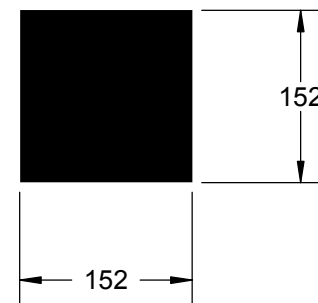

TopLine®			
TITLE		FLIP CHIP DIE PAD 15 x 15mm	
SCALE	SIZE	DRAWING NO.	REV
9:1	A	513448	A
DO NOT SCALE DRAWING			SHEET 17 OF 17