

CBGA WITH DIE

TOP VIEW

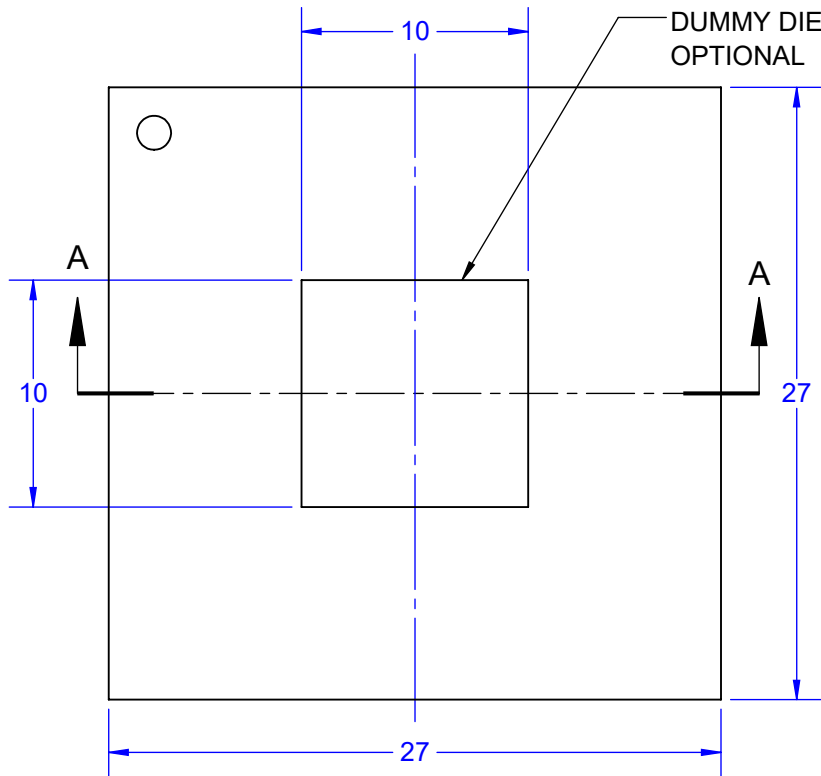

BALL VIEW

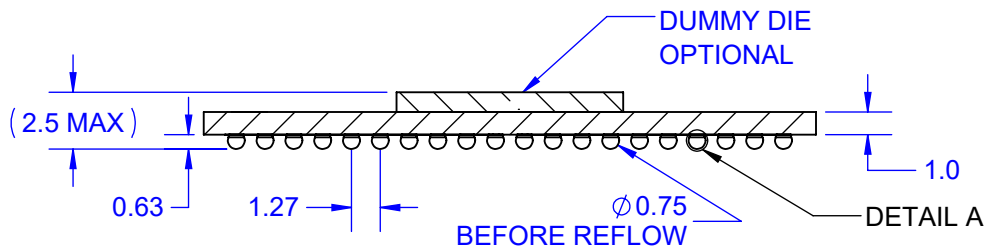
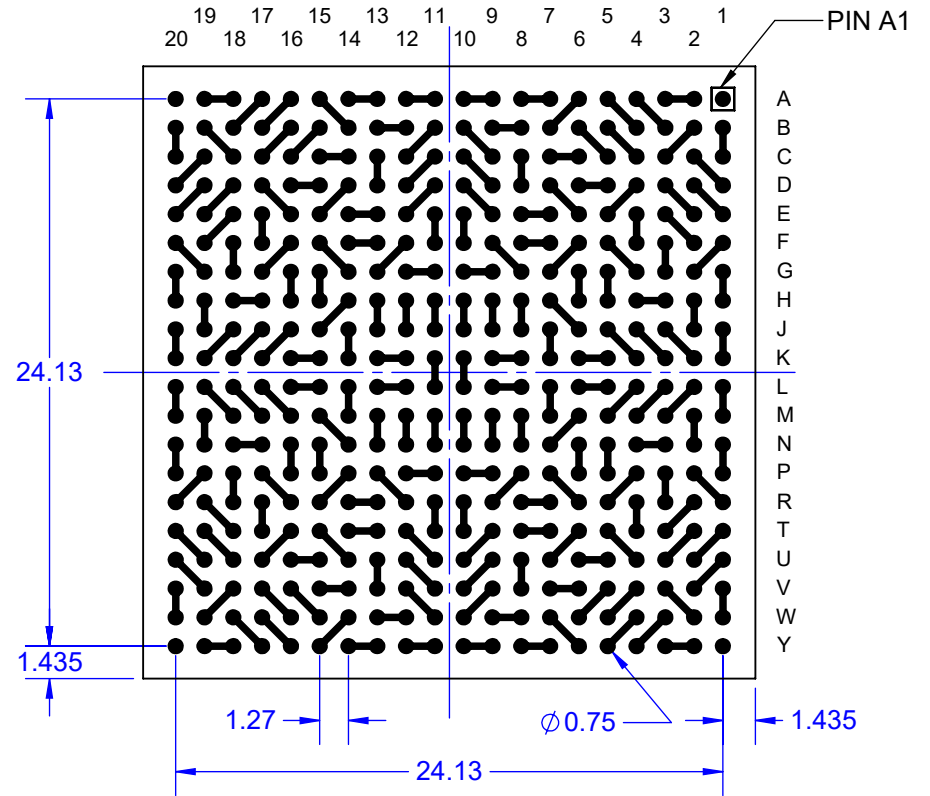

SECTION A-A
SCALE 3 : 1

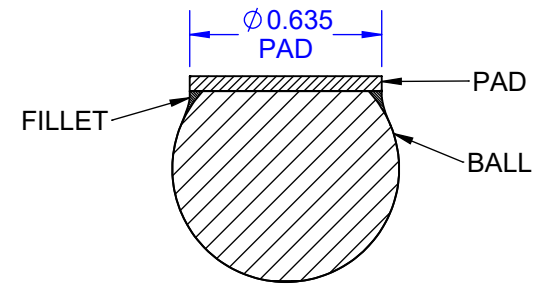

DETAIL A

Notes: (Unless Otherwise Specified).

- 1) ALL DIMENSIONS ARE MM.
- 2) SOLDER BALL ALLOY: SEE PART NUMBER CONFIGURATION.
- 3) BALL DIAMETER (BEFORE REFLOW): 0.76mm (30 MIL).
- 4) SOLDER MASK OPENING: 0.635mm (25 MIL).
- 5) SUBSTRATE: ALUMINA CERAMIC.

APPROVALS		DATE				
DRAWN	T. Au	07/24/2022				
ENG	M. Hart	07/24/2022	SCALE		SIZE	DRAWING NO.
MFG			6:1		A	520217
QA					REV	A
CUST						
REVISED			DO NOT SCALE DRAWING			SHEET 1 OF 6

TOP VIEW

CBGA WITHOUT DIE

BALL VIEW

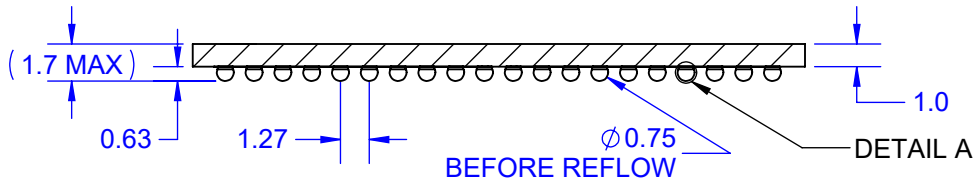
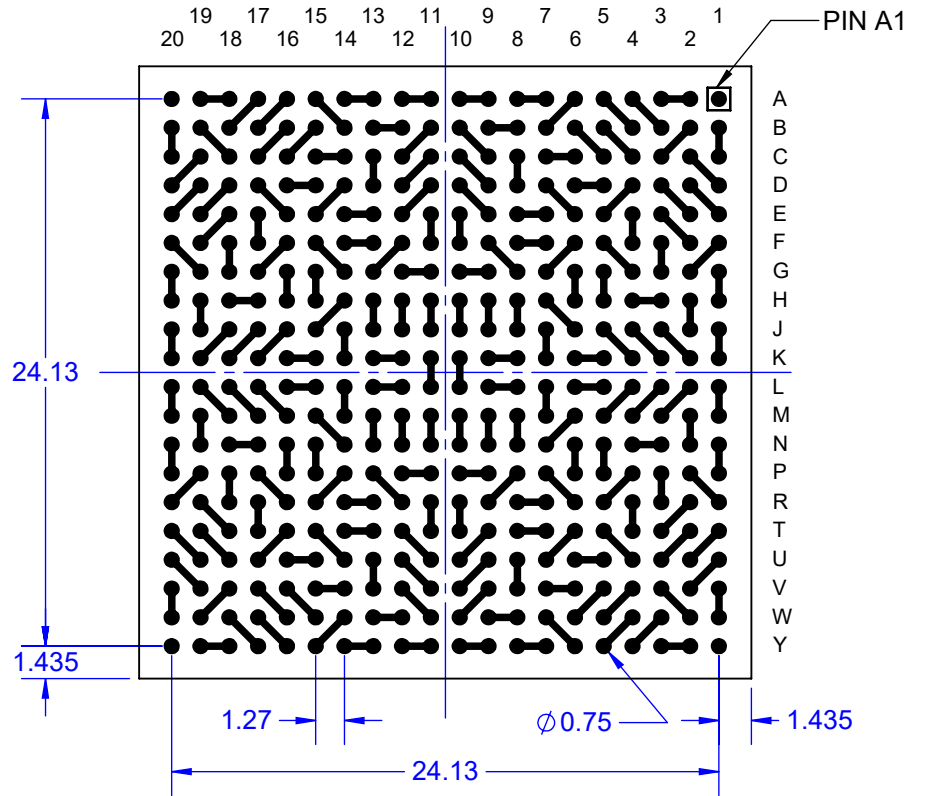
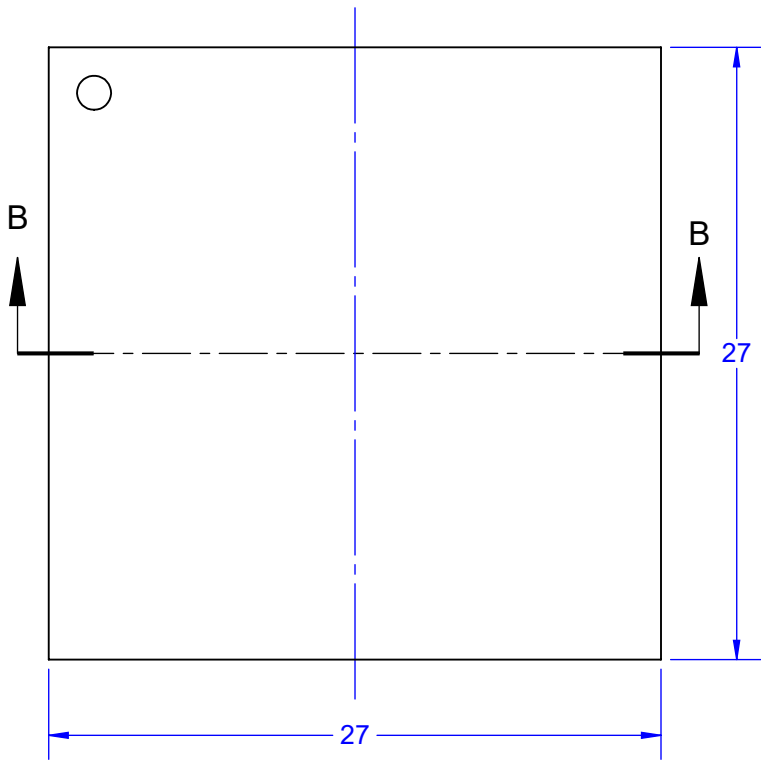

SECTION B-B
SCALE 3 : 1

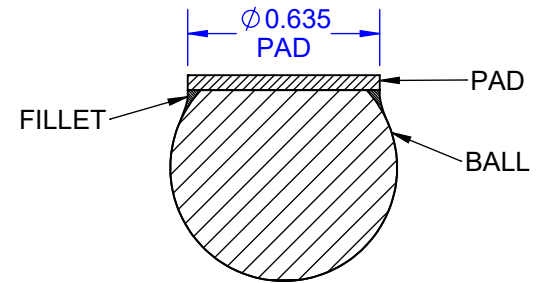

DETAIL A

Notes: (Unless Otherwise Specified).

- 1) ALL DIMENSIONS ARE MM.
- 2) SOLDER BALL ALLOY: SEE PART NUMBER CONFIGURATION.
- 3) BALL DIAMETER (BEFORE REFLOW): 0.76mm (30 MIL).
- 4) SOLDER MASK OPENING: 0.635mm (25 MIL).
- 5) SUBSTRATE: ALUMINA CERAMIC.

APPROVALS	DATE	TopLine [®]			
DRAWN T. Au	07/24/2022				
ENG M. Hart	07/24/2022	TITLE CBGA400T1.27L-DC21 CERAMIC BALL GRID ARRAY			
MFG		SCALE	SIZE	DRAWING NO.	REV
QA		6:1	A	520217	A
CUST		DO NOT SCALE DRAWING			SHEET 2 OF 6
REVISED					

BALL VIEW

20 19 18 17 16 15 14 13 12 11 10 9 8 7 6 5 4 3 2 1

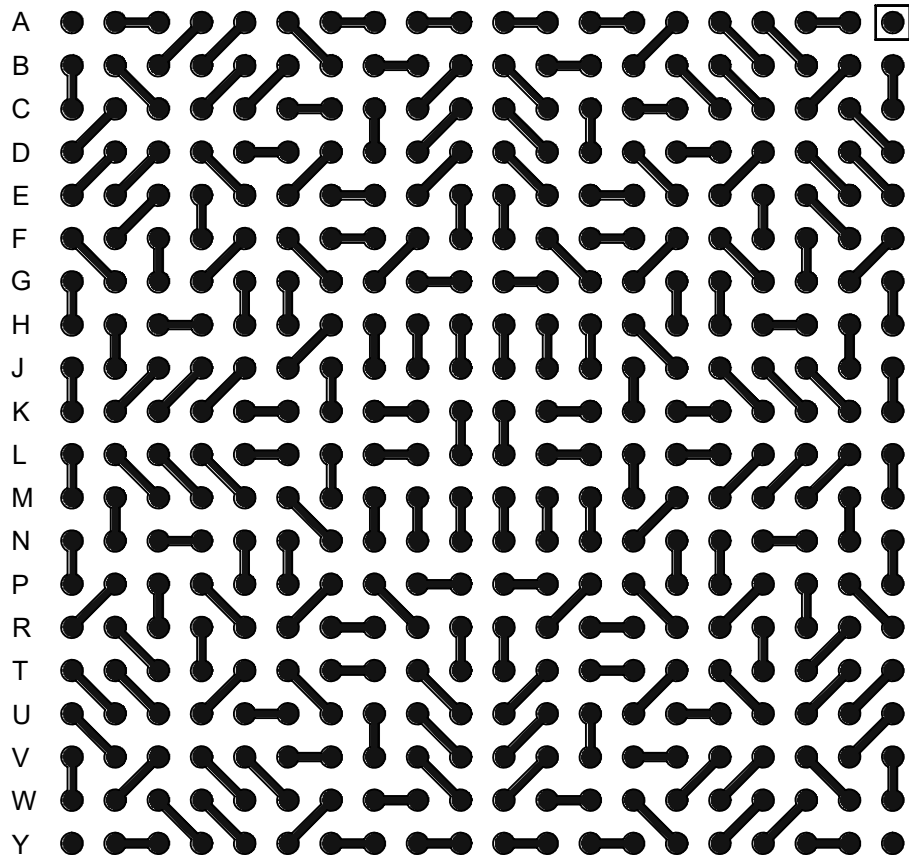

BOTTOM SIDE (TOP X-RAY VIEW)

1 2 3 4 5 6 7 8 9 10 11 12 13 14 15 16 17 18 19 20

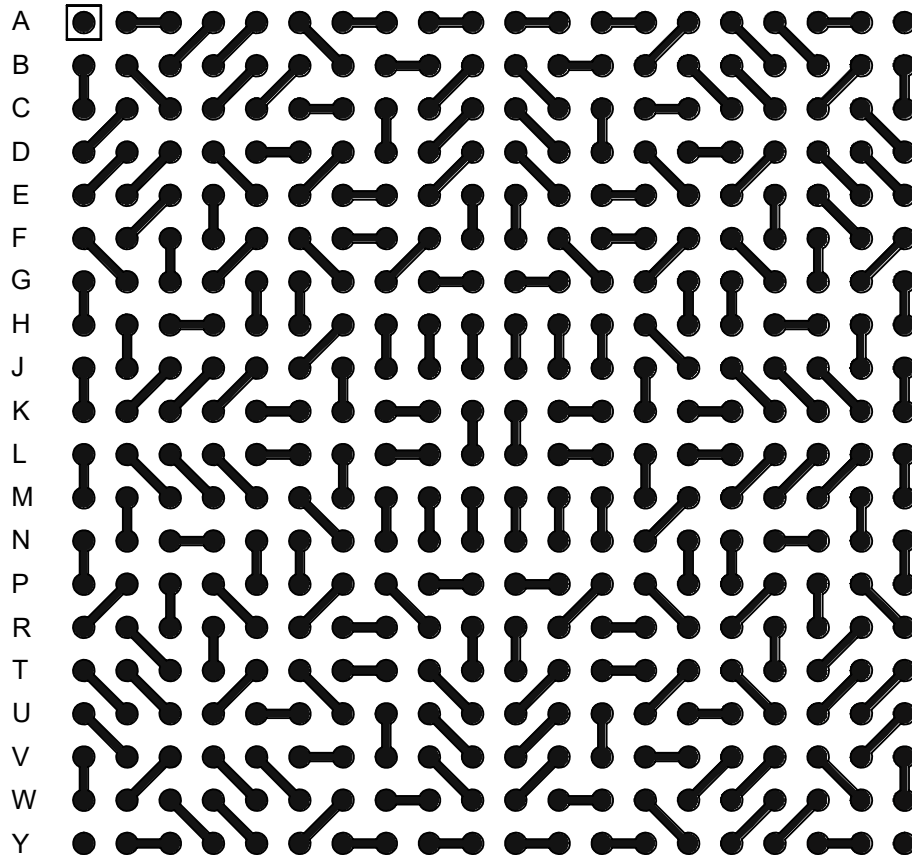

TopLine

TITLE CBGA400T1.27L-DC21
CERAMIC BALL GRID ARRAY

SCALE 4.5:1	SIZE A	DRAWING NO. 520217	REV A
----------------	-----------	-----------------------	----------

DO NOT SCALE DRAWING SHEET 3 OF 6

**MODEL
CBGA WITH BALL
WITHOUT DIE**

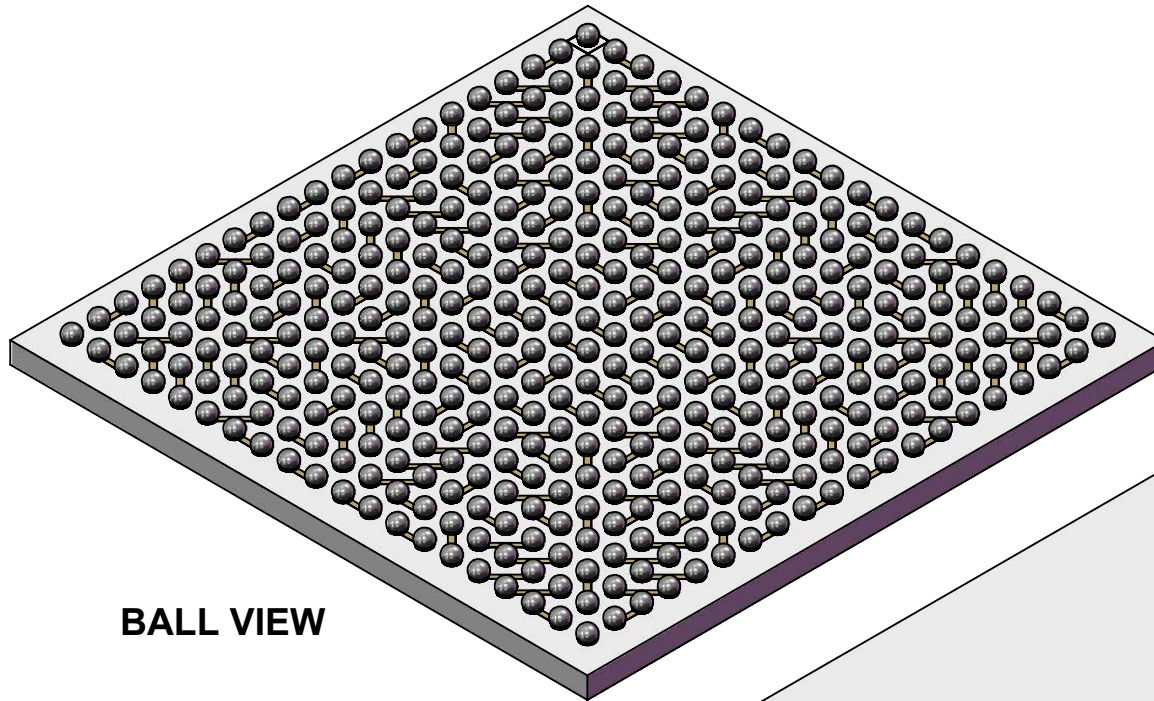

BALL VIEW

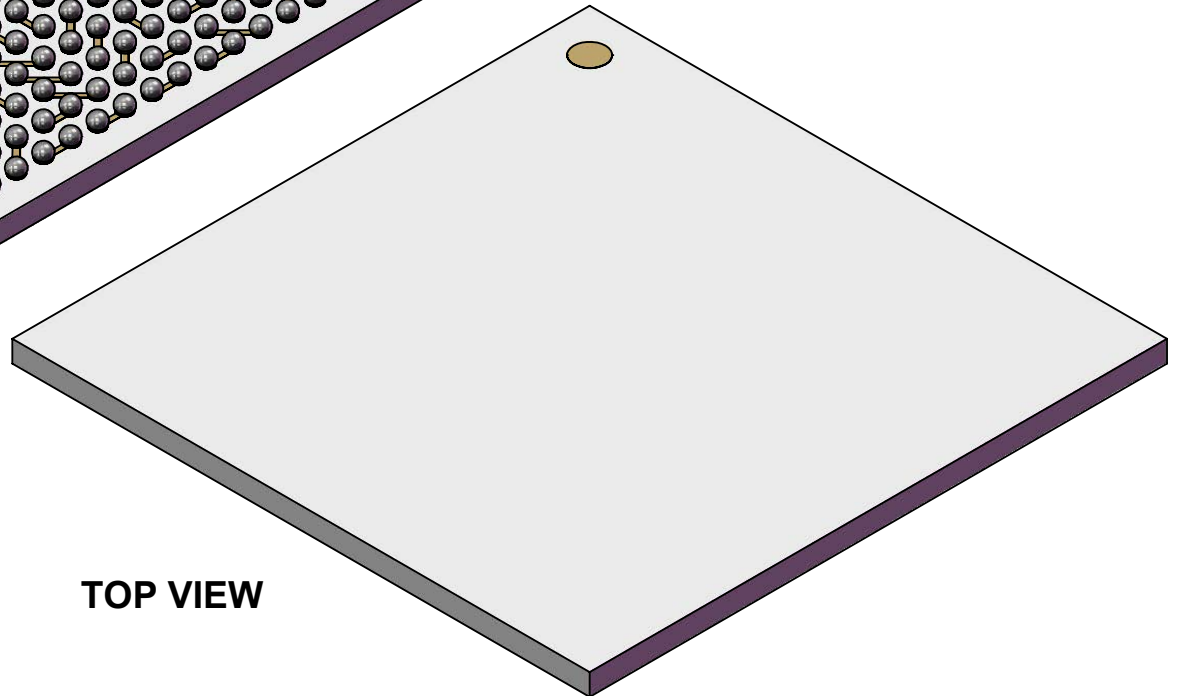

TOP VIEW

TopLine[®]

TITLE CBGA400T1.27L-DC21
 CERAMIC BALL GRID ARRAY

SCALE 4:1	SIZE A	DRAWING NO. 520217	REV A
--------------	-----------	-----------------------	----------

DO NOT SCALE DRAWING

SHEET 4 OF 6

**MODEL
CBGA WITH BALL
WITH DIE**

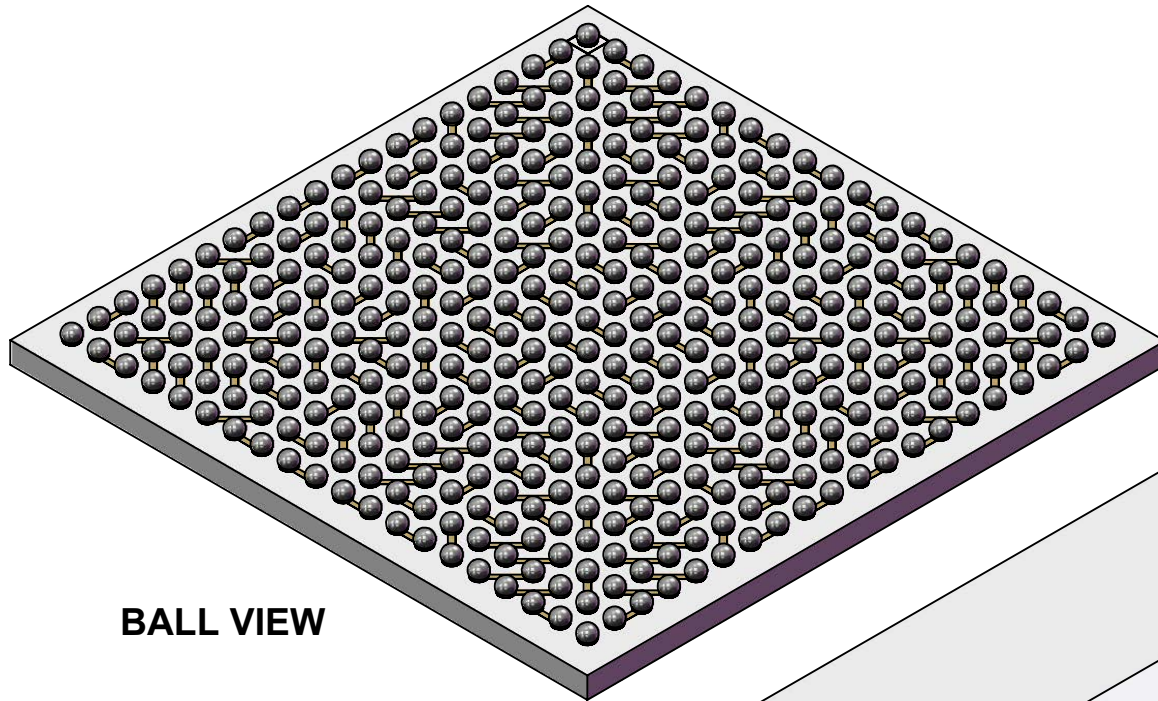

BALL VIEW

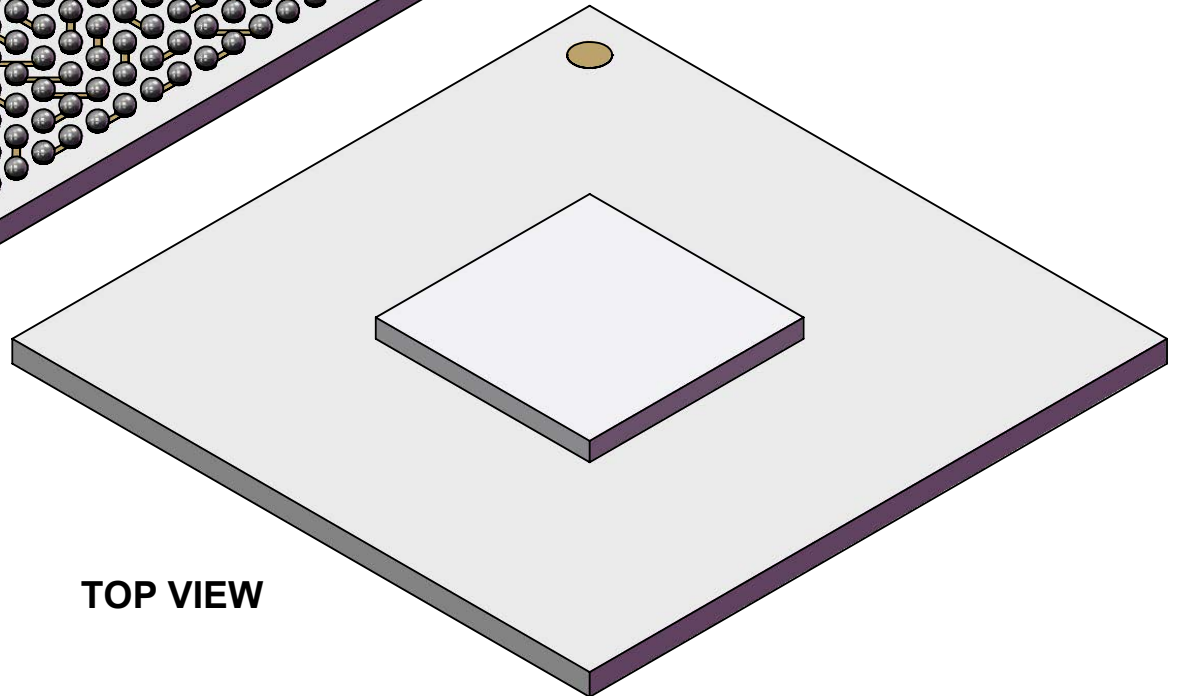

TOP VIEW

TopLine[®]

TITLE CBGA400T1.27L-DC21D
 CERAMIC BALL GRID ARRAY

SCALE 4:1	SIZE A	DRAWING NO. 520217	REV A
--------------	-----------	-----------------------	----------

DO NOT SCALE DRAWING

SHEET 5 OF 6

PART NUMBER SYSTEM

CBGA

400

T

1.27

C

-

DC21

D

SERIES

CBGA = CERAMIC
BALL GRID ARRAY

BALLS

NBR SOLDER
BALLS/PADS

TRAY

T = JEDEC

PITCH

1.27mm = 0.050"

ALLOY

L = Sn62/Pb36/Ag2.0
X = Sn63/Pb37
C = SAC305
Blank = Sn10/Pb90

DIE

D = DUMMY DIE
BLANK = WITHOUT DIE

DAISY CHAIN

DC21 = SEE PATTERN

PART NUMBER	BALL ALLOY	CODE	LEAD FREE	DIE
CBGA400T1.27-DC21	Sn10/Pb90	Sn10	NO	NO
CBGA400T1.27-DC21D	Sn10/Pb90	Sn10	NO	YES
CBGA400T1.27L-DC21	Sn62/Pb36/Ag2.0	Sn62	NO	NO
CBGA400T1.27L-DC21D	Sn62/Pb36/Ag2.0	Sn62	NO	YES
CBGA400T1.27X-DC21	Sn63/Pb37	Sn63	NO	NO
CBGA400T1.27X-DC21D	Sn63/Pb37	Sn63	NO	YES
CBGA400T1.27C-DC21	Sn96.5/Ag3.0/Cu0.5	SAC305	YES	NO
CBGA400T1.27C-DC21D	Sn96.5/Ag3.0/Cu0.5	SAC305	YES	YES

TopLine®			
TITLE CBGA400T1.27L-DC21 CERAMIC BALL GRID ARRAY			
SCALE NONE	SIZE A	DRAWING NO. 520217	REV A
DO NOT SCALE DRAWING			SHEET 6 OF 6