

Notes: (Unless Otherwise Specified).

- 1) DIMENSIONS: INCH [mm].
- 2) FLAT LEADS ON TIE BAR ALLOY 42.
- 3) ALL EXPOSED METAL GOLD PLATED (Au).
- 4) PINS = 24, PITCH 0.050" [1.27mm].

TOLERANCE UNLESS NOTED		APPROVALS		DATE	TopLine [®]				
X.XX	+/- 0.01	DRAWN J. HINES		7/12/2014					TITLE 24 PIN 0.050 INCH PITCH FP24F50R.60X.82B-A DUMMY
X.XXX	+/- 0.005	ENG			SCALE 3.5:1		SIZE A	DRAWING NO. 122469	REV A
X.XXXX	+/- 0.0005	MFG			DO NOT SCALE DRAWING				
ANGLES +/- 0.5°		QA			SHEET 1 OF 5				
ALL DIMENSIONS IN <input checked="" type="checkbox"/> INCHES <input type="checkbox"/> MILLIMETERS		CUST							
THIRD ANGLE PROJECTION		REVISED							

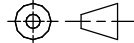

TOP

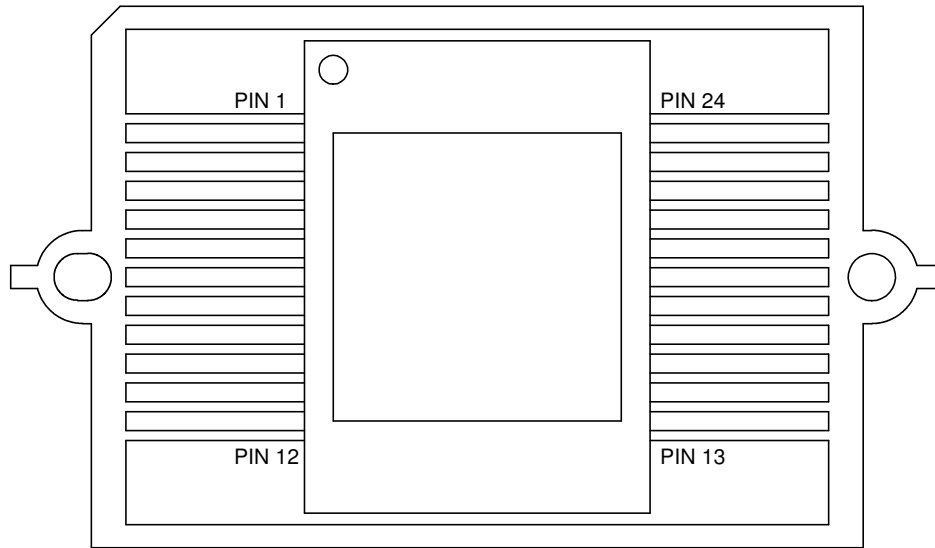

SIDE

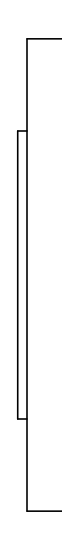

SIDE

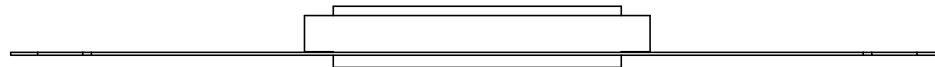

BOTTOM

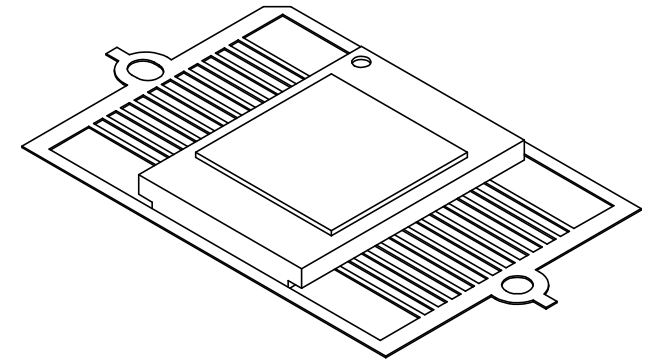
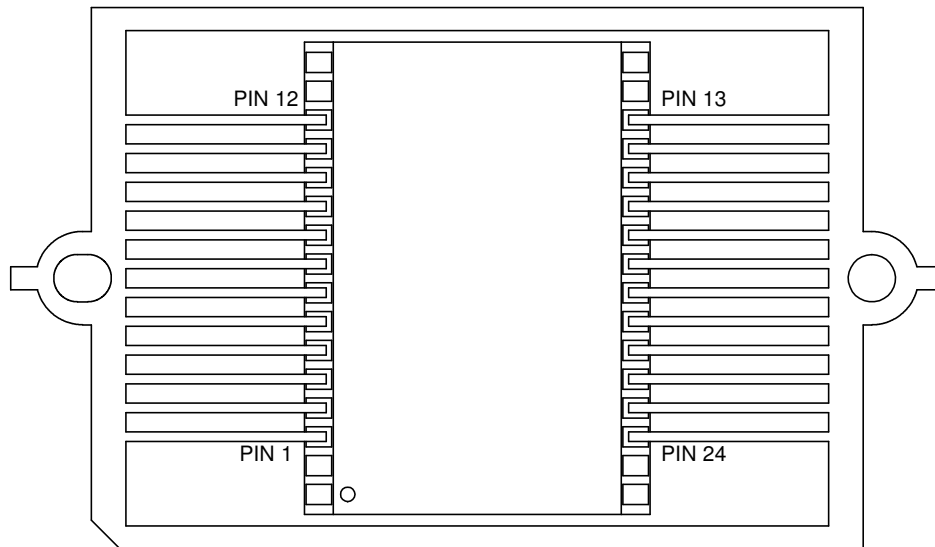

ISOMETRIC VIEW
SCALE 2:1

TopLine®

TITLE 24 PIN 0.050 INCH PITCH
FP24F50R.60X.82B-A DUMMY

SCALE	SIZE	DRAWING NO.	REV
3:1	A	122469	A

DO NOT SCALE DRAWING

SHEET 2 OF 5

LEAD FRAME
(SHOWN WITHOUT BODY)
TOP VIEW

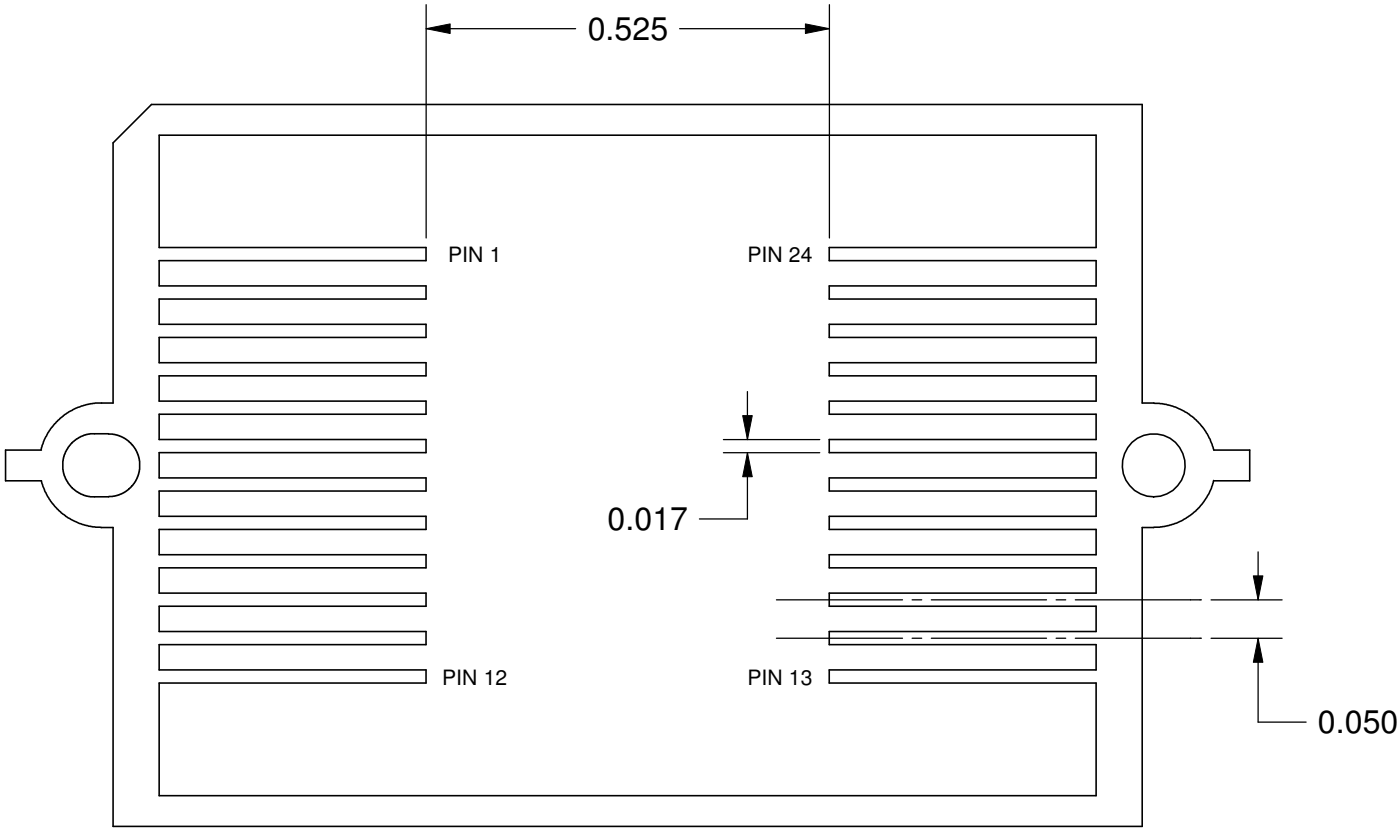

TopLine®

TITLE 24 PIN 0.050 INCH PITCH
FP24F50R.60X.82B-A DUMMY

SCALE	SIZE	DRAWING NO.	REV
4:1	A	122469	A

DO NOT SCALE DRAWING

SHEET 3 OF 5

PIN 1 MARK $\varnothing 0.050 \nabla 0.010$

TOP

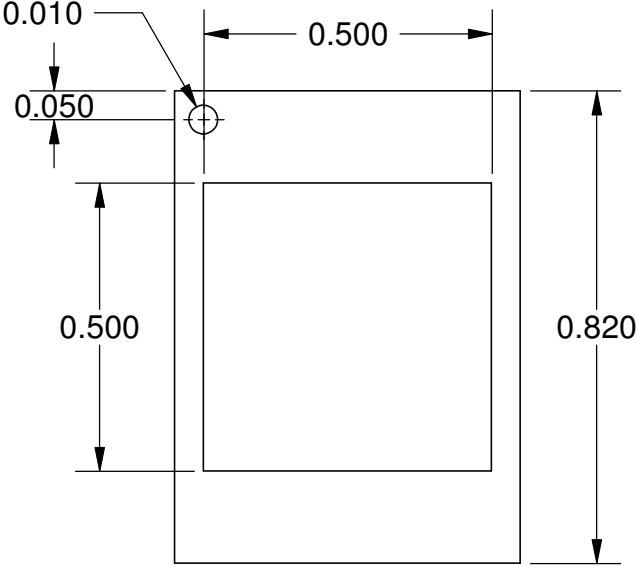

SIDE

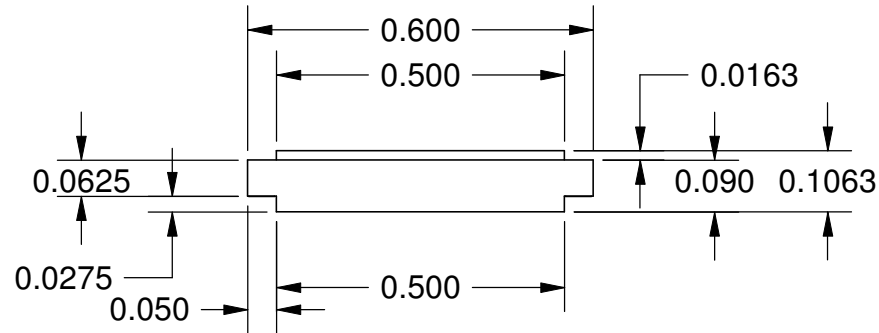

BOTTOM

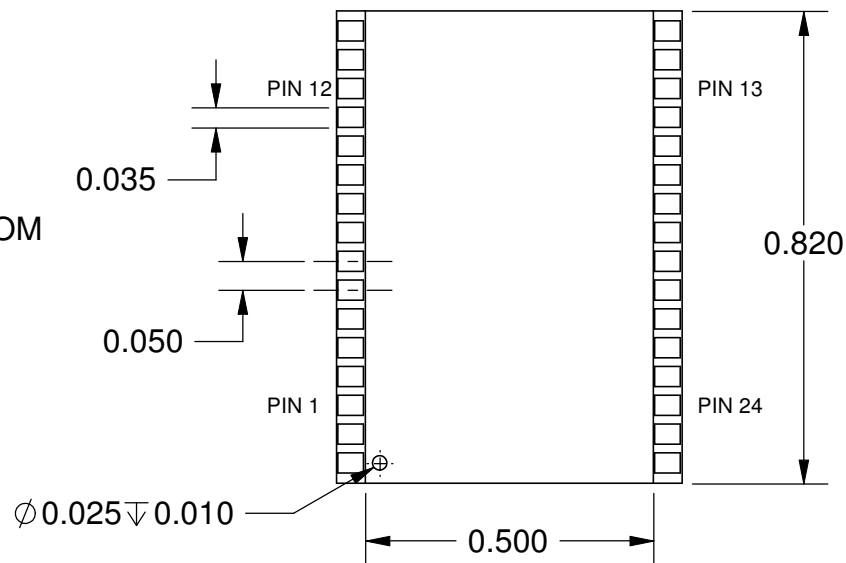

TopLine®

TITLE 24 PIN 0.050 INCH PITCH
FP24F50R.60X.82B-A DUMMY

SCALE	SIZE	DRAWING NO.	REV
3:1	A	122469	A

DO NOT SCALE DRAWING

SHEET 4 OF 5

NET LIST
COMMON BUS SHORT

PIN
1
2
3
4
5
6
7
8
9
10
11
12
13
14
15
16
17
18
19
20
21
22
23
24

NOTE: ALL PINS ARE SHORTED

			
TITLE 24 PIN 0.050 INCH PITCH FP24F50R.60X.82B-A DUMMY			
SCALE 3:1	SIZE A	DRAWING NO. 122469	REV A
DO NOT SCALE DRAWING		SHEET 5 OF 5	