

| REVISIONS | | | | |
|-----------|------|-----|-------------|----------|
| DATE | REV. | ECO | DESCRIPTION | APPROVED |

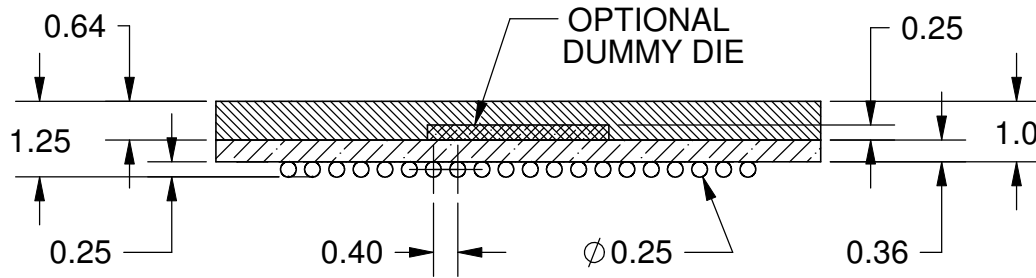
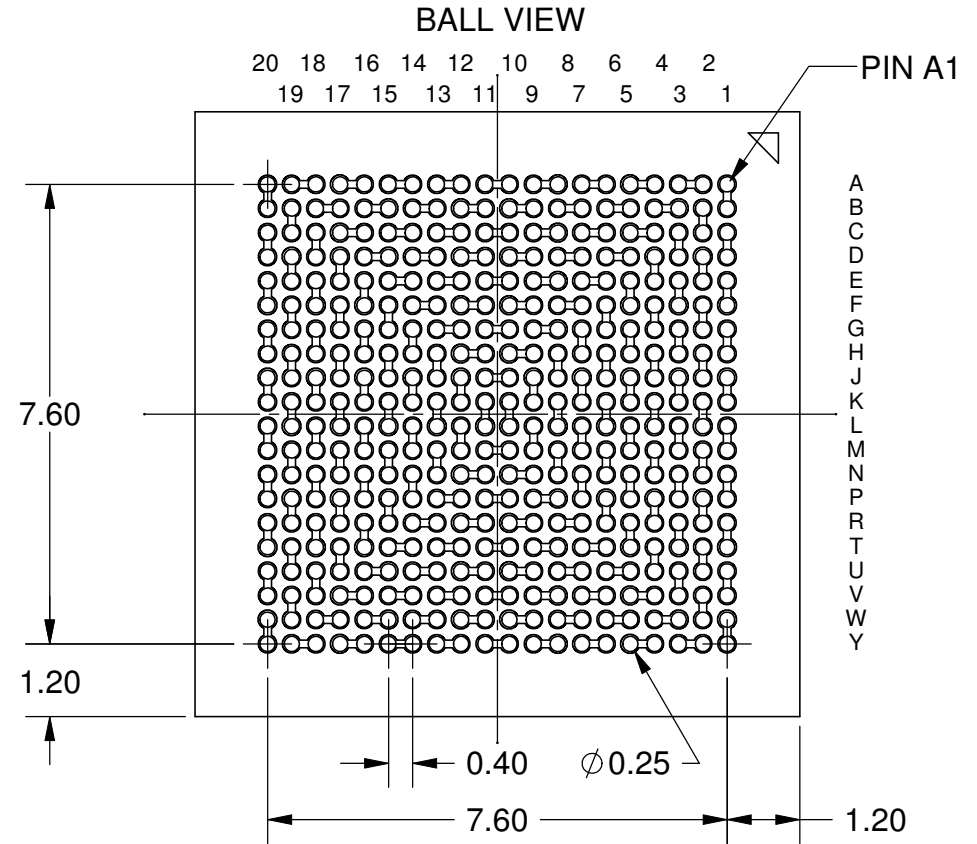
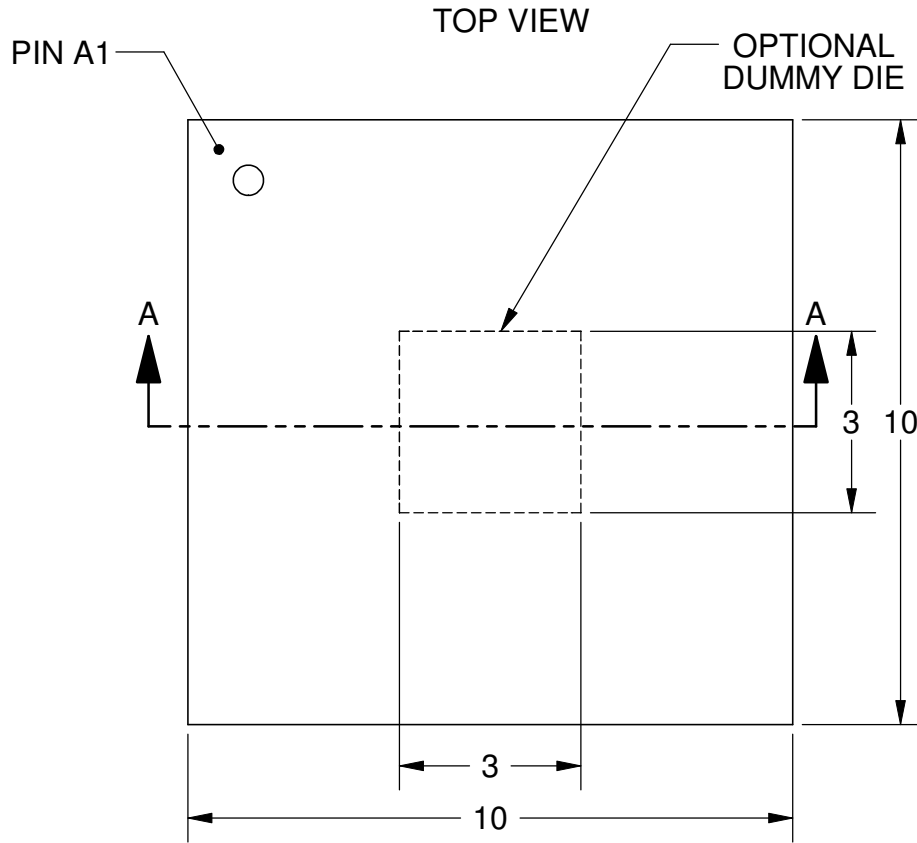

SECTION A-A

Notes: (Unless Otherwise Specified).

- 1) ALL DIMENSIONS ARE IN MM.
- 2) SOLDER BALL ALLOY: SEE PART NUMBER TABLE.
- 3) BALL DIAMETER (BEFORE REFLOW): 0.25mm.
- 4) SOLDER MASK DEFINED PAD OPENING: 0.22mm [8.7 MIL].
- 5) PAD Cu DIAMETER: 0.305mm [12 MIL].
- 6) SUBSTRATE MATERIAL: BT (ALTERNATE FR4).
- 7) DUMMY DIE IS OPTIONAL.
- 8) DAISY CHAIN PATTERN (SEE PAGE 2).
- 9) MSL-3 RECOMMEND BAKING 24 HOURS @ 125C TO REMOVE MOISTURE PRIOR TO SOLDERING TO PC BOARD.

| PART NUMBER TABLE | | | | |
|-------------------|--------------------|---------|------|--------|
| PART NUMBER | BALL ALLOY | Pb-FREE | RoHS | Si DIE |
| BGA400T.4C-DC209 | Sn96.5/Ag3.0/Cu0.5 | YES | YES | NO |
| BGA400T.4C-DC209D | Sn96.5/Ag3.0/Cu0.5 | YES | YES | YES |
| BGA400T.4-DC209 | Sn63/Pb37 | NO | NO | NO |
| BGA400T.4-DC209D | Sn63/Pb37 | NO | NO | YES |

| TOLERANCE UNLESS NOTED | | APPROVALS | | DATE |  | | | | |
|--|------------|----------------|--|-----------|---|--|--------|--------------------|---|
| X.XX | +/- 0.01 | DRAWN J. Hines | | 9/12/2010 | | | | | TITLE BGA400T.4-DC209 DAISY CHAIN DUMMY |
| X.XXX | +/- 0.005 | ENG | | | | | | | |
| X.XXXX | +/- 0.0005 | MFG | | | SCALE 8:1 | | SIZE A | DRAWING NO. 542091 | REV A |
| ANGLES +/- 0.5° | | QA | | | DO NOT SCALE DRAWING | | | | |
| ALL DIMENSIONS IN <input type="checkbox"/> INCHES <input checked="" type="checkbox"/> MILLIMETERS | | CUST | | | SHEET 1 OF 2 | | | | |
| THIRD ANGLE PROJECTION | | REVISED | | | | | | | |

BALL VIEW

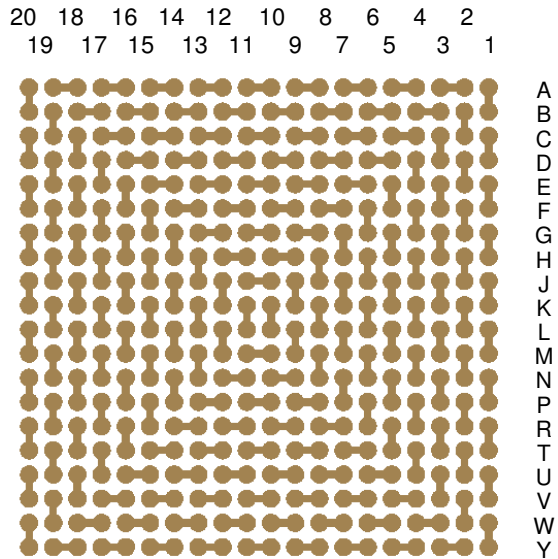

BOTTOM SIDE (TOP X-RAY VIEW)

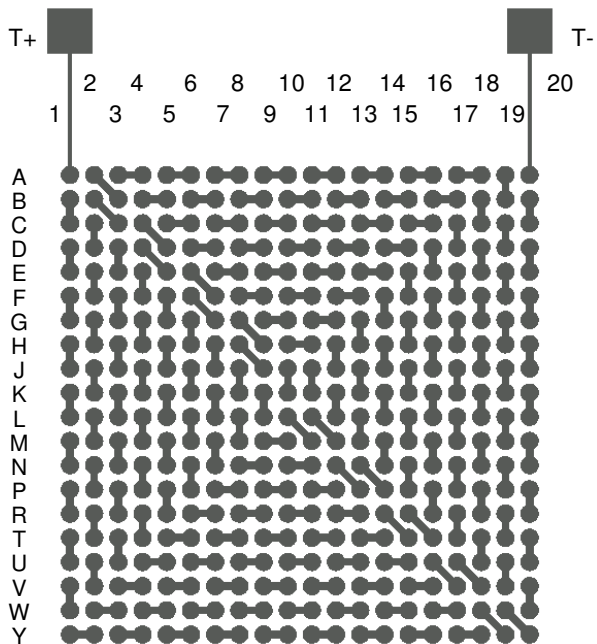
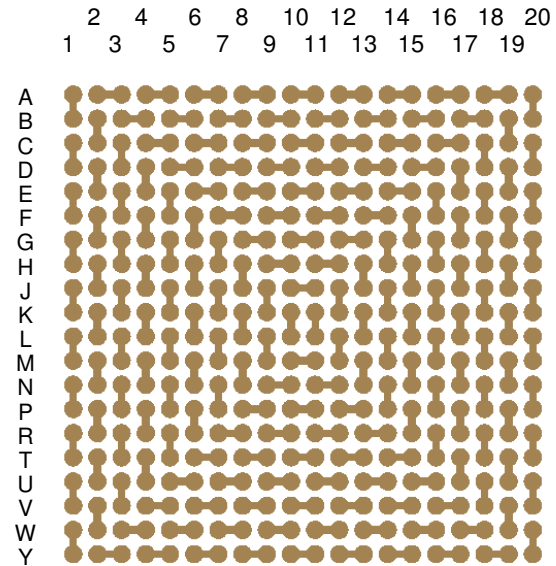

TEST VEHICLE BOARD

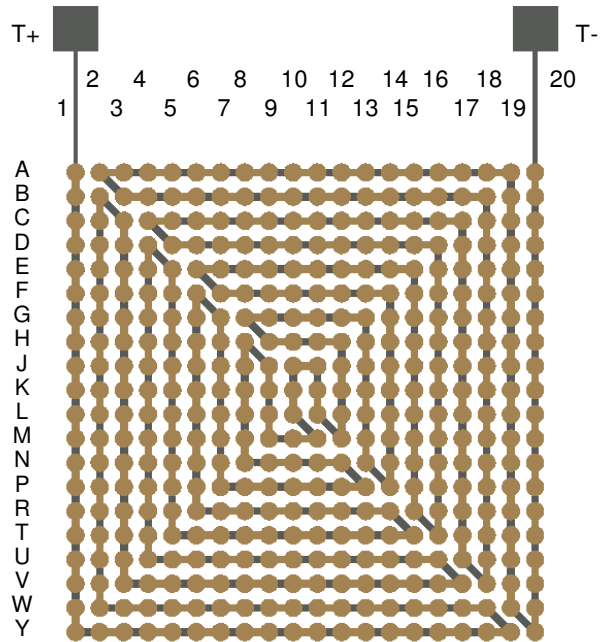

AFTER MOUNTING

Notes:

- 1) PCB BOARD DIMENSIONS ARE PRESENTED ONLY AS A GUIDELINE. DESIGNERS SHOULD USE THEIR OWN EXPERIENCE WHEN DESIGNING PCB.
- 2) PCB Cu BALL PAD DIAMETER 0.305mm [12 MIL].
- 3) PCB DAISY CHAIN TRACING LINE WIDTH 0.127mm [5 MIL].
- 4) SMD (SOLDER MASK DEFINED) PAD OPENING 0.22mm [8.7 MIL].



| | | | |
|--------------------------------------|------|-------------|--------------|
| TITLE | | | |
| BGA400T.4-DC209 DAISY CHAIN DUMMY | | | |
| SCALE | SIZE | DRAWING NO. | REV |
| 8:1 | A | 542091 | A |
| DO NOT SCALE DRAWING | | | SHEET 2 OF 2 |