

TOP VIEW

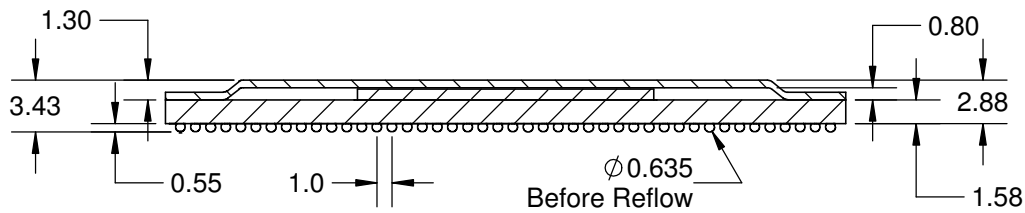

SECTION A-A

BALL VIEW

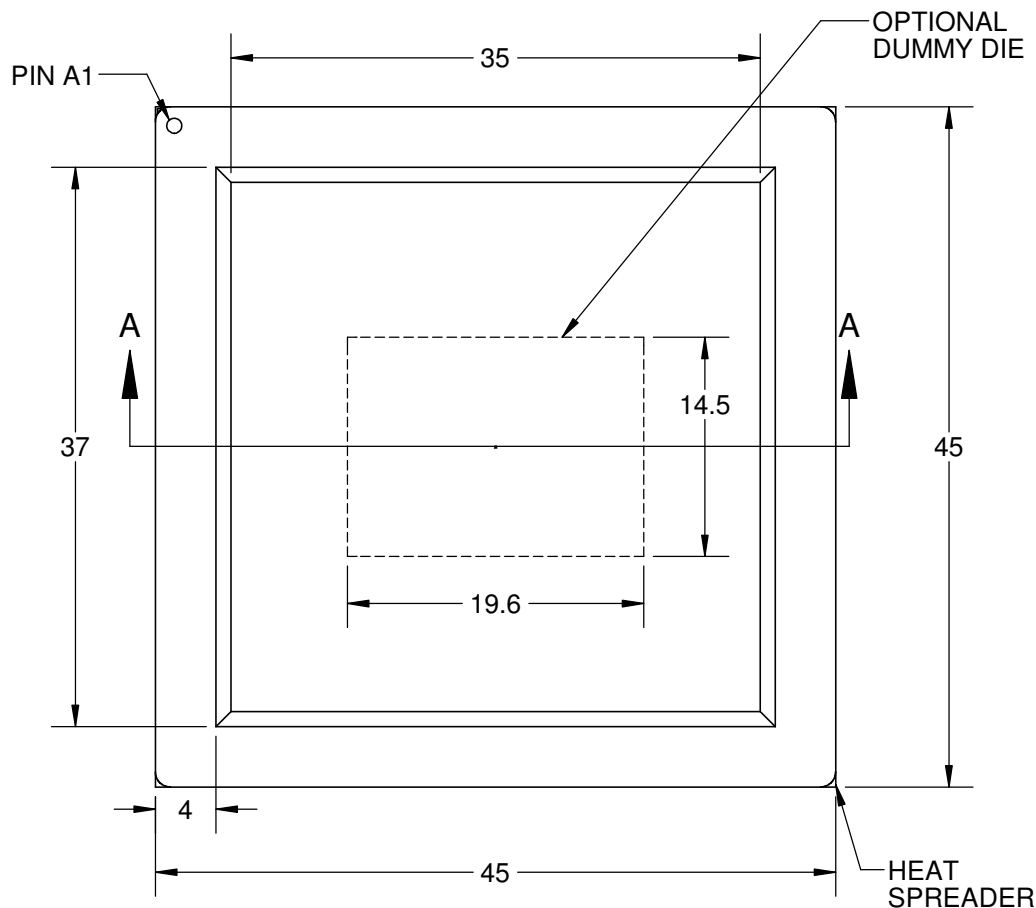
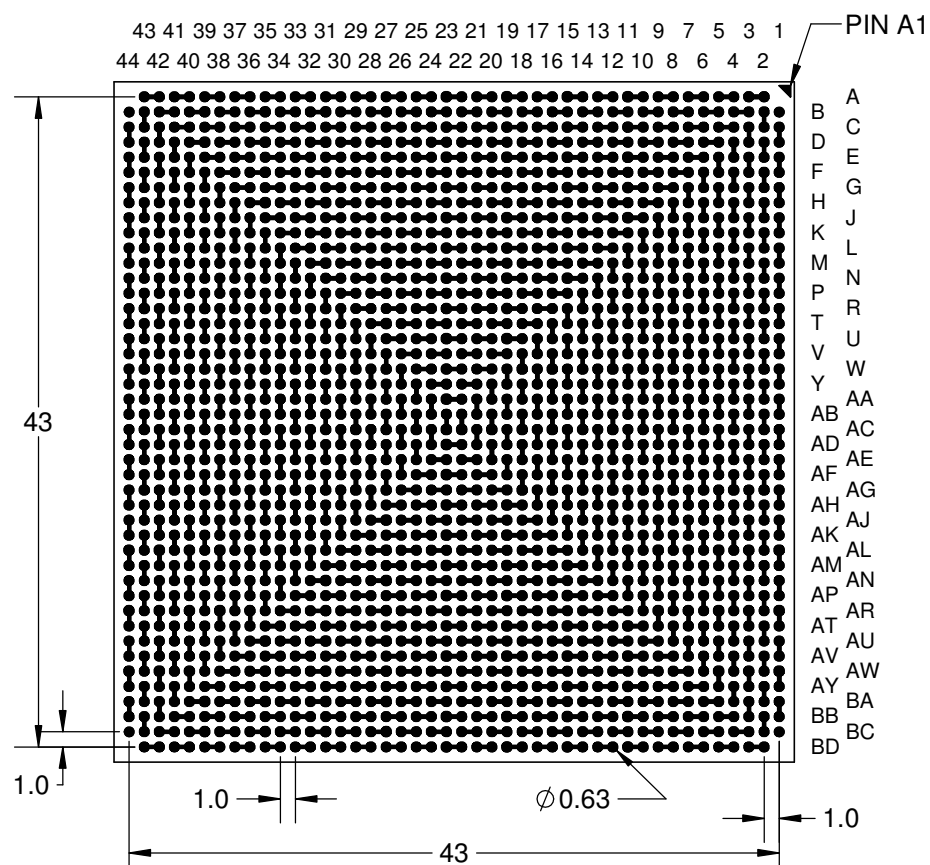

- Notes: (Unless Otherwise Specified).
- 1) ALL DIMENSIONS ARE IN MM.
 - 2) SOLDER BALL ALLOY: SEE PART NUMBER TABLE.
 - 3) BALL DIAMETER (BEFORE REFLOW): 0.635mm (25 MIL).
 - 4) SOLDER MASK DEFINED PAD OPENING: 0.508mm (20 MIL).
 - 5) PAD Cu DIAMETER: 0.635mm (25 MIL).
 - 6) SUBSTRATE MATERIAL: FR4 (ALTERNATE BT or Polyimide).
 - 7) DUMMY DIE IS OPTIONAL.
 - 8) DAISY CHAIN PATTERN (SEE PAGE 2).
 - 9) MSL-3 RECOMMENDED BAKING 24 HOURS @ 125°C TO REMOVE MOISTURE PRIOR SOLDERING TO PC BOARD.

PART NUMBER TABLE

PART NUMBER	BALL ALLOY	BALL ALLOY	RoHS	Si DIE
SBGA1932T1.0C-DC444D	Sn96.5/Ag3.0/Cu0.5	SAC305	YES	YES
SBGA1932T1.0-DC444D	Sn63/Pb37	Sn63	NO	YES

APPROVALS	DATE	TopLine®			
DRAWN T. Au	8/11/2017				
ENG M. Hart	8/11/2017	TITLE SBGA1932T1.0C-DC444D DAISY CHAIN DUMMY			
MFG		SCALE	SIZE	DRAWING NO.	REV
QA		2:1	A	514445	A
CUST		DO NOT SCALE DRAWING			SHEET 1 OF 10
REVISED					

BALL VIEW

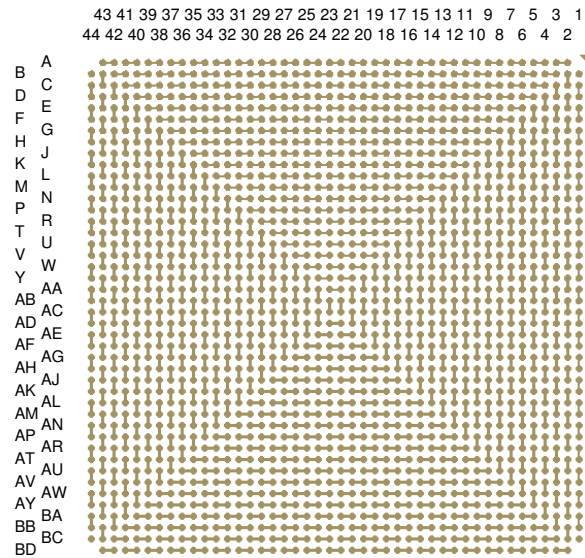

BOTTOM SIDE (TOP X-RAY VIEW)

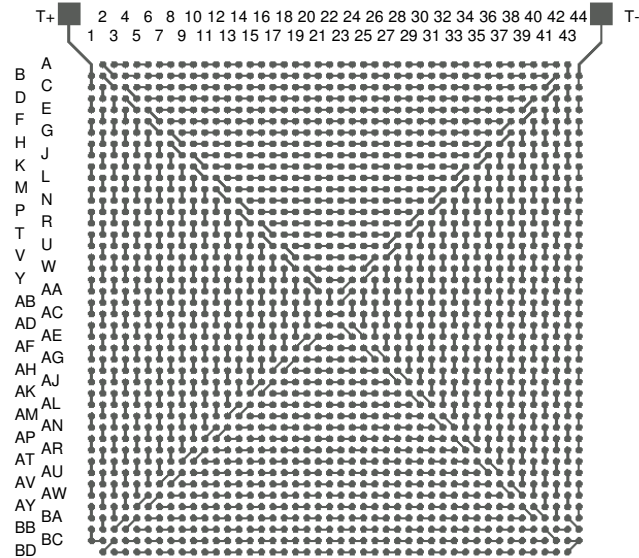
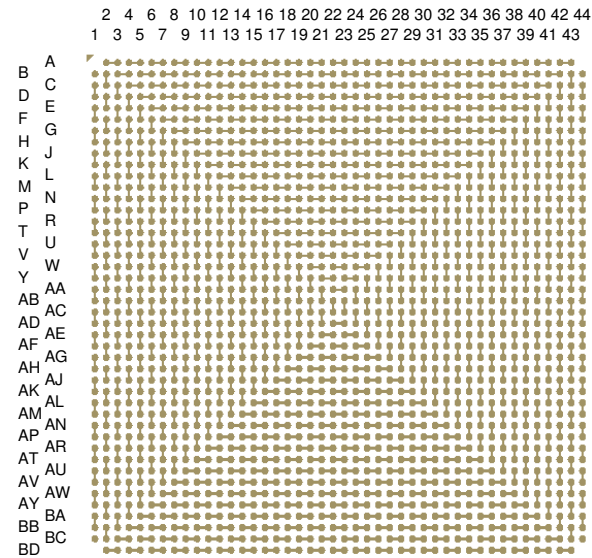

TEST VEHICLE BOARD

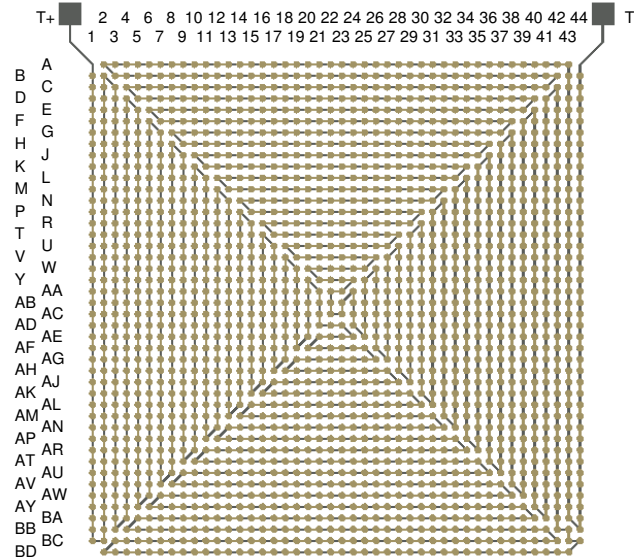

AFTER MOUNTING

Notes:

- 1) PCB BOARD DIMENSIONS ARE PRESENTD ONLY AS A GUIDELINE. DESIGNERS SHOULD USE THEIR OWN EXPERIENCE WHEN DESIGNING PCB.
- 2) PCB Cu BALL PAD DIAMETER 0.635mm [25 MIL].
- 3) PCB DAISY CHAIN TRACING LINE WIDTH 0.204mm [8 MIL].
- 4) SMD (SOLDER MASK DEFINED) PAD OPENING 0.508mm [20 MIL].

TopLine®

TITLE			
SBGA1932T1.0C-DC444D DAISY CHAIN DUMMY			
SCALE	SIZE	DRAWING NO.	REV
3:2	A	514445	A
DO NOT SCALE DRAWING			SHEET 2 OF 10

BALL VIEW

PIN A1

44 43 42 41 40 39 38 37 36 35 34 33 32 31 30 29 28 27 26 25 24 23 22 21 20 19 18 17 16 15 14 13 12 11 10 9 8 7 6 5 4 3 2 1

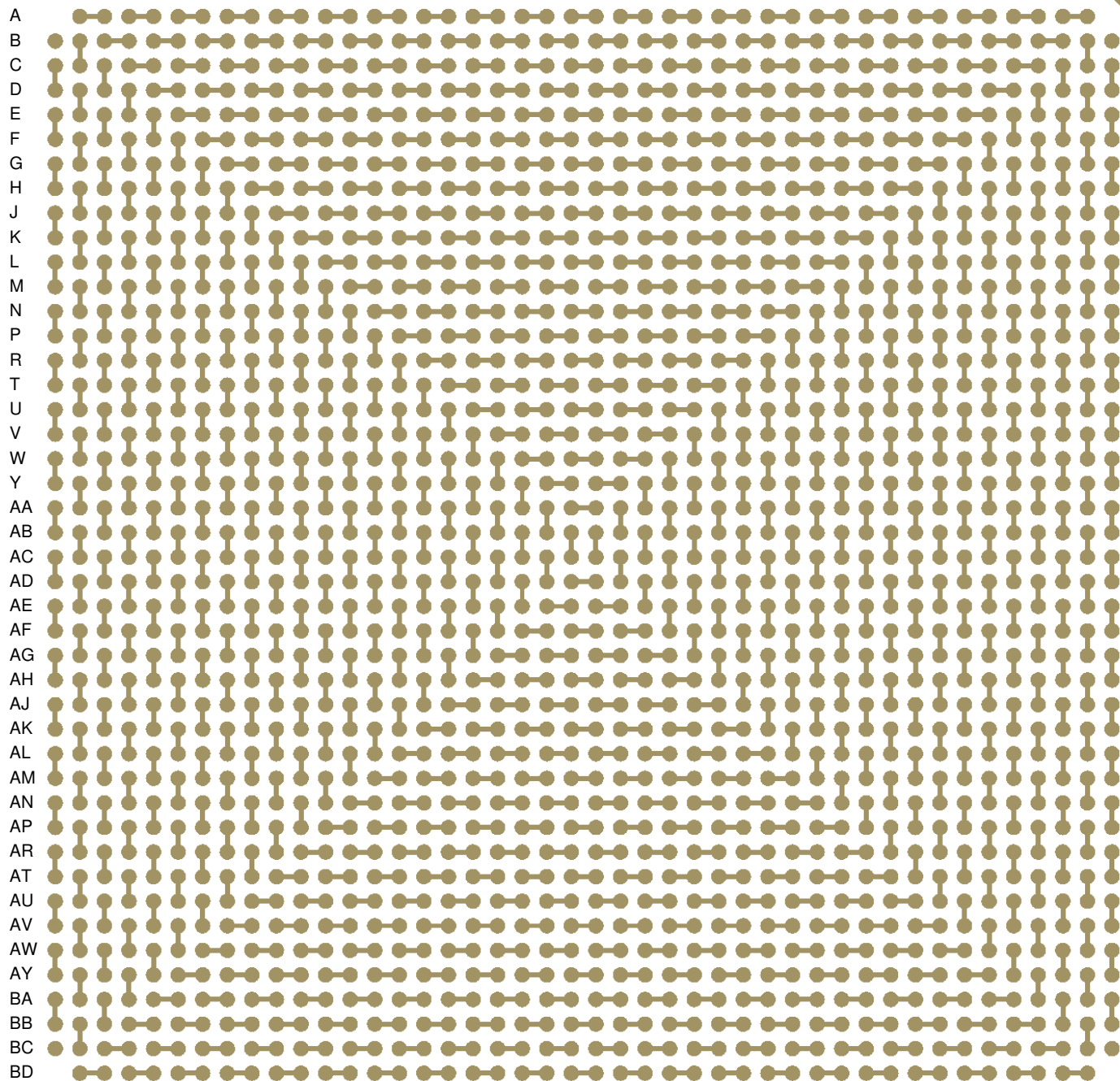

TopLine[®]			
TITLE		SBGA1932T1.0C-DC444D DAISY CHAIN DUMMY	
SCALE	SIZE	DRAWING NO.	REV
4:1	A	514445	A
DO NOT SCALE DRAWING			SHEET 3 OF 10

BOTTOM SIDE (TOP X-RAY VIEW)

PIN A1

1 2 3 4 5 6 7 8 9 10 11 12 13 14 15 16 17 18 19 20 21 22 23 24 25 26 27 28 29 30 31 32 33 34 35 36 37 38 39 40 41 42 43 44

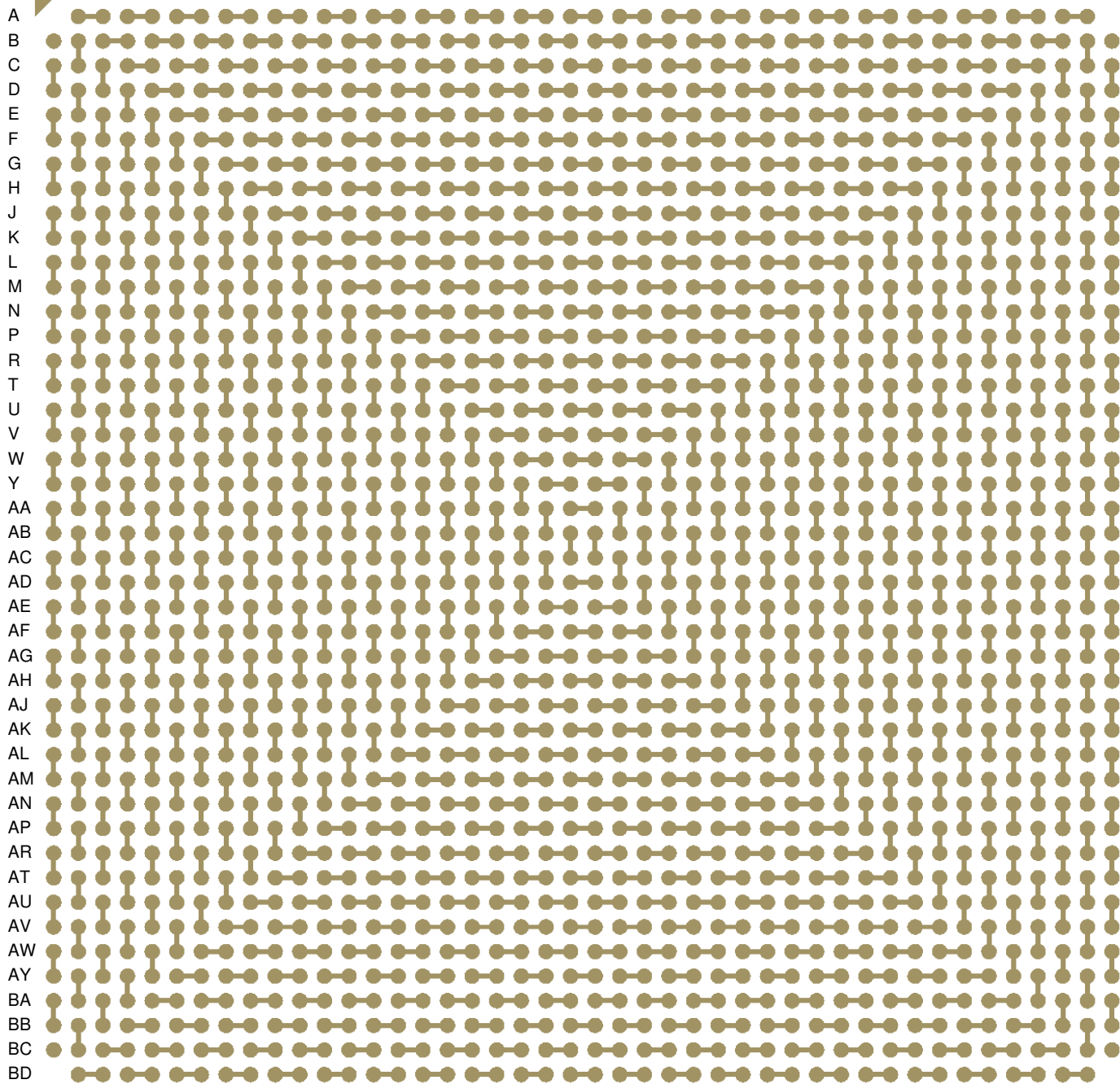

TITLE			
SBGA1932T1.0C-DC444D DAISY CHAIN DUMMY			
SCALE	SIZE	DRAWING NO.	REV
4:1	A	514445	A
DO NOT SCALE DRAWING			SHEET 4 OF 10

T+

TEST VEHICLE BOARD

T-

1 2 3 4 5 6 7 8 9 10 11 12 13 14 15 16 17 18 19 20 21 22 23 24 25 26 27 28 29 30 31 32 33 34 35 36 37 38 39 40 41 42 43 44

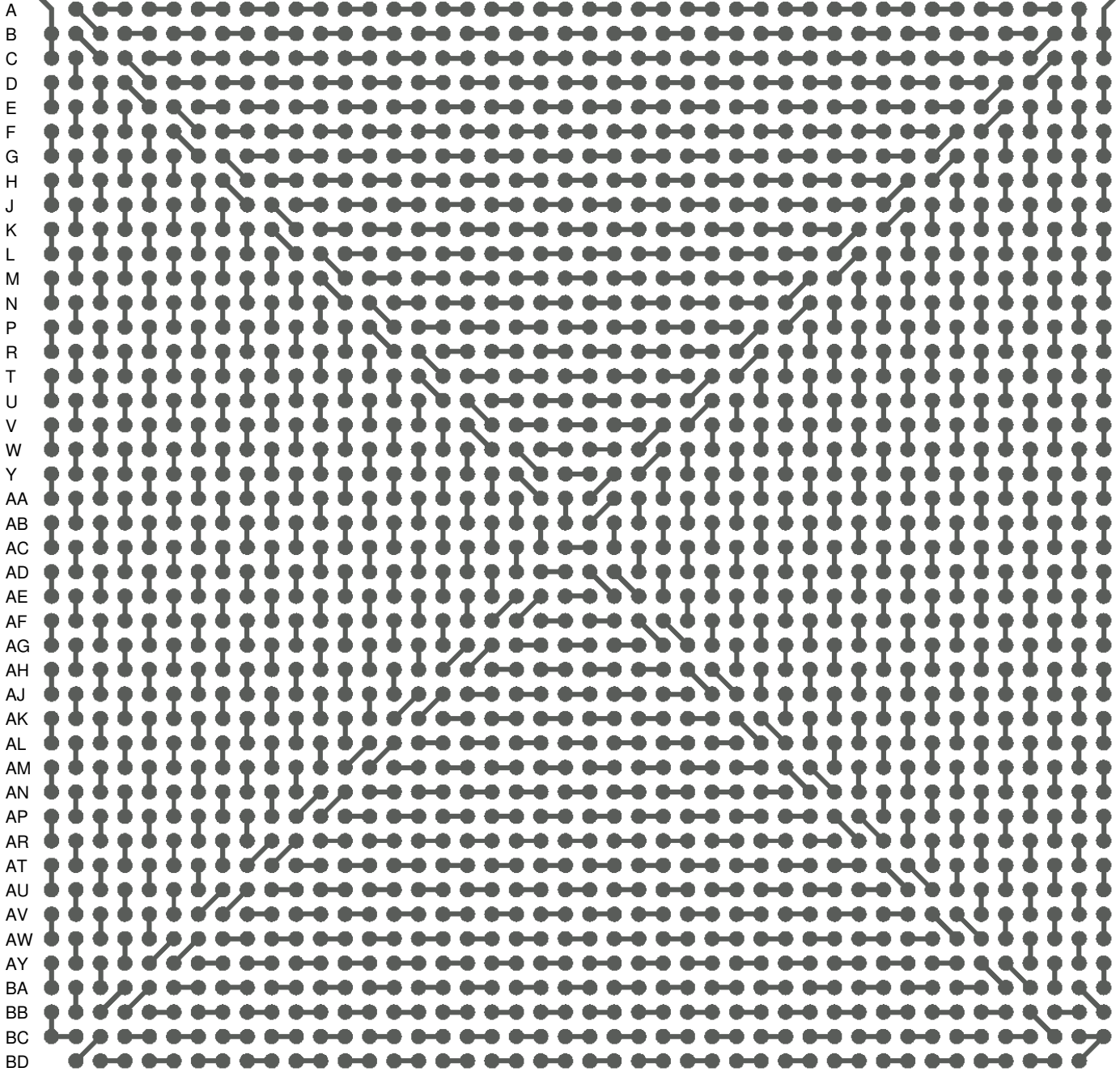

TITLE			
SBGA1932T1.0C-DC444D DAISY CHAIN DUMMY			
SCALE	SIZE	DRAWING NO.	REV
4:1	A	514445	A
DO NOT SCALE DRAWING			SHEET 5 OF 10

T+

T-

AFTER MOUNTING

1 2 3 4 5 6 7 8 9 10 11 12 13 14 15 16 17 18 19 20 21 22 23 24 25 26 27 28 29 30 31 32 33 34 35 36 37 38 39 40 41 42 43 44

A
B
C
D
E
F
G
H
J
K
L
M
N
P
R
T
U
V
W
Y
AA
AB
AC
AD
AE
AF
AG
AH
AJ
AK
AL
AM
AN
AP
AR
AT
AU
AV
AW
AY
BA
BB
BC
BD

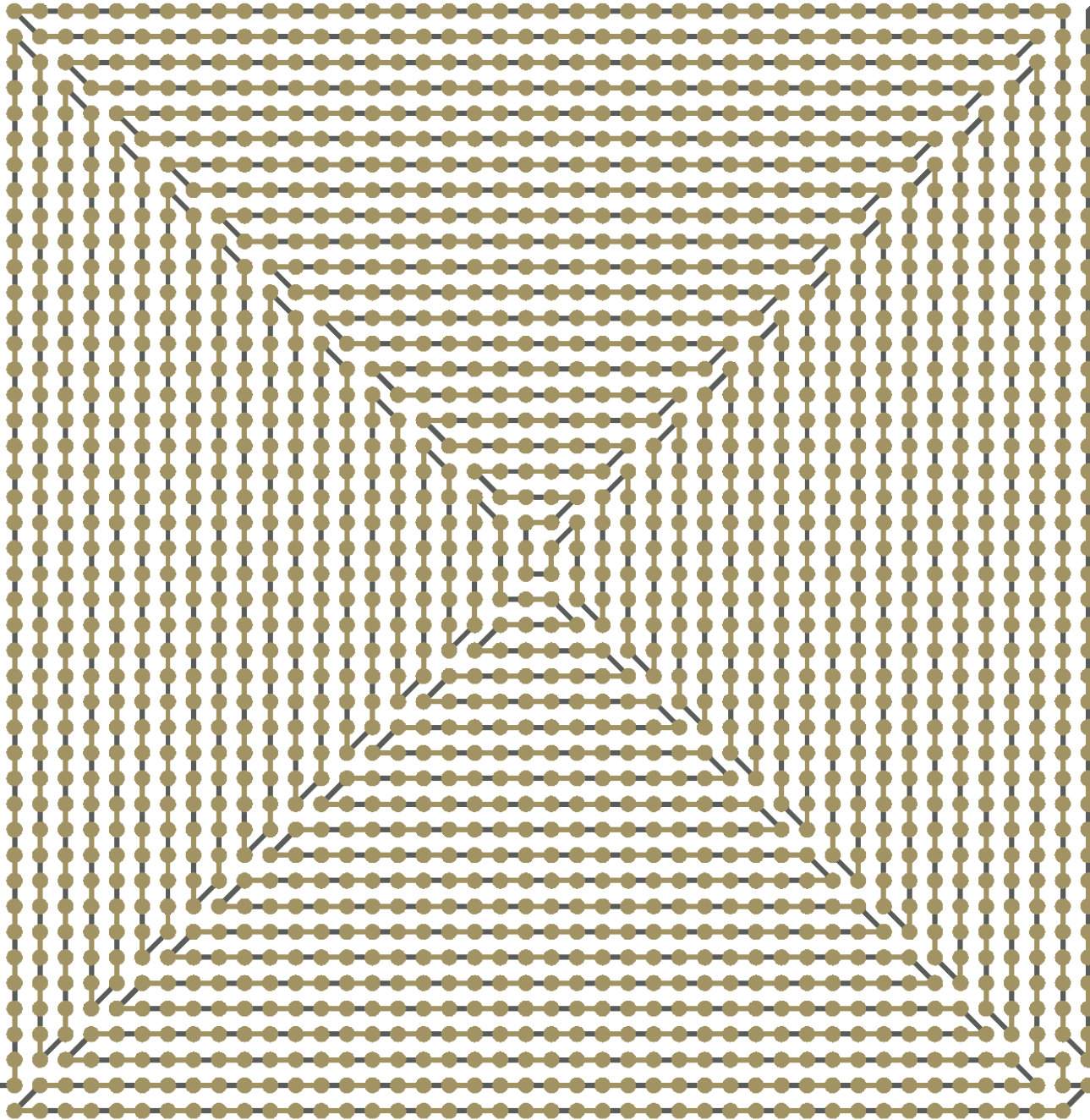

TITLE			
SBGA1932T1.0C-DC444D DAISY CHAIN DUMMY			
SCALE	SIZE	DRAWING NO.	REV
4:1	A	514445	A
DO NOT SCALE DRAWING			SHEET 6 OF 10

HEAT SPREADER

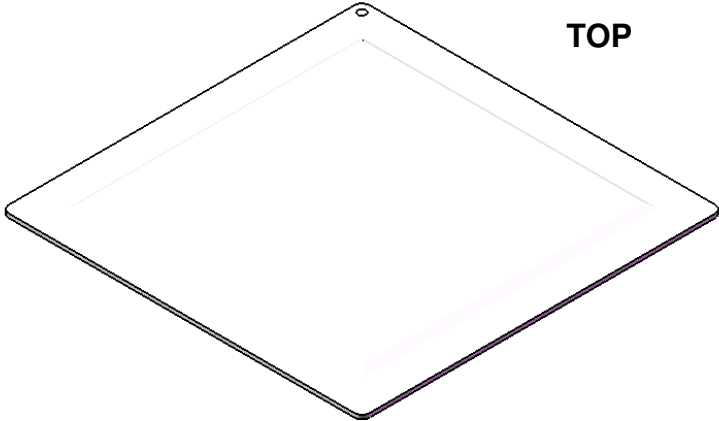
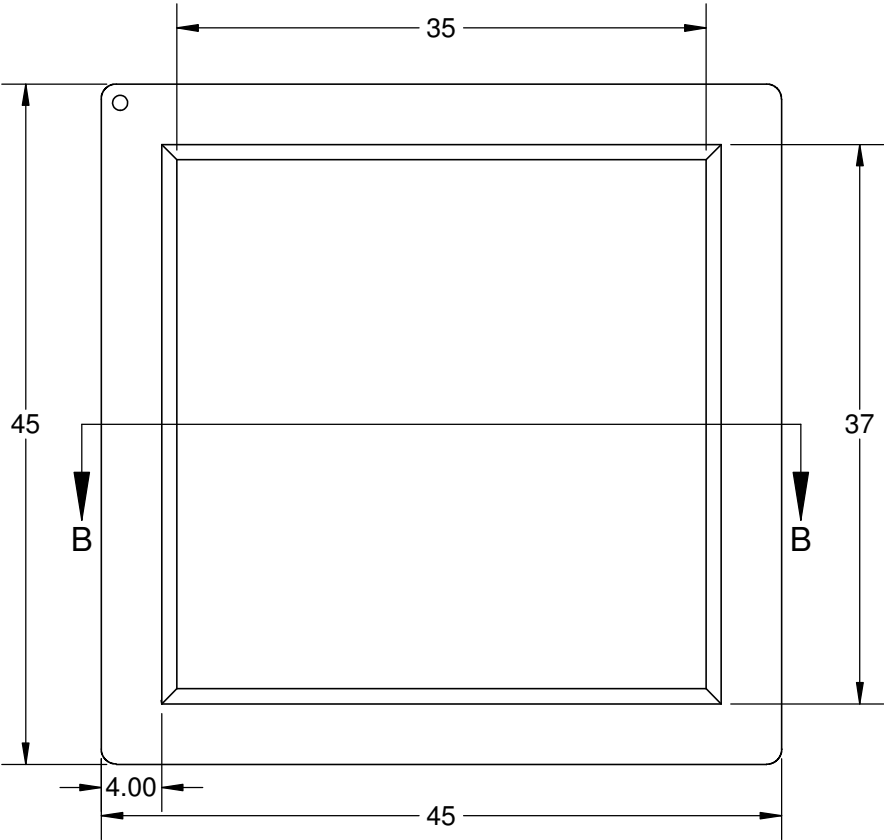

TOP

MODEL

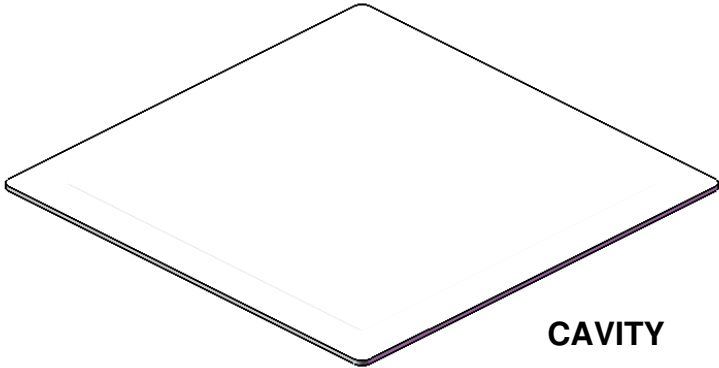

CAVITY

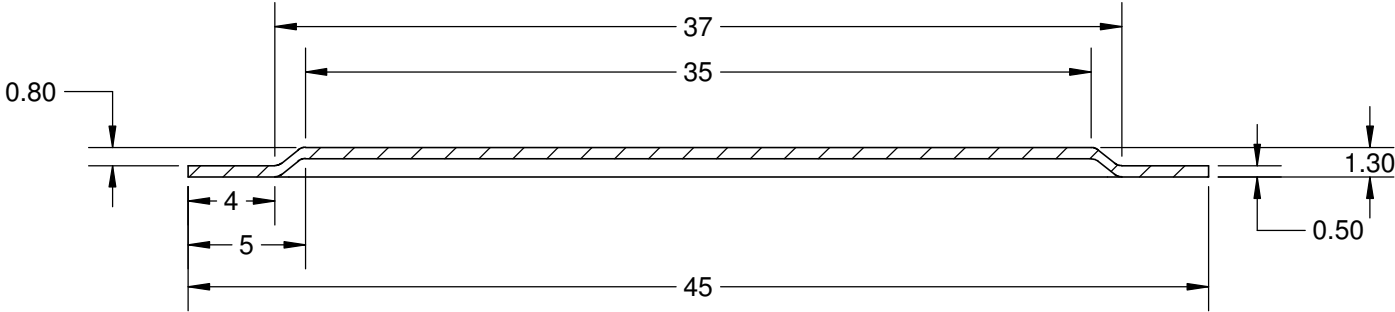

SECTION B-B
SCALE 3 : 1

TopLine®			
TITLE SBGA1932T1.0C-DC444D DAISY CHAIN DUMMY			
SCALE 2:1	SIZE A	DRAWING NO. 514445	REV A
DO NOT SCALE DRAWING			SHEET 7 OF 10

MODEL

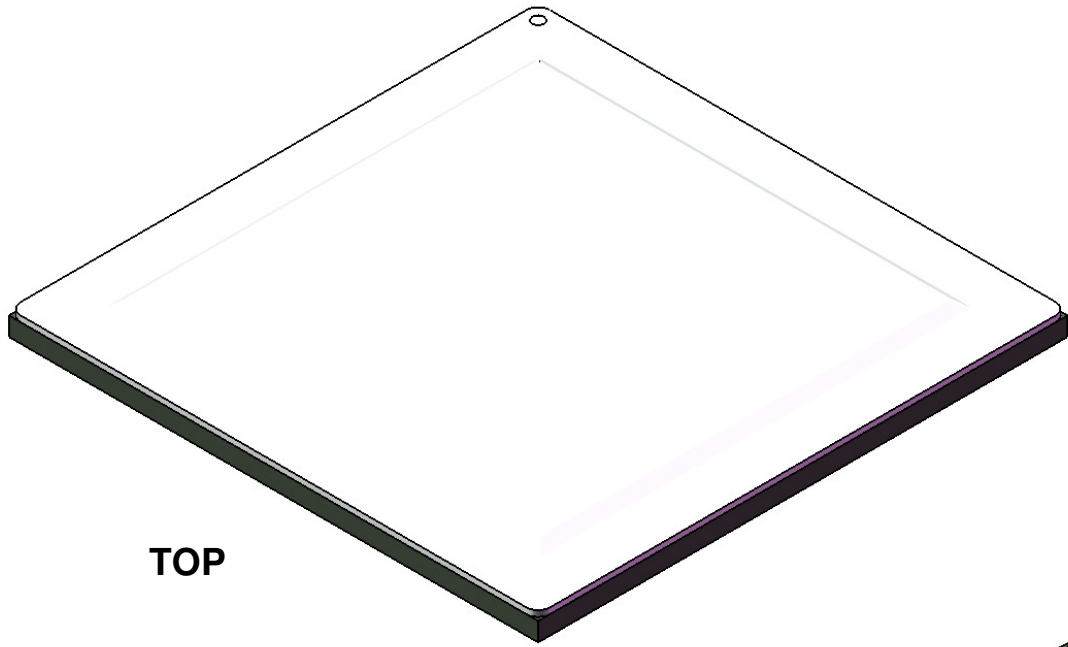

TOP

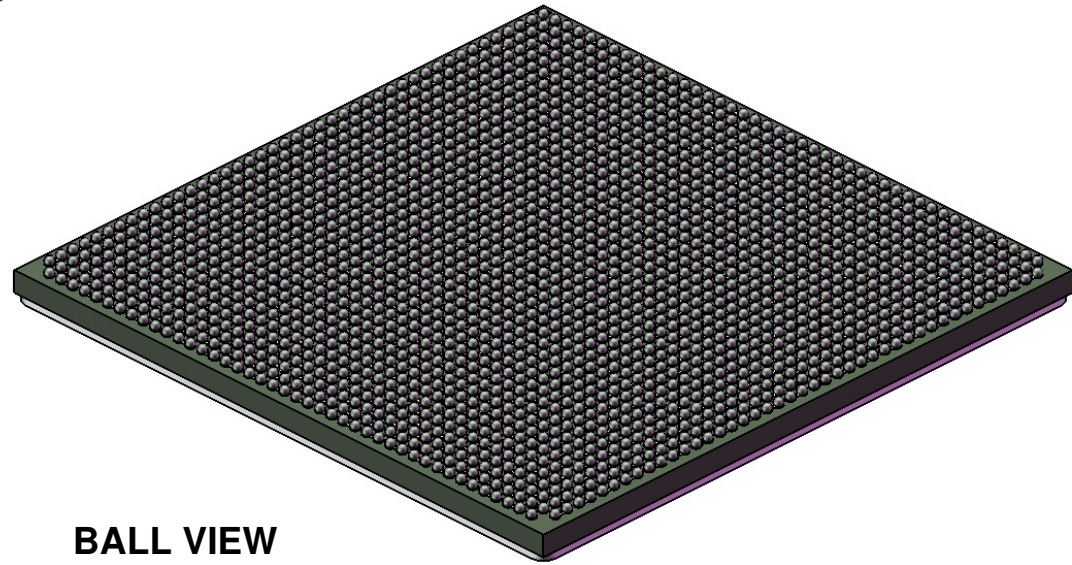

BALL VIEW

TopLine[®]

TITLE SBGA1932T1.0C-DC444D
DAISY CHAIN DUMMY

SCALE 2:1	SIZE A	DRAWING NO. 514445	REV A
--------------	-----------	-----------------------	----------

1 2 3 4 5 6 7 8 9 10 11 12 13 14 15 16 17 18 19 20 21 22 23 24 25 26 27 28 29 30 31 32 33 34 35 36 37 38 39 40 41 42 43 44

A
B
C
D
E
F
G
H
J
K
L
M
N
P
R
T
U
V
W
Y
AA
AB
AC
AD
AE
AF
AG
AH
AJ
AK
AL
AM
AN
AP
AR
AT
AU
AV
AW
AY
BA
BB
BC
BD

TOP LAYER - LAYER 1

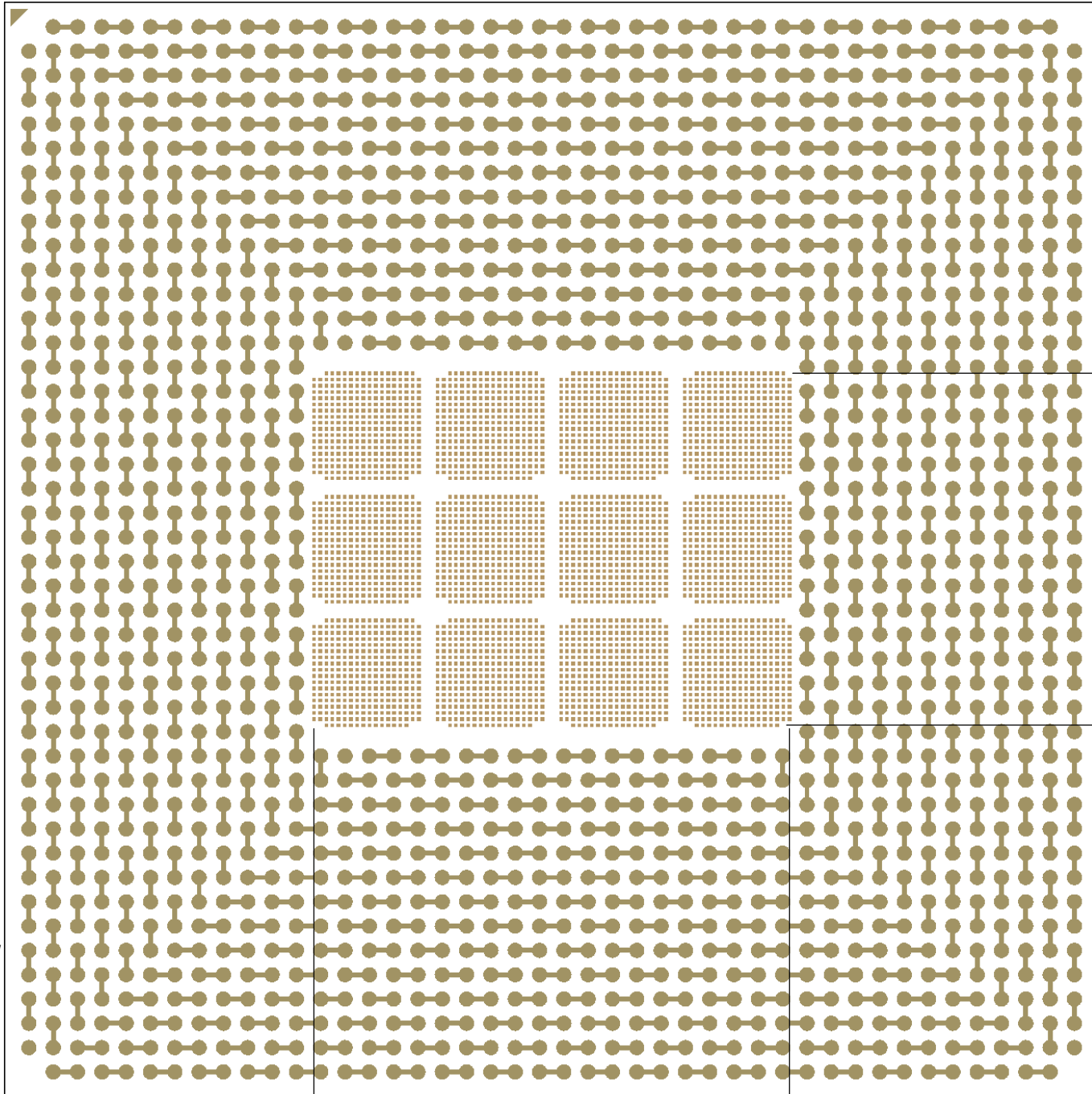

15.42

19.56
45

TopLine[®]			
TITLE		SBGA1932T1.0C-DC444D DAISY CHAIN DUMMY	
SCALE	SIZE	DRAWING NO.	REV
4:1	A	514445	A
DO NOT SCALE DRAWING			SHEET 9 OF 10

44 43 42 41 40 39 38 37 36 35 34 33 32 31 30 29 28 27 26 25 24 23 22 21 20 19 18 17 16 15 14 13 12 11 10 9 8 7 6 5 4 3 2 1

A
B
C
D
E
F
G
H
J
K
L
M
N
P
R
T
U
V
W
Y
AA
AB
AC
AD
AE
AF
AG
AH
AJ
AK
AL
AM
AN
AP
AR
AT
AU
AV
AW
AY
BA
BB
BC
BD

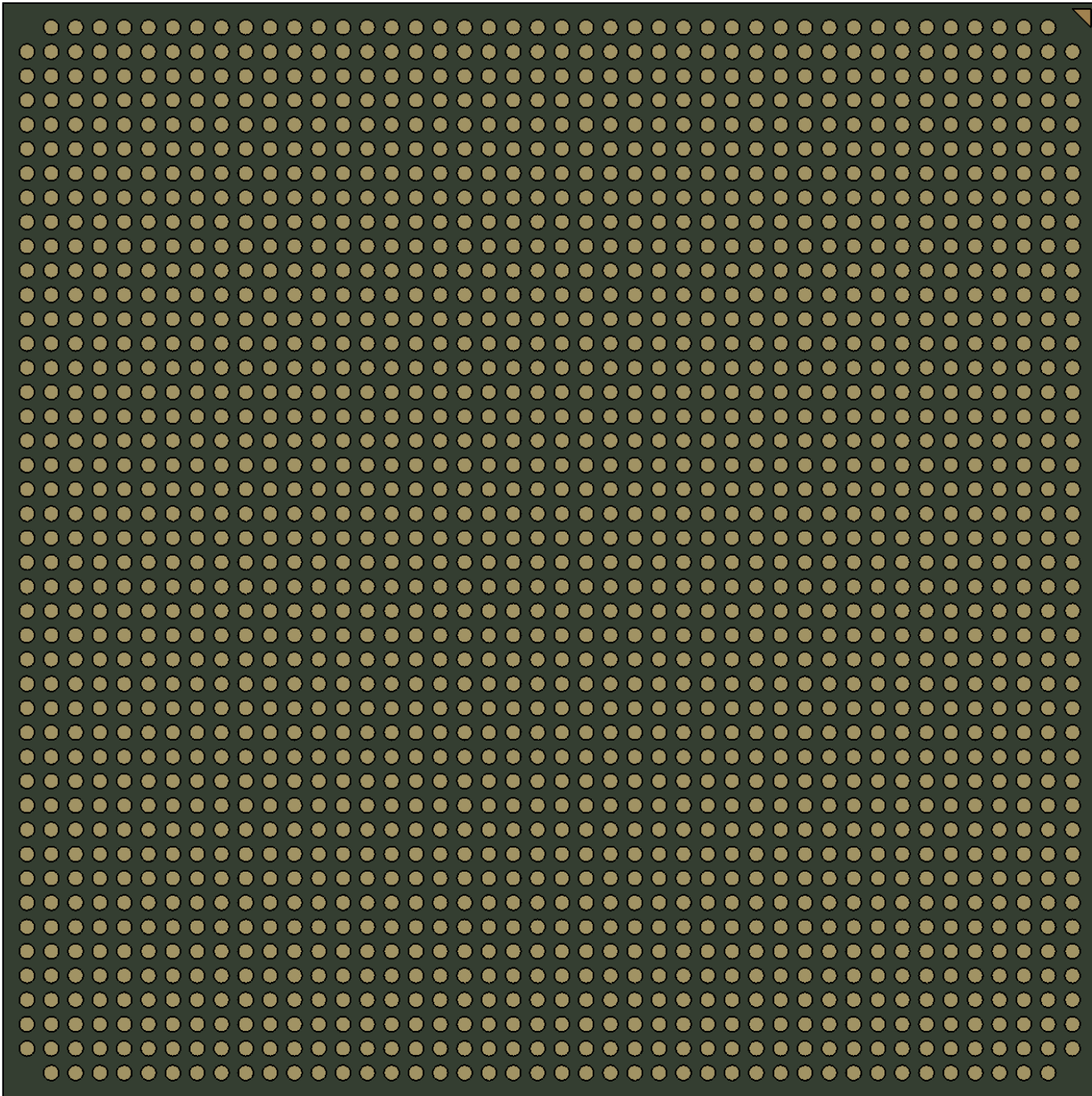

BOTTOM SOLDER MASK (RIGHT READING)

TopLine[®]			
TITLE		SBGA1932T1.0C-DC444D DAISY CHAIN DUMMY	
SCALE	SIZE	DRAWING NO.	REV
4:1	A	514445	A
DO NOT SCALE DRAWING			SHEET 10 OF 10