

### TOP VIEW

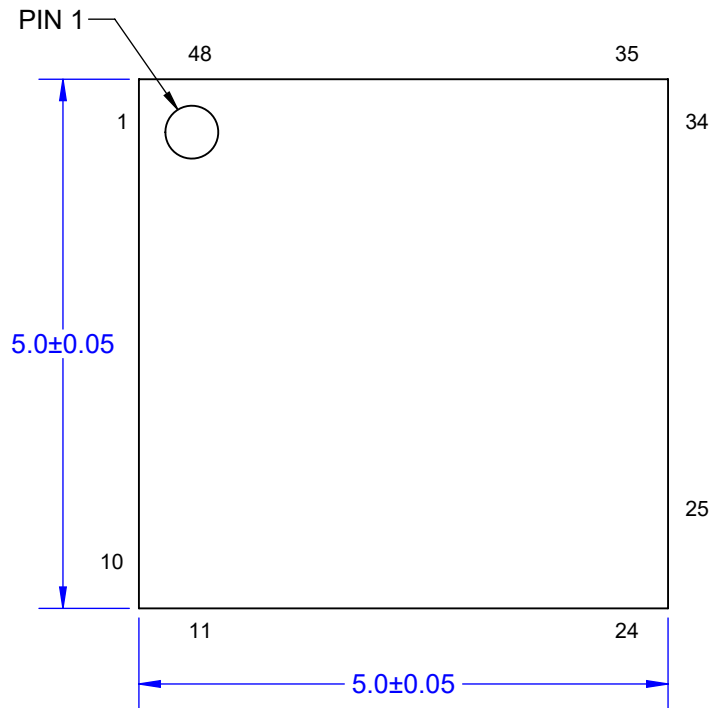

### SIDE VIEW

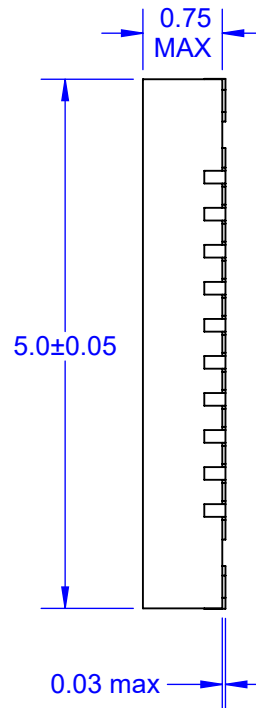

### BOTTOM VIEW

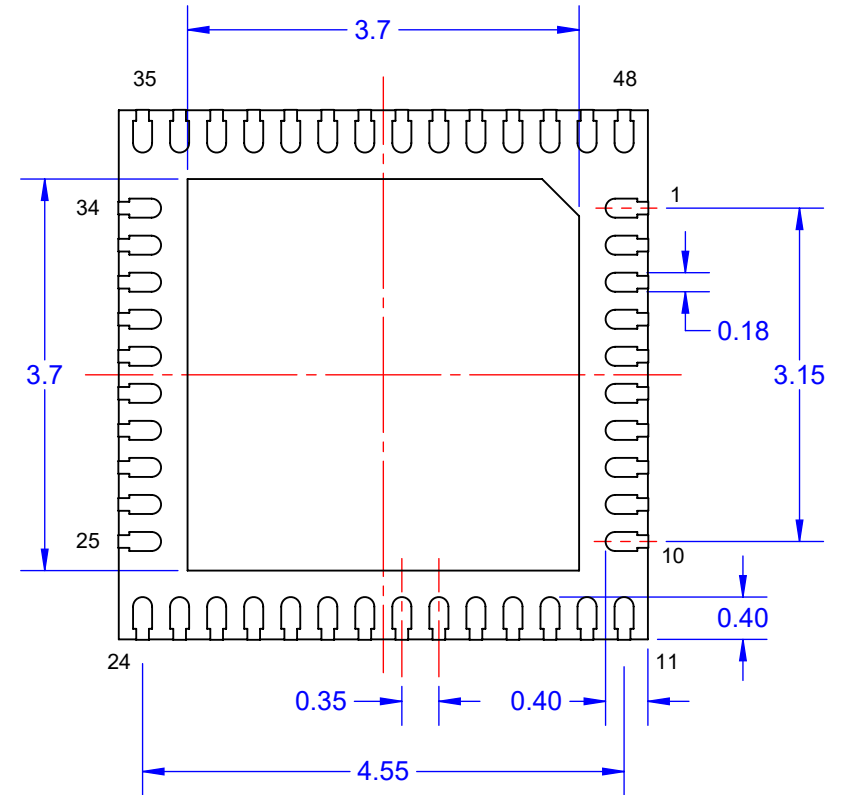

### MODEL

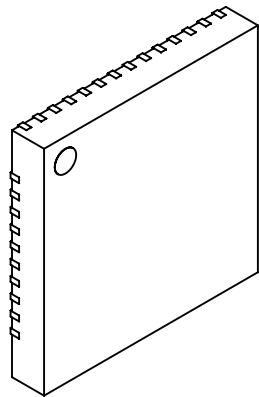

TOP

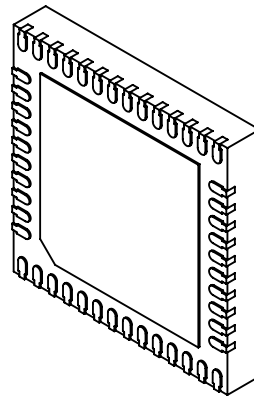

BOTTOM

Notes: (Unless Otherwise Specified).

- 1) BODY: PLASTIC, SEMICONDUCTOR GRADE.
- 2) LEAD FRAME: COPPER, C-194 F/H.
- 3) LEAD FRAME PLATING: Sn100.
- 4) FRAME THICKNESS: 0.203mm.
- 5) DIE PAD: 3.7 x 3.7mm EXPOSED BOTTOM.
- 6) JEDEC OUTLINE: MO-220.
- 7) DIMENSIONS: mm.

APPROVALS	DATE	<b>TopLine®</b>			
DRAWN T. Au	11/10/2023				
ENG M. Hart	11/10/2023	TITLE 48-LEAD 5mm P0.35mm QFN DAISY CHAIN			
MFG		SCALE	SIZE	DRAWING NO.	REV
QA		14:1	A	434800	B
CUST		DO NOT SCALE DRAWING			SHEET 1 OF 5
REVISED					

# PAD PATTERN

## TOP VIEW

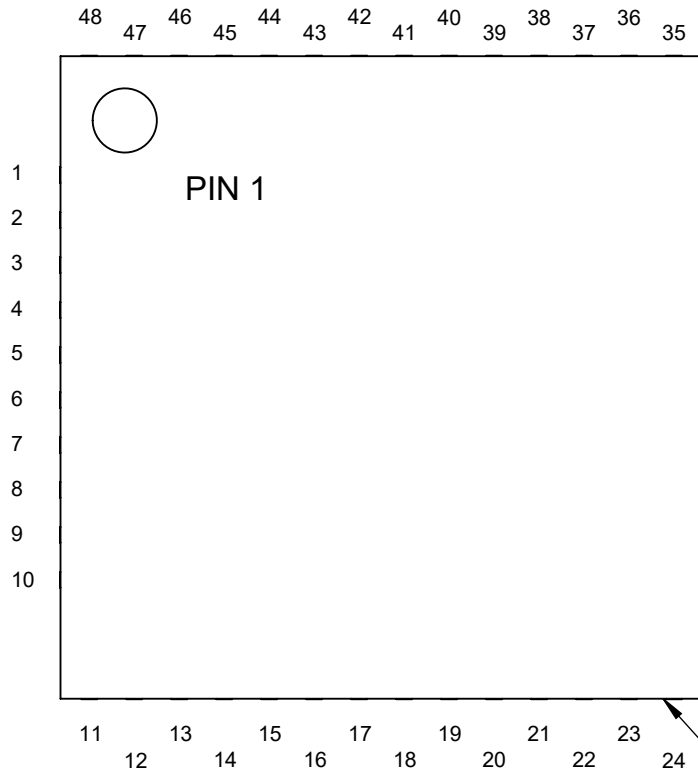

## SIDE VIEW

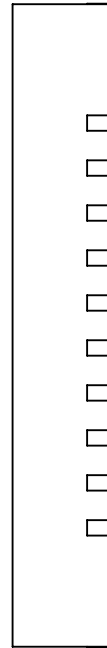

## BOTTOM VIEW

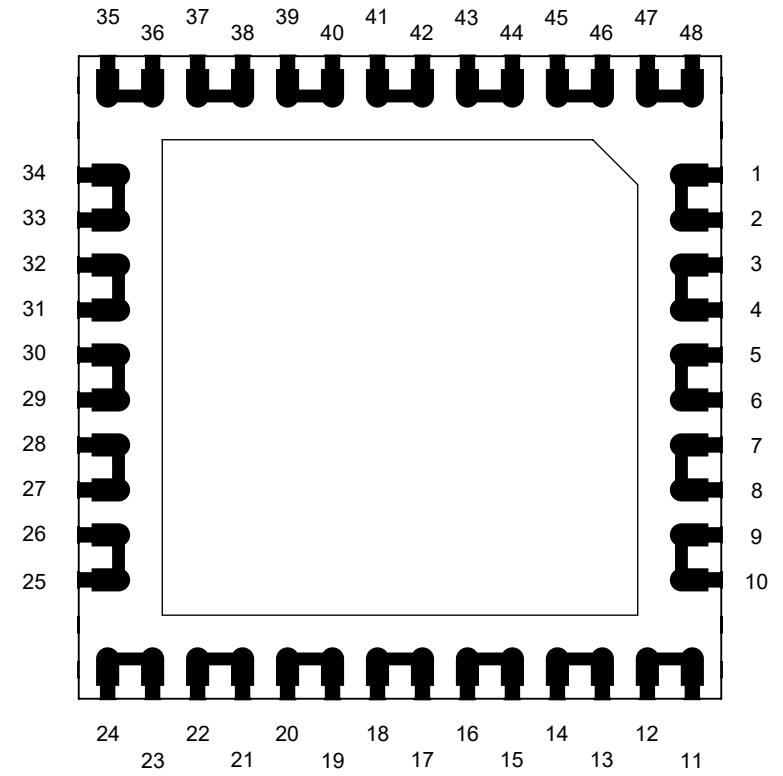

TOP SIDE  
ENCAPSULATION

NOTE:  
1. PACKAGE DAISY CHAIN BY WIRE BONDING TO INTERNAL BOND PADS

<b>TopLine®</b>			
TITLE 48-LEAD 5mm P0.35mm QFN DAISY CHAIN			
SCALE 17:1	SIZE A	DRAWING NO. 434800	REV B
DO NOT SCALE DRAWING			SHEET 2 OF 5

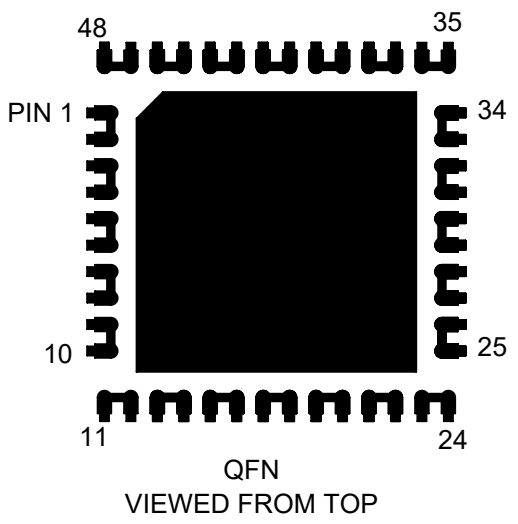
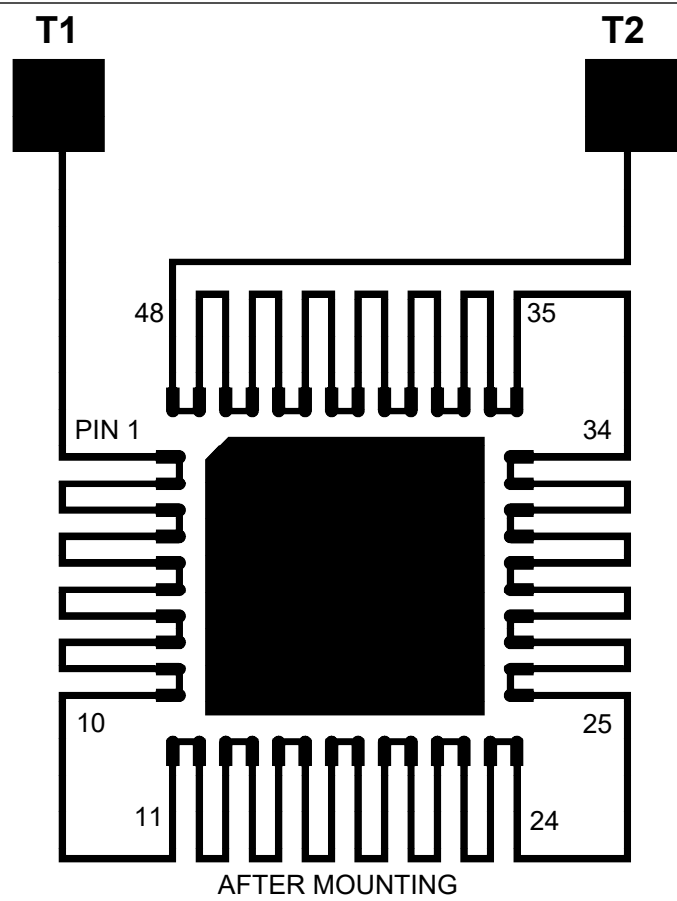
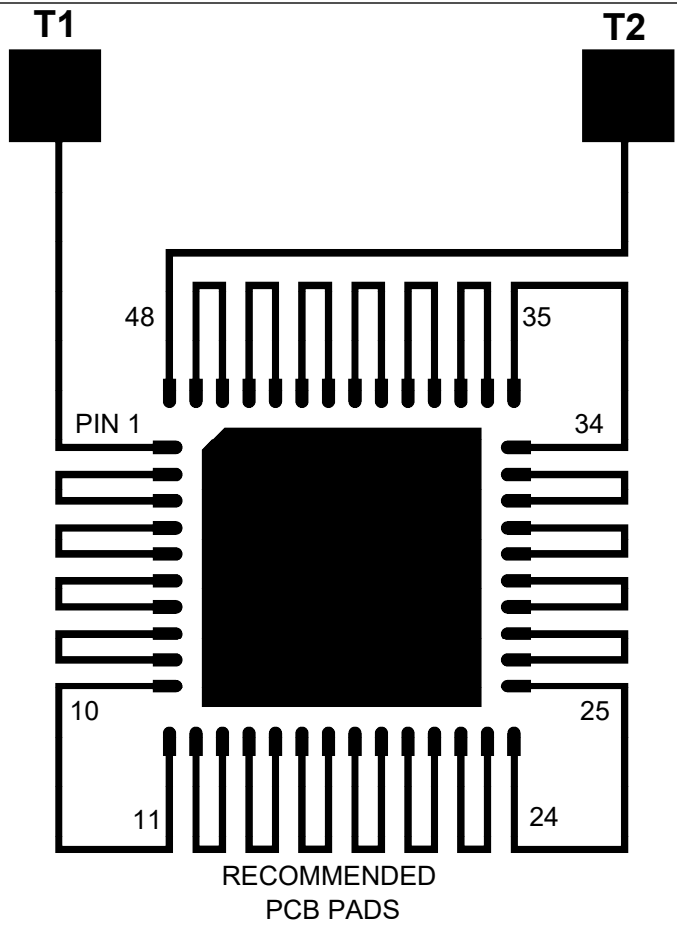

DAISY CHAIN NET LIST		
PINS	PINS	PINS
1 ~ 2	3 ~ 4	5 ~ 6
7 ~ 8	9 ~ 10	11 ~ 12
13 ~ 14	15 ~ 16	17 ~ 18
19 ~ 20	21 ~ 22	23 ~ 24
25 ~ 26	27 ~ 28	29 ~ 30
31 ~ 32	33 ~ 34	35 ~ 36
37 ~ 38	39 ~ 40	41 ~ 42
43 ~ 44	45 ~ 46	47 ~ 48

<b>TopLine®</b>			
TITLE 48-LEAD 5mm P0.35mm QFN DAISY CHAIN			
SCALE 10:1	SIZE A	DRAWING NO. 434800	REV B
DO NOT SCALE DRAWING			SHEET 3 OF 5

# PC BOARD LAYOUT DIMENSIONS IN MM VIEW FROM TOP

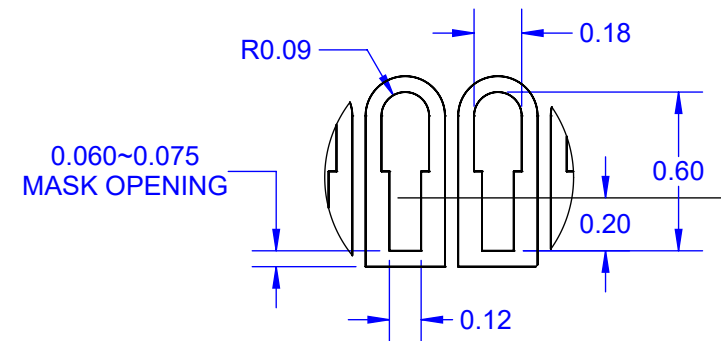
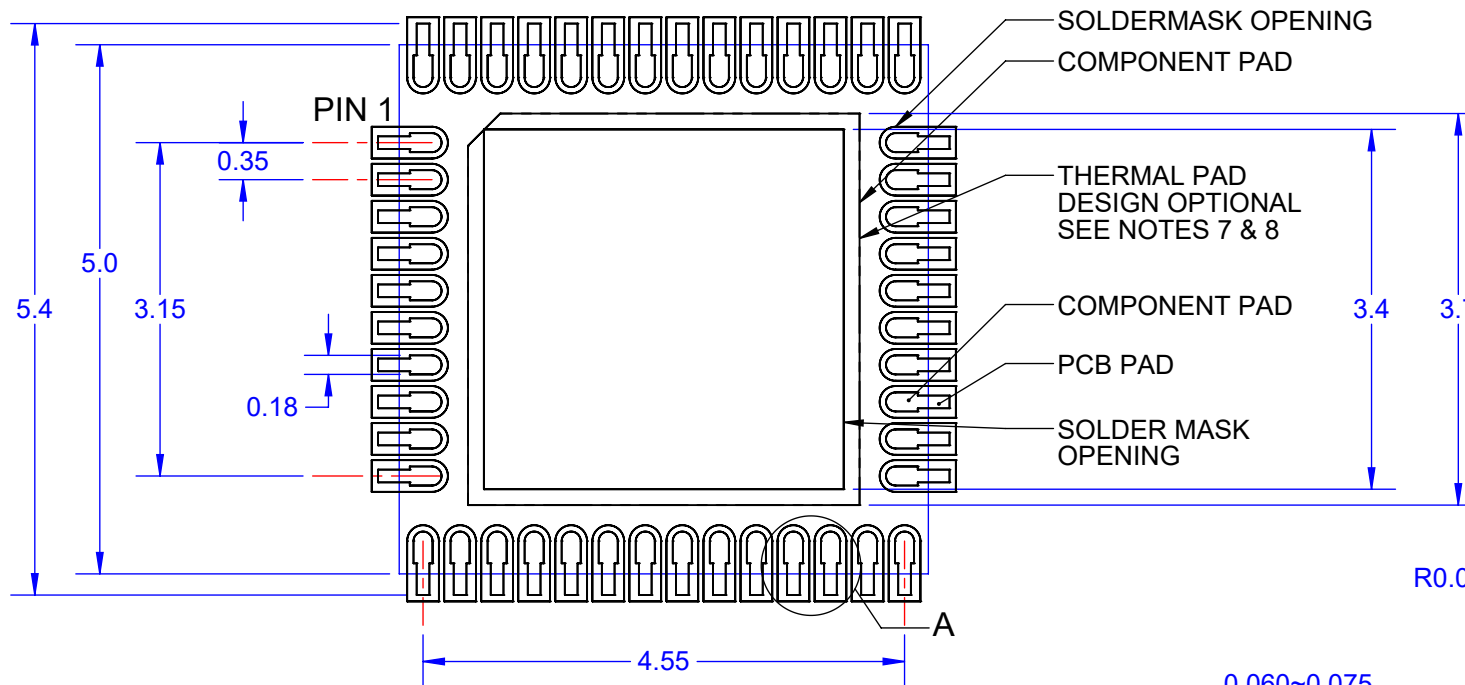

DETAIL A  
SCALE 35 : 1

Notes: (Unless Otherwise Specified).

- 1) DIMENSIONS ARE PRESENTED ONLY AS A GUIDELINE. DESIGNERS SHOULD USE THEIR OWN KNOWLEDGE BASE WHEN DESIGNING THE PCB.
- 2) SURROUND EACH SIDE OF I/O PERIMETER PADS WITH 0.060~0.075 mm (NSMD) SOLDER MASK OPENING (2.4~3.0mils) OPTIONALLY OK TO USE RECTANGLE (NSMD) MASK OPENING AROUND I/O PADS.
- 3) ROUNDED PCB LAND PADS REDUCE SOLDER BRIDGING. PAD CHAMFER ANGLE MAY VARY.
- 4) PCB LANDS SHOULD BE 0.2mm LONGER THAN THE PACKAGE I/O PADS.
- 5) THE WIDTH OF PERIMETER PCB PADS SHOULD MATCH (1:1) THE WIDTH OF THE PACKAGE PADS.
- 6) REFER TO INDUSTRY REFERENCES SUCH AS IPC-SM-782 FOR PCB LAND PATTERN DESIGN.
- 7) THERMAL GROUND PADS MAY BE CHANGED TO SUIT THE REQUIREMENTS OF THE DESIGNER.
  - A) MAKE COPPER THERMAL PAD AS LARGE AS POSSIBLE.
  - B) DRILL MULTIPLE THERMAL VIAS 0.25~0.33mm DIAMETER USING 0.8~1.2mm PITCH GRID.
  - C) PLATE THERMAL VIA BARRELS WITH 1-OUNCE COPPER (18 $\mu$ m).
  - D) TENT (COVER) THERMAL VIAS WITH SOLDER MASK 0.1mm LARGER THAN THE VIA DIAMETER.
- 8) STENCIL DESIGN MAY BE CHANGED TO SUIT THE REQUIREMENTS OF THE DESIGNER.
  - A) LASER CUT STENCIL 0.125mm (5mil) THICK. APERTURE SIZE-TO-LAND RATIO OF 1:1.
  - B) THE SOLDER PASTE OPENING IN THE THERMAL PAD AREA SHOULD BE A MATRIX ARRAY OF SMALLER APERTURES INSTEAD OF ONE LARGE APERTURE TO CONTROL PASTE AMOUNTS.
  - C) APPLY 50% TO 80% SOLDER PASTE COVERAGE IN THE PAD AREA.

<b>TopLine®</b>			
TITLE 48-LEAD 5mm P0.35mm QFN DAISY CHAIN			
SCALE 18:1	SIZE A	DRAWING NO. 434800	REV B
DO NOT SCALE DRAWING			SHEET 4 OF 5

## PART NUMBERING SYSTEM

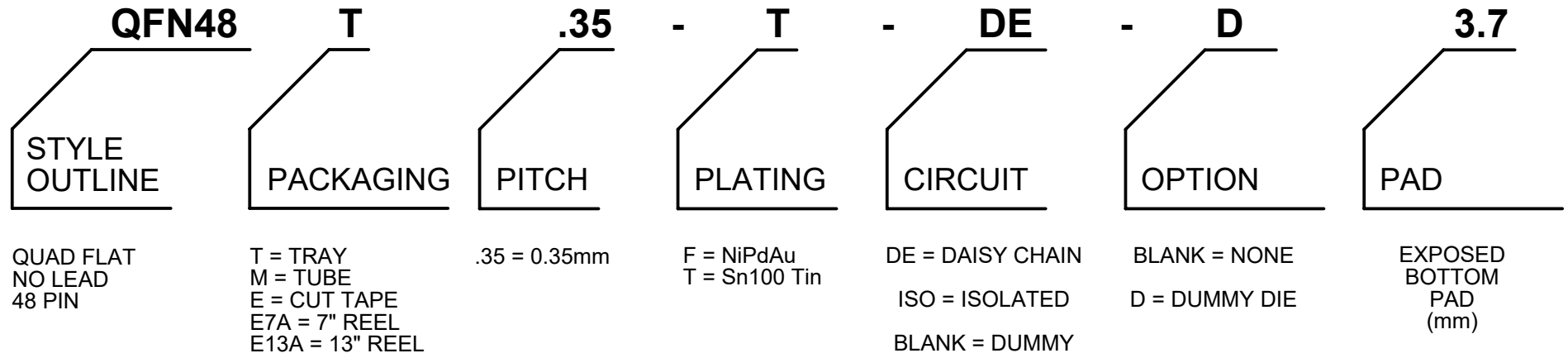

PART NUMBER	CIRCUIT	PACKAGING	RoHS Pb-FREE	PLATING	DUMMY DIE
QFN48T.35-T-DE-D3.7	DAISY CHAIN	JEDEC TRAY	YES	Sn100	YES
QFN48E.35-T-DE-D3.7	DAISY CHAIN	TAPE	YES	Sn100	YES
QFN48T.35-T-ISO	ISOLATED	JEDEC TRAY	YES	Sn100	NO

OTHER PART NUMBER COMBINATIONS AVAILABLE. CONTACT TOPLINE.

<b>TopLine®</b>			
TITLE 48-LEAD 5mm P0.35mm QFN DAISY CHAIN			
SCALE NONE	SIZE A	DRAWING NO. 434800	REV B
DO NOT SCALE DRAWING			SHEET 5 OF 5