

WHITE AND BLACK CHIPS WITHOUT METALLIZATION

TOP VIEW

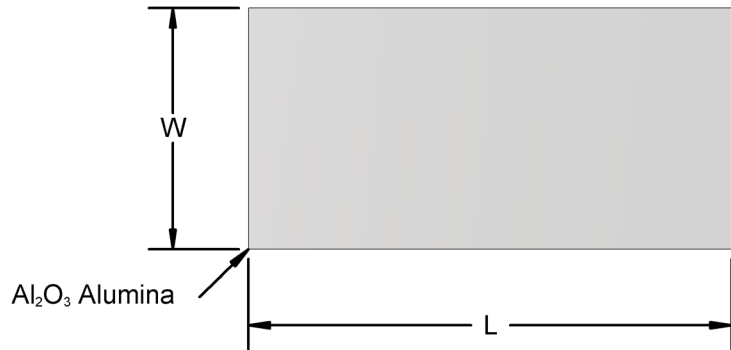

SIDE VIEW

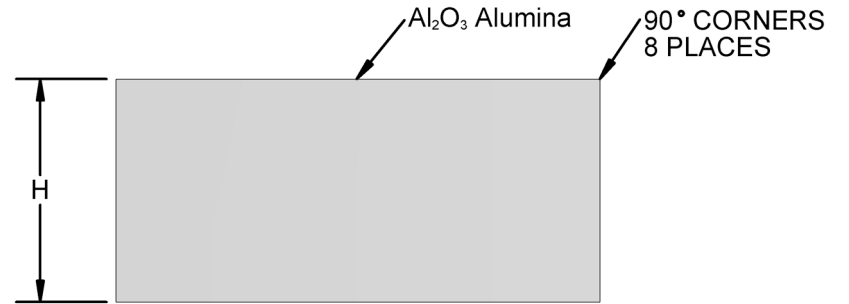

NOTES:

1. DIMENSION IN mm EXCEPT AS NOTED.
2. METALLIZATION: NONE.
3. Pb-FREE AND HALOGEN FREE.
4. COLORS: WHITE and BLACK.

PART NUMBER TABLE

SIZE CODE	COLOR	PART SERIES	SIZE (MM)				TOLERANCE	OUTLINE DRAWING
			L LENGTH	W WIDTH	H HEIGHT			
0603	WHITE	SCC0603P7A-WHITE	1.50	0.80	0.74	±0.076	060310	
0603	BLACK	SCC0603P7A-BLACK	1.50	0.80	0.74	±0.076	060311	

MODELS

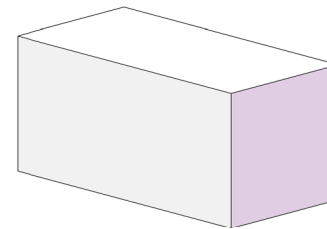

WHITE

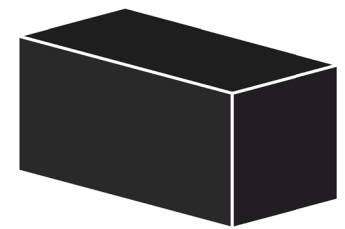

BLACK

APPROVALS	DATE	TopLine®			
DRAWN T. Au	7/9/2018				
ENG M. Hart	7/9/2018	TITLE SCC0603 UNTERMINATED CHIPS			
MFG		SCALE	SIZE	DRAWING NO.	REV
QA		40:1	A	060310	A
CUST		DO NOT SCALE DRAWING			SHEET 1 OF 2
REVISED					

W8P4 CARRIER TAPE DIMENSION

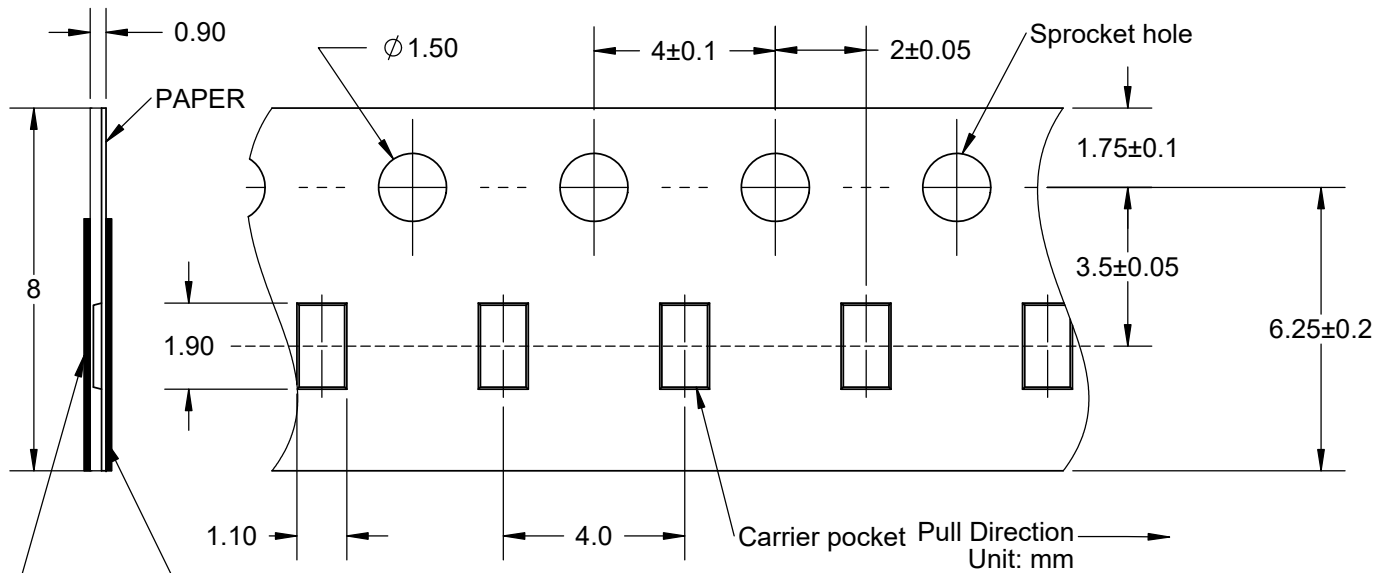

PART NUMBER SYSTEM

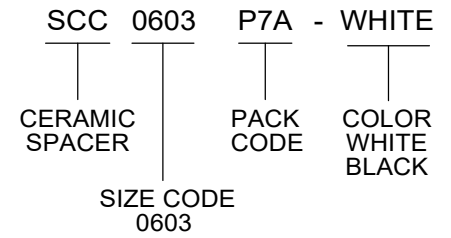

Bottom Tape
Cover Tape

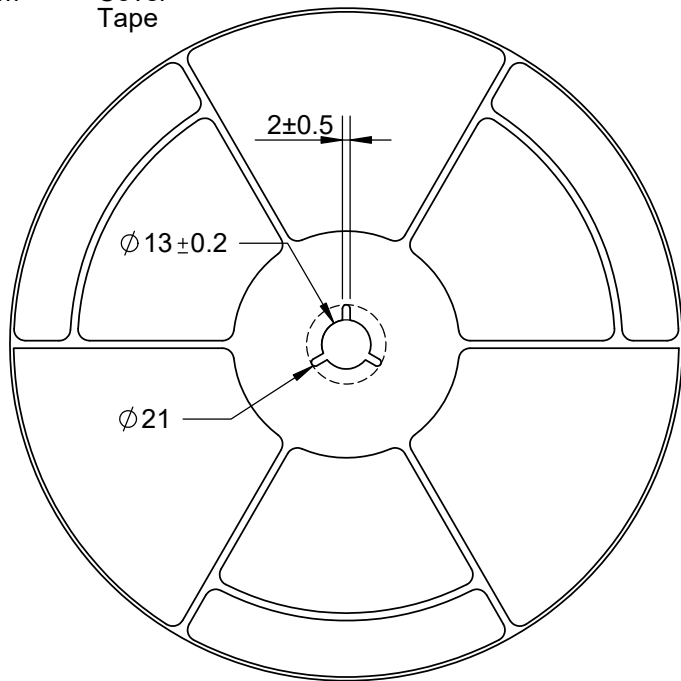

REEL DIMENSIONS

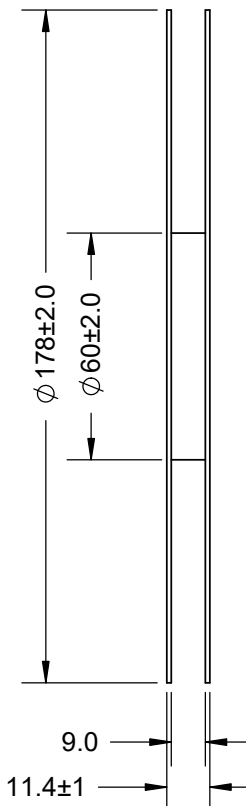

PACK CODE			
CODE	QTY	PACKAGE	TAPE
P7A	4,000	REEL	PAPER
P4A	1,000	REEL	PAPER

APPROVALS	DATE				
DRAWN T. Au	7/9/2018				
ENG M. Hart	7/9/2018	SCALE NONE	SIZE A	DRAWING NO. 060310	REV A
MFG					
QA					
CUST					
REVISED		DO NOT SCALE DRAWING			SHEET 2 OF 2