

WHITE AND BLACK CHIPS WITHOUT METALLIZATION

TOP VIEW

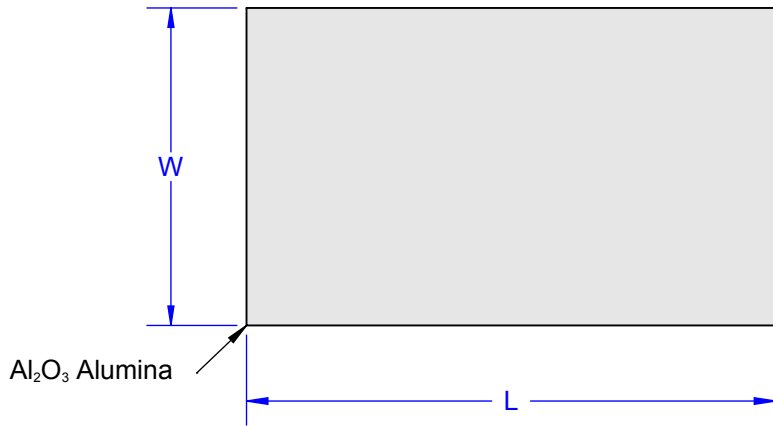

SIDE VIEW

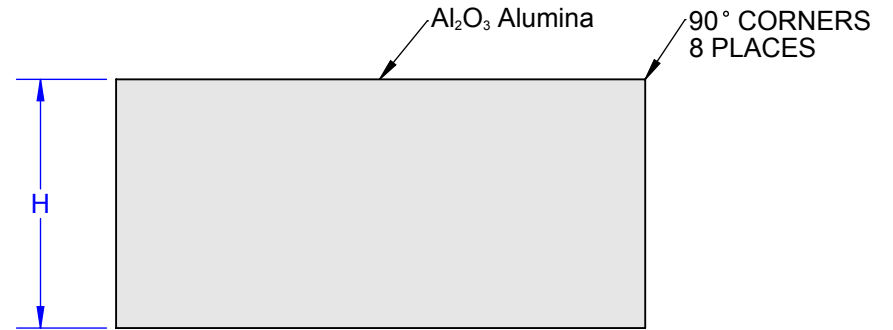

NOTES:

1. DIMENSION IN mm EXCEPT AS NOTED.
2. METALLIZATION: NONE.
3. Pb-FREE AND HALOGEN FREE.
4. COLORS: WHITE and BLACK.

PART NUMBER TABLE

SIZE CODE	COLOR	PART SERIES	SIZE (MM)				TOLERANCE	OUTLINE DRAWING
			L LENGTH	W WIDTH	H HEIGHT			
0805	WHITE	SCC0805E7A-WHITE	2.0	1.2	0.94	±0.076	080510	
0805	BLACK	SCC0805E7A-BLACK	2.0	1.2	0.94	±0.076	080511	

MODELS

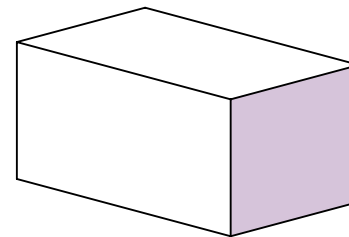

WHITE

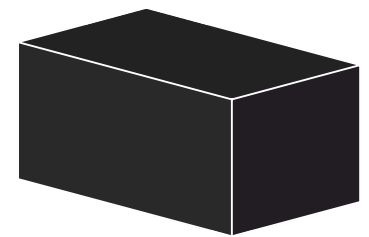

BLACK

APPROVALS	DATE	TopLine®			
DRAWN T.Au	08/12/14				
ENG M. Hart	08/12/14	TITLE SCC0805 UNTERMINATED CHIPS			
MFG		SCALE	SIZE	DRAWING NO.	REV
QA		35:1	A	080510	A
CUST		DO NOT SCALE DRAWING			SHEET 1 OF 2
REVISED					

W8P4 CARRIER TAPE DIMENSION

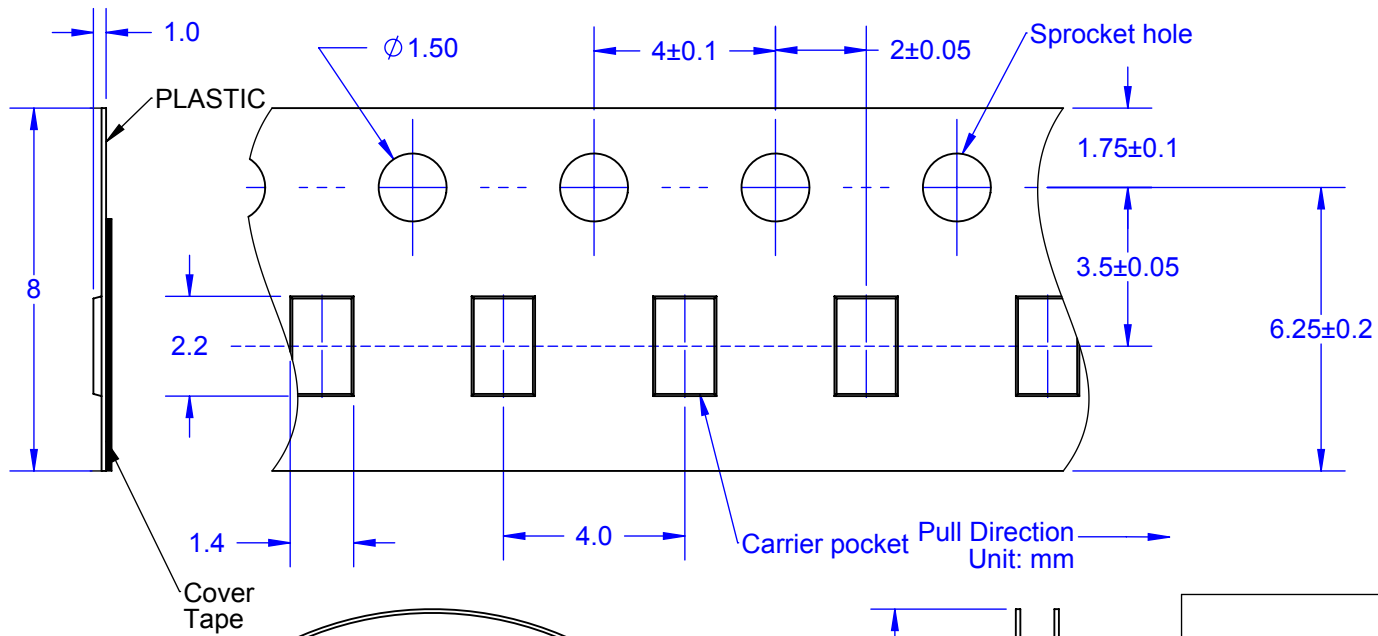

PART NUMBER SYSTEM

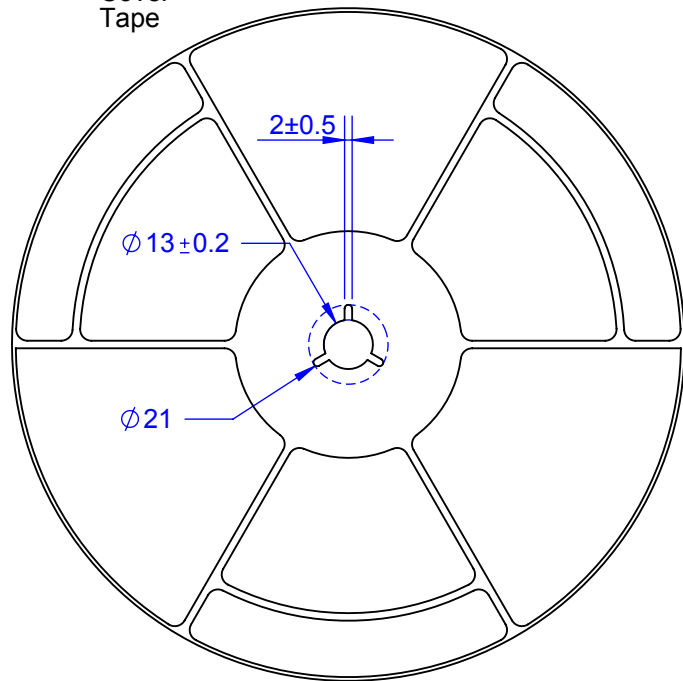
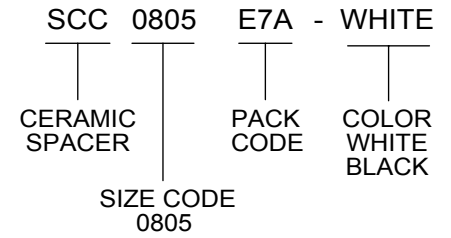

REEL DIMENSIONS

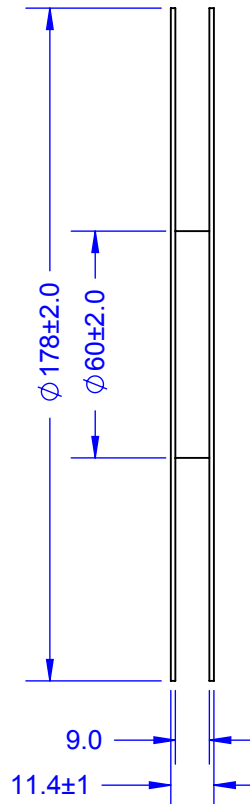

PACK CODE			
CODE	QTY	PACKAGE	TAPE
*E7A	4,000	REEL	PLASTIC
*E4A	1,000	REEL	PLASTIC

APPROVALS	DATE				
DRAWN T. Au	08/12/14				
ENG M. Hart	08/12/14	SCALE		SIZE	DRAWING NO.
MFG		NONE		A	080510
QA					REV
CUST					A
REVISED		DO NOT SCALE DRAWING			SHEET 2 OF 2