

TOP VIEW

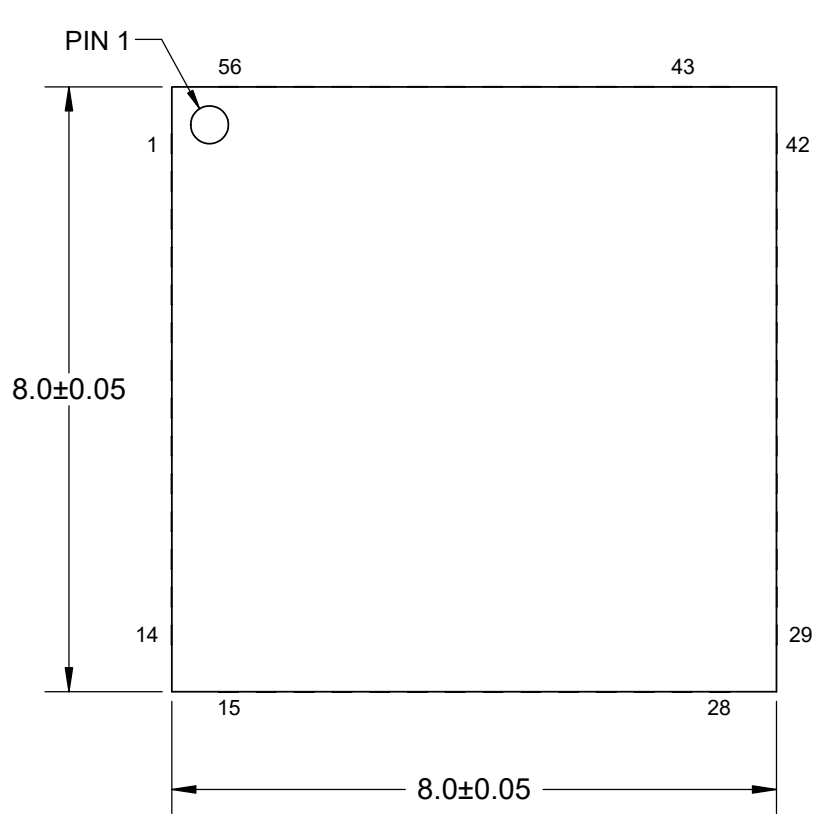

SIDE VIEW

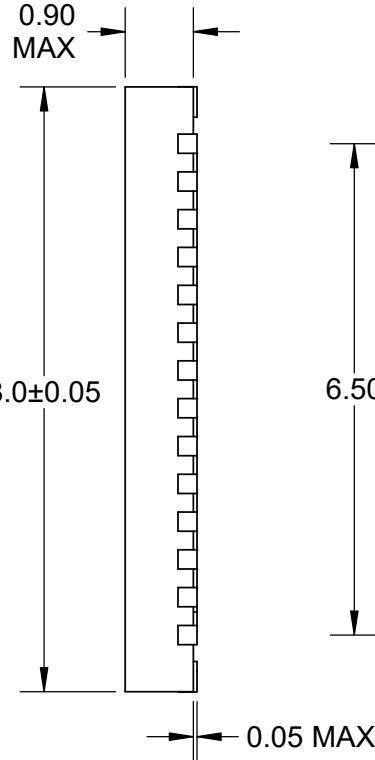

BOTTOM VIEW

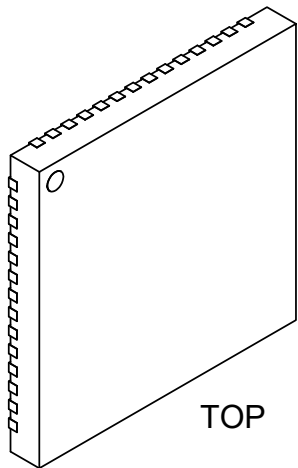
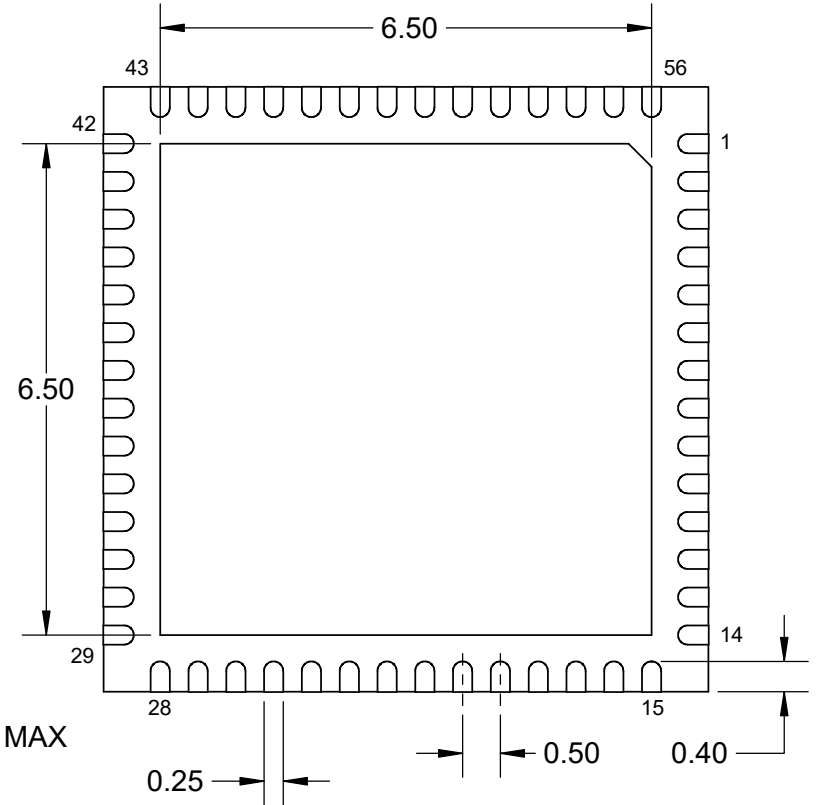

TOP

MODEL

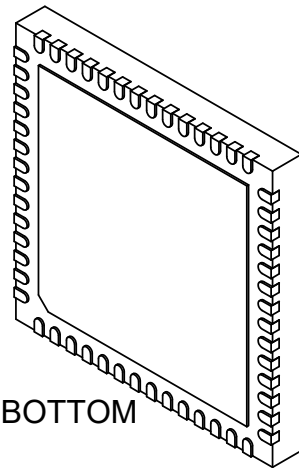

BOTTOM

Notes: (Unless Otherwise Specified).

- 1) BODY: PLASTIC, SEMICONDUCTOR GRADE.
- 2) LEAD FRAME: COPPER, C-194 F/H.
- 3) LEAD FRAME PLATING: Ni Pd Au.
- 4) FRAME THICKNESS: 0.203mm.
- 5) DIE PAD: 6.5 x 6.5mm EXPOSED BOTTOM.
- 6) JEDEC OUTLINE: MO-220.
- 7) DIMENSIONS IN mm.

APPROVALS	DATE	TopLine®			
DRAWN T. Au	6/3/2018				
ENG M. Hart	6/3/2018	TITLE 56-LEAD 8mm P0.5mm QFN DAISY CHAIN			
MFG		SCALE	SIZE	DRAWING NO.	REV
QA		6:1	A	455640	A
CUST		DO NOT SCALE DRAWING			SHEET 1 OF 5
REVISED					

DAISY CHAIN PATTERN

TOP VIEW

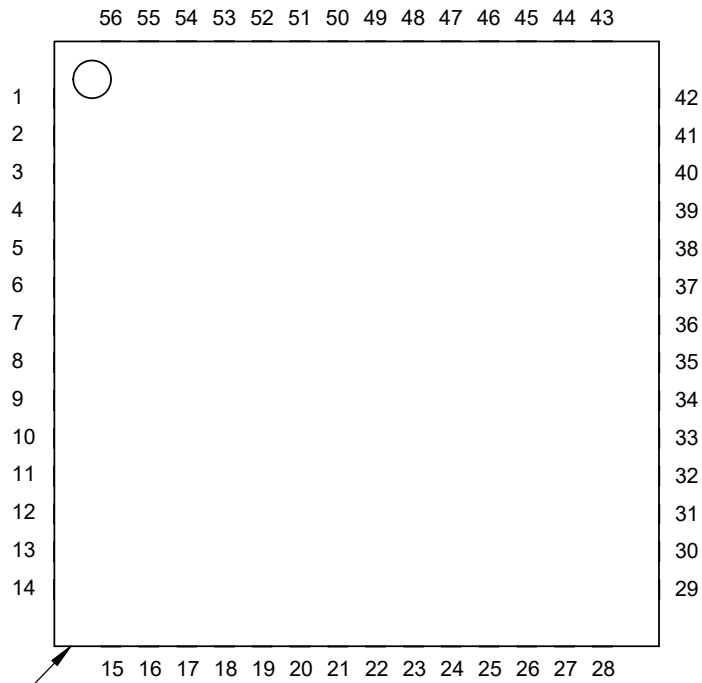

TOP SIDE ENCAPSULATION

SIDE VIEW

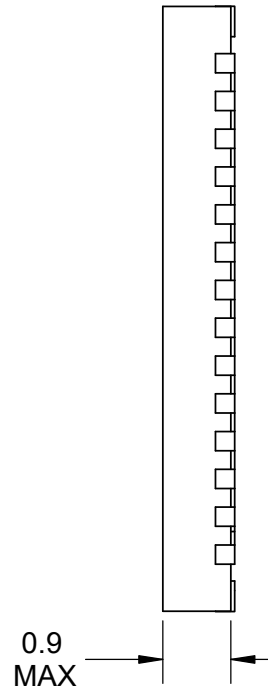

BOTTOM VIEW

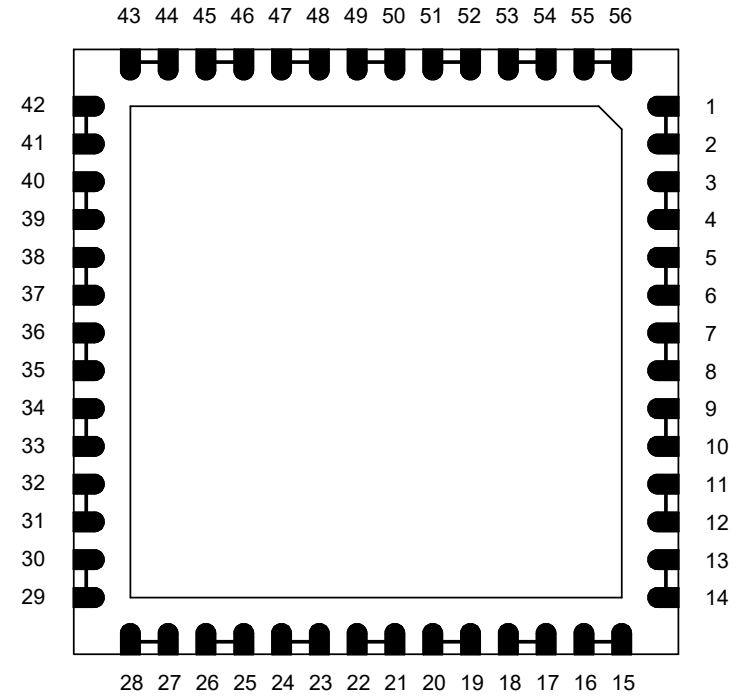

NOTE:
1. PACKAGE DAISY CHAIN BY WIRE BONDING TO INTERNAL BOND PADS.

TopLine[®]

TITLE 56-LEAD 8mm P0.5mm
QFN DAISY CHAIN

SCALE 10:1	SIZE A	DRAWING NO. 455640	REV A
---------------	-----------	-----------------------	----------

DO NOT SCALE DRAWING

SHEET 2 OF 5

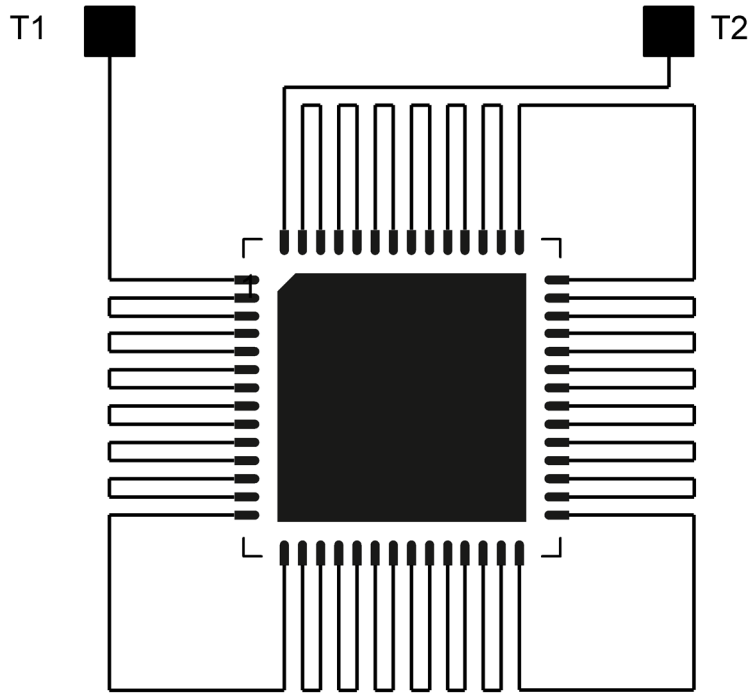

RECOMMENDED
PCB PADS

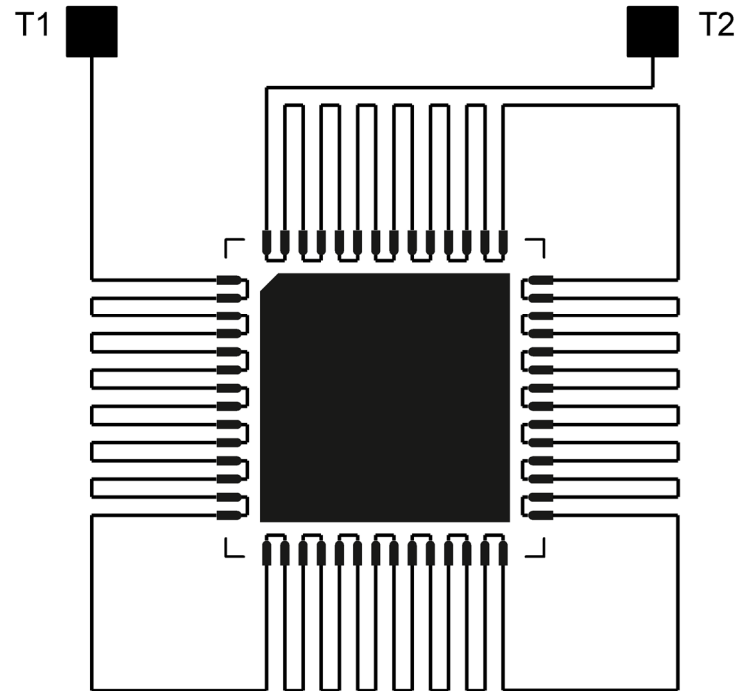

AFTER MOUNTING
ON PCB

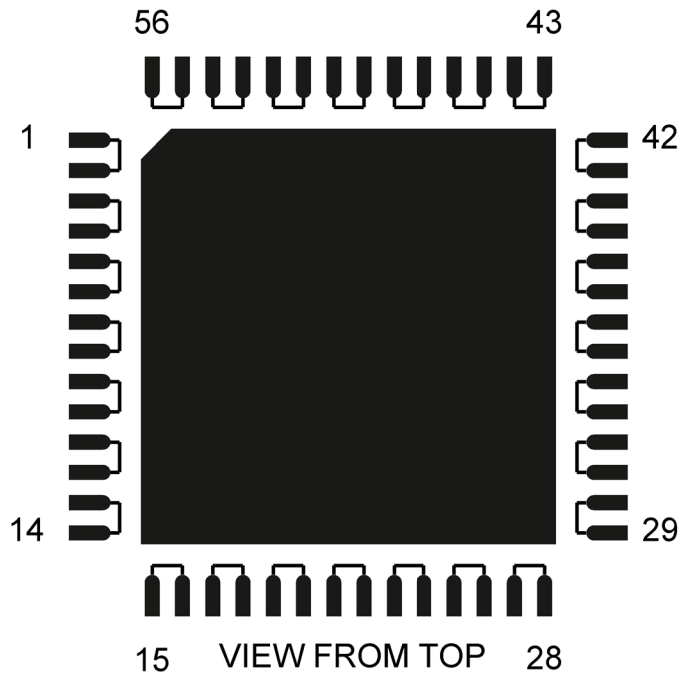

VIEW FROM TOP

DAISY CHAIN NET LIST		
PINS	PINS	PINS
1 ~ 2	3 ~ 4	5 ~ 6
7 ~ 8	9 ~ 10	11 ~ 12
13 ~ 14	15 ~ 16	17 ~ 18
19 ~ 20	21 ~ 22	23 ~ 24
25 ~ 26	27 ~ 28	29 ~ 30
31 ~ 32	33 ~ 34	35 ~ 36
37 ~ 38	39 ~ 40	41 ~ 42
43 ~ 44	45 ~ 46	47 ~ 48
49 ~ 50	51 ~ 52	53 ~ 54
55 ~ 56		

			
TITLE 56-LEAD 8mm P0.5mm QFN DAISY CHAIN			
SCALE 6:1	SIZE A	DRAWING NO. 455640	REV A
DO NOT SCALE DRAWING			SHEET 3 OF 5

**PC BOARD LAYOUT
DIMENSIONS IN MM
VIEW FROM TOP**

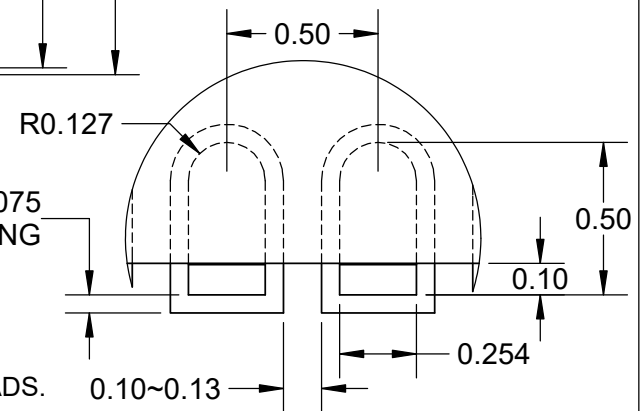
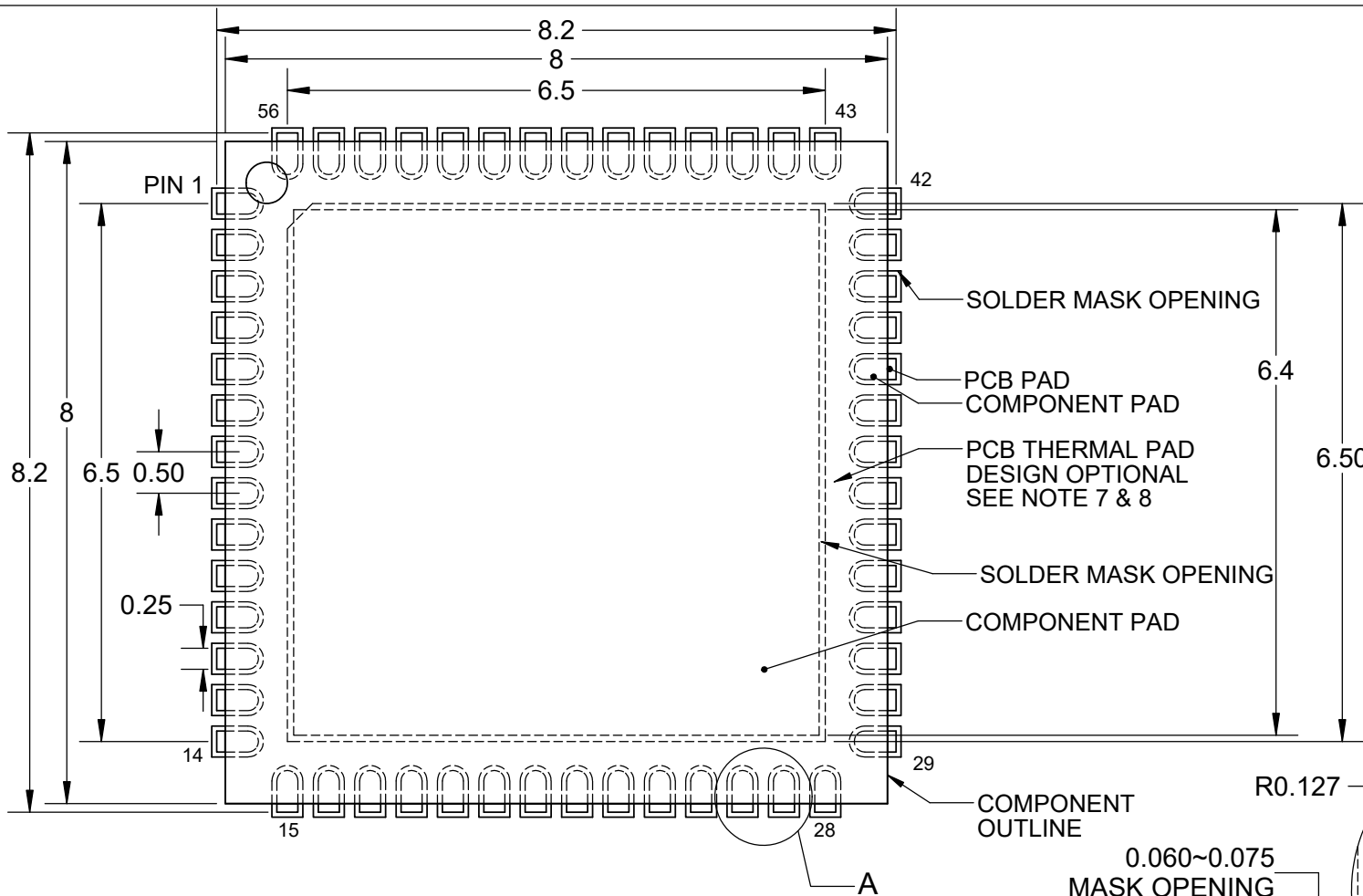

**DETAIL A
SCALE 40 : 1**

Notes: (Unless Otherwise Specified).

- 1) DIMENSIONS ARE PRESENTED ONLY AS A GUIDELINE.
DESIGNERS SHOULD USE THEIR OWN KNOWLEDGE BASE WHEN DESIGNING THE PCB.
- 2) SURROUND EACH SIDE OF I/O PERIMETER PADS WITH 0.060~0.075 mm (NSMD) SOLDER MASK OPENING (2.4~3.0mils) OPTIONALLY OK TO USE RECTANGLE (NSMD) MASK OPENING AROUND I/O PADS.
- 3) ROUNDED PCB LAND PADS REDUCE SOLDER BRIDGING. PAD CHAMFER ANGLE MAY VARY.
- 4) PCB LANDS SHOULD BE 0.2mm LONGER THAN THE PACKAGE I/O PADS.
- 5) THE WIDTH OF PERIMETER PCB PADS SHOULD MATCH (1:1) THE WIDTH OF THE PACKAGE PADS.
- 6) REFER TO INDUSTRY REFERENCES SUCH AS IPC-SM-782 FOR PCB LAND PATTERN DESIGN.
- 7) THERMAL GROUND PADS MAY BE CHANGED TO SUITE REQUIREMENTS OF THE DESIGNER.
 - A) MAKE COPPER THERMAL PAD AS LARGE AS POSSIBLE.
 - B) DRILL MULTIPLE THERMAL VIAS 0.25~0.33mm DIAMETER USING 0.8~1.2mm PITCH GRID.
 - C) PLATE THERMAL VIA BARRELS WITH 1-OUNCE COPPER (18µm).
 - D) TENT (COVER) THERMAL VIAS WITH SOLDER MASK 0.1mm LARGER THAN THE VIA DIAMETER.
- 8) STENCIL DESIGN MAY BE CHANGED TO SUIT REQUIREMENTS OF THE DESIGNER.
 - A) LASER CUT STENCIL 0.125mm (5mil) THICK. APERTURE SIZE-TO-LAND RATIO OF 1:1.
 - B) THE SOLDER PASTE OPENING IN THE THERMAL PAD AREA SHOULD BE A MATRIX ARRAY OF SMALLER APERTURES INSTEAD OF ONE LARGE APERTURE TO CONTROL PASTE AMOUNTS.
 - C) APPLY 50% TO 80% SOLDER PASTE COVERAGE IN THE PAD AREA.

TopLine®			
TITLE 56-LEAD 8mm P0.5mm QFN DAISY CHAIN			
SCALE 8:1	SIZE A	DRAWING NO. 455640	REV A
DO NOT SCALE DRAWING			SHEET 4 OF 5

PART NUMBERING SYSTEM

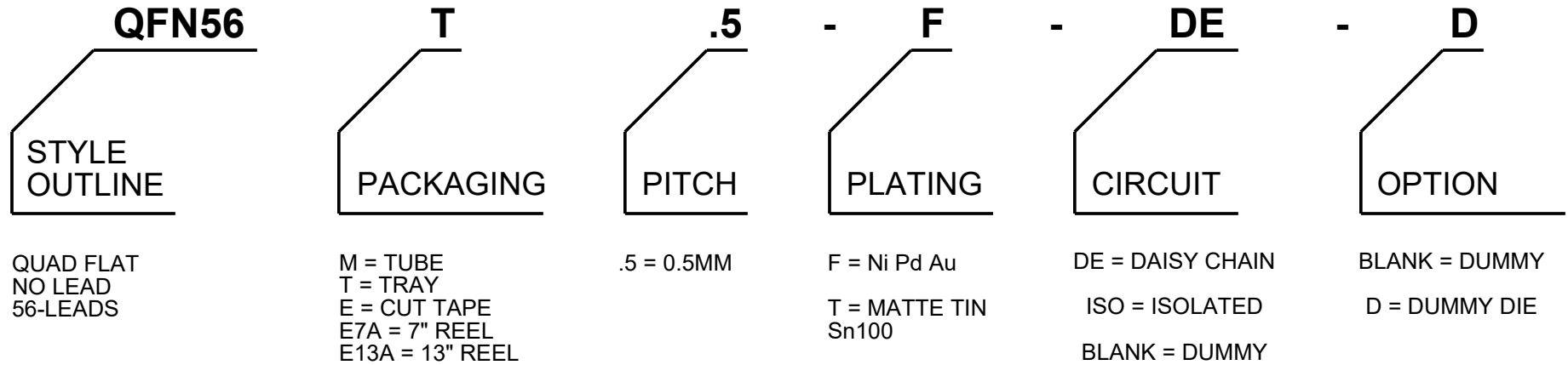

PART NUMBER	DAISY CHAIN	PACKAGING	RoHS Pb-FREE	MSL LEVEL	DUMMY DIE
QFN56T.5-F-DE-D	YES	JEDEC TRAY	YES	1	YES
QFN56M.5-F-DE-D	YES	TUBE	YES	1	YES
QFN56E7A.5-F-DE-D	YES	REEL	YES	1	YES
QFN56T.5-F	NO	JEDEC TRAY	YES	1	NO
QFN56M.5-F	NO	TUBE	YES	1	NO

OTHER PART NUMBER COMBINATIONS AVAILABLE. CONTACT TOPLINE.

TopLine®			
TITLE		56-LEAD 8mm P0.5mm QFN DAISY CHAIN	
SCALE	SIZE	DRAWING NO.	REV
NONE	A	455640	A
DO NOT SCALE DRAWING			SHEET 5 OF 5