

TOP VIEW

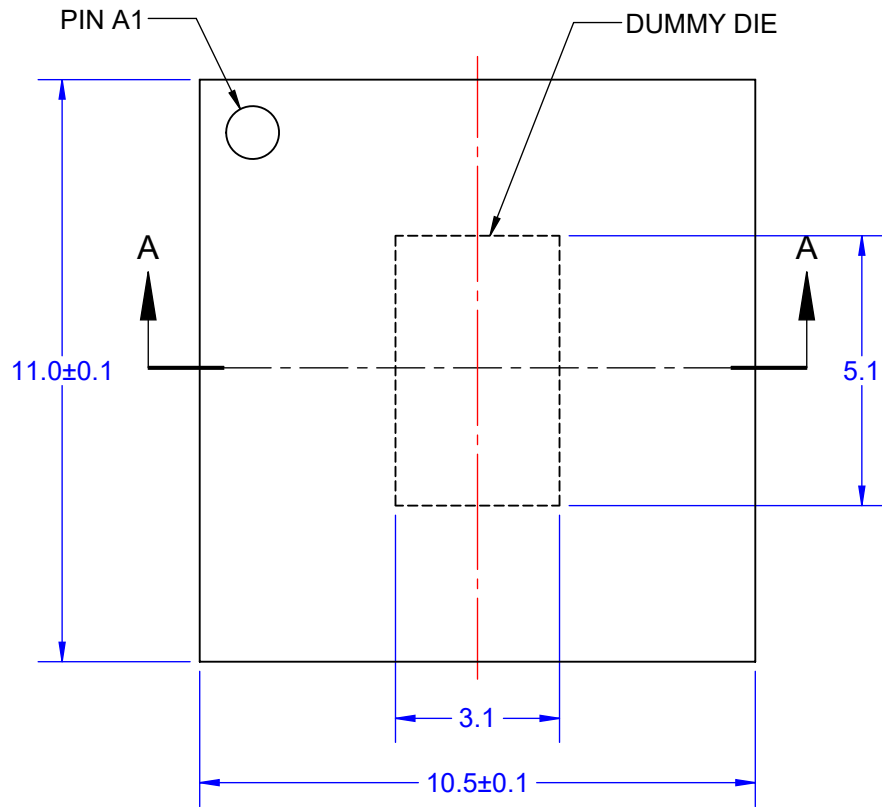

BALL VIEW

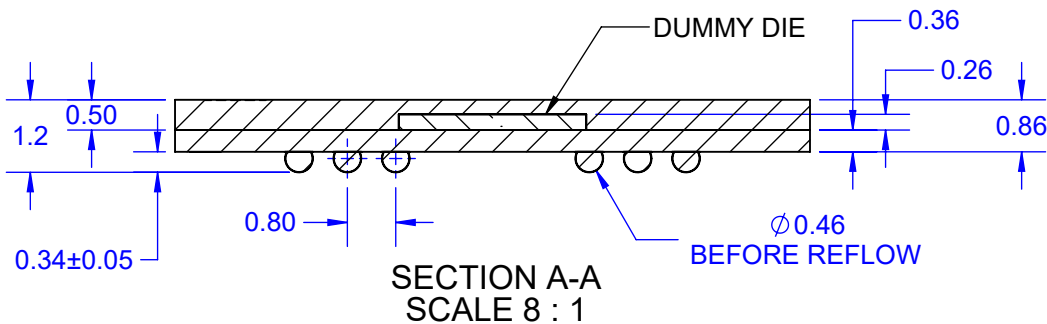
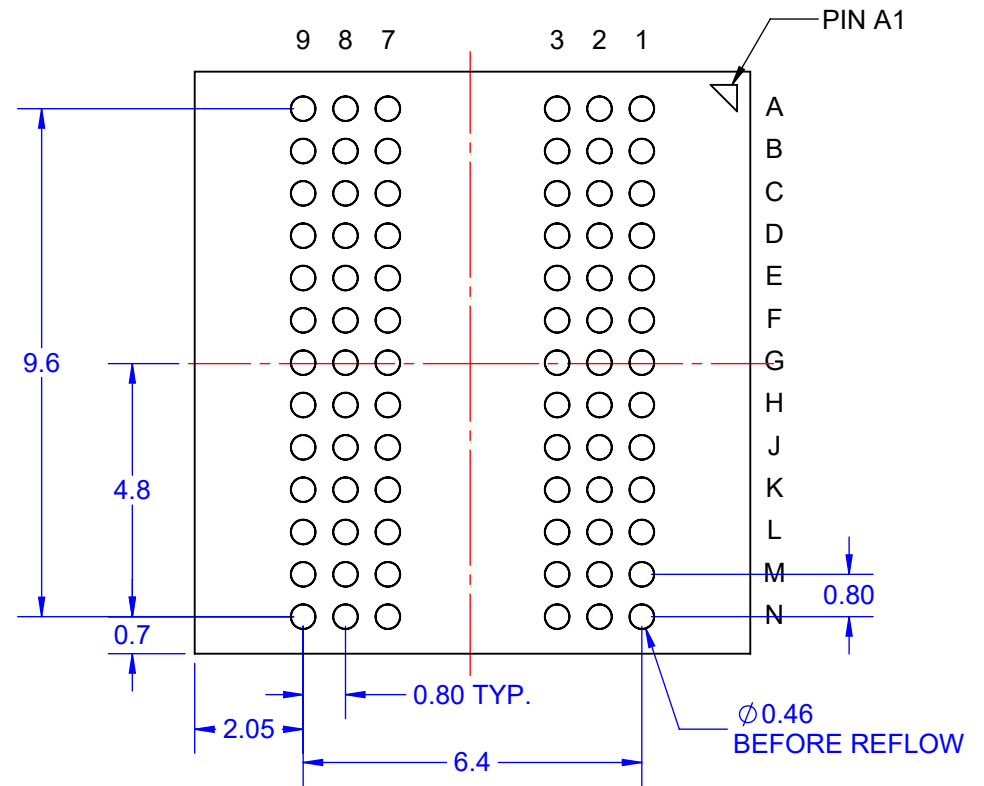

Notes: Unless Otherwise Specified).

- 1) ALL DIMENSIONS ARE IN MM.
- 2) SOLDER BALL ALLOY: SEE PART NUMBER TABLE.
- 3) BALL DIAMETER (BEFORE REFLOW): 0.46mm.
- 4) SOLDER MASK DEFINED PAD OPENING: 0.42mm (16.5 MIL).
- 5) PAD Cu DIAMETER: 0.61mm (24.0 MIL).
- 6) SUBSTRATE MATERIAL: BT.
- 7) DUMMY DIE SIZE: OPTIONAL.
- 8) DAISY CHAIN PATTERN (SEE PAGE 2).
- 9) MSL-3 RECOMMENDED BAKING 24 HOURS @ 125°C TO REMOVE MOISTURE PRIOR TO SOLDERING TO PC BOARD.

PART NUMBER TABLE				
PART NUMBER	BALL ALLOY	BALL CODE	RoHS	Si DIE
BGA78T.8C-DC636D	Sn96.8 Sn3.0 Cu0.2	SAC302	YES	YES
BGA78T.8-DC636D	Sn63/Pb37	Sn63	NO	YES

APPROVALS	DATE				
DRAWN T.Au	8/25/2023				
ENG M. Hart	8/25/2023	TITLE BGA78T.8C-DC636D DAISY CHAIN 11x10.5mm			
MFG		SCALE 7:1	SIZE A	DRAWING NO. 586361	REV A
CUST		DO NOT SCALE DRAWING			SHEET 1 OF 3
REVISED					

BALL VIEW

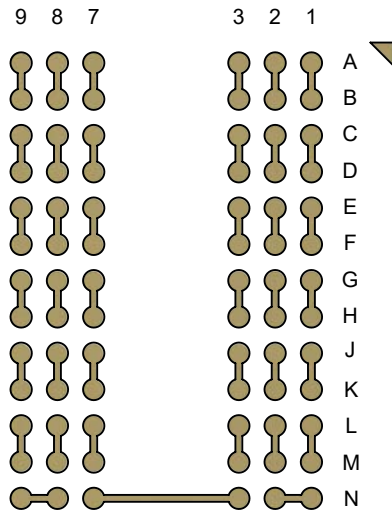

BOTTOM SIDE (TOP X-RAY VIEW)

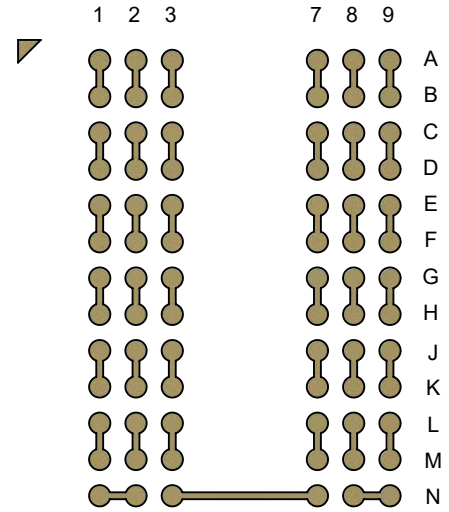

TEST VEHICLE BOARD

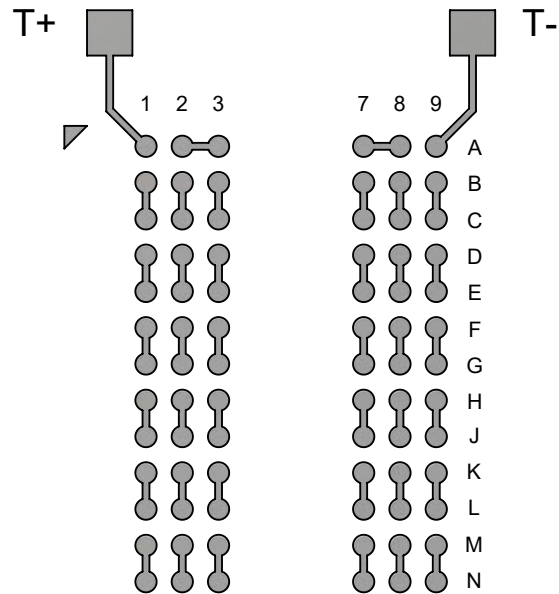

AFTER MOUNTING

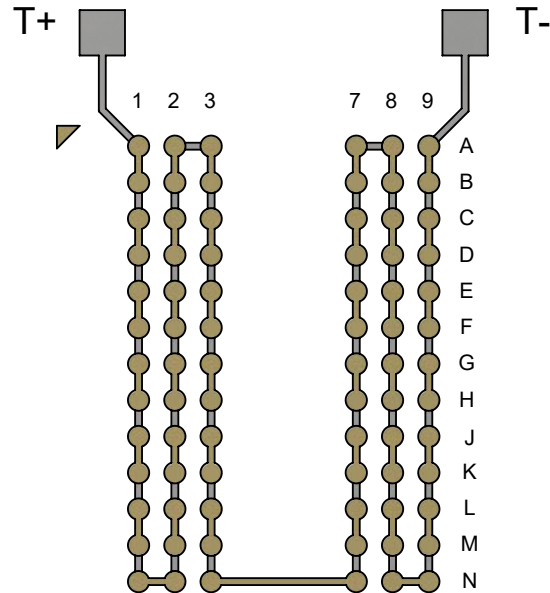

Notes:

- 1) PCB BOARD DIMENSIONS ARE PRESENTED ONLY AS A GUIDELINE. DESIGNERS SHOULD USE THEIR OWN EXPERIENCE WHEN DESIGNING PCB.
- 2) PCB Cu PAD 0.40mm (15.7 MIL) VIA IN PAD (VIPPO) OPTIONAL.
- 3) PCB DAISY CHAIN TRACING LINE WIDTH 0.152mm (6 MIL).
- 4) MASK OPENING 0.5mm (19.7 MIL) NSMD.

TopLine[®]

TITLE BGA78T.8C-DC636D
DAISY CHAIN 11x10.5mm

SCALE 6:1	SIZE A	DRAWING NO. 586361	REV A
--------------	-----------	-----------------------	----------

DO NOT SCALE DRAWING

SHEET 2 OF 3

MODEL

TOP

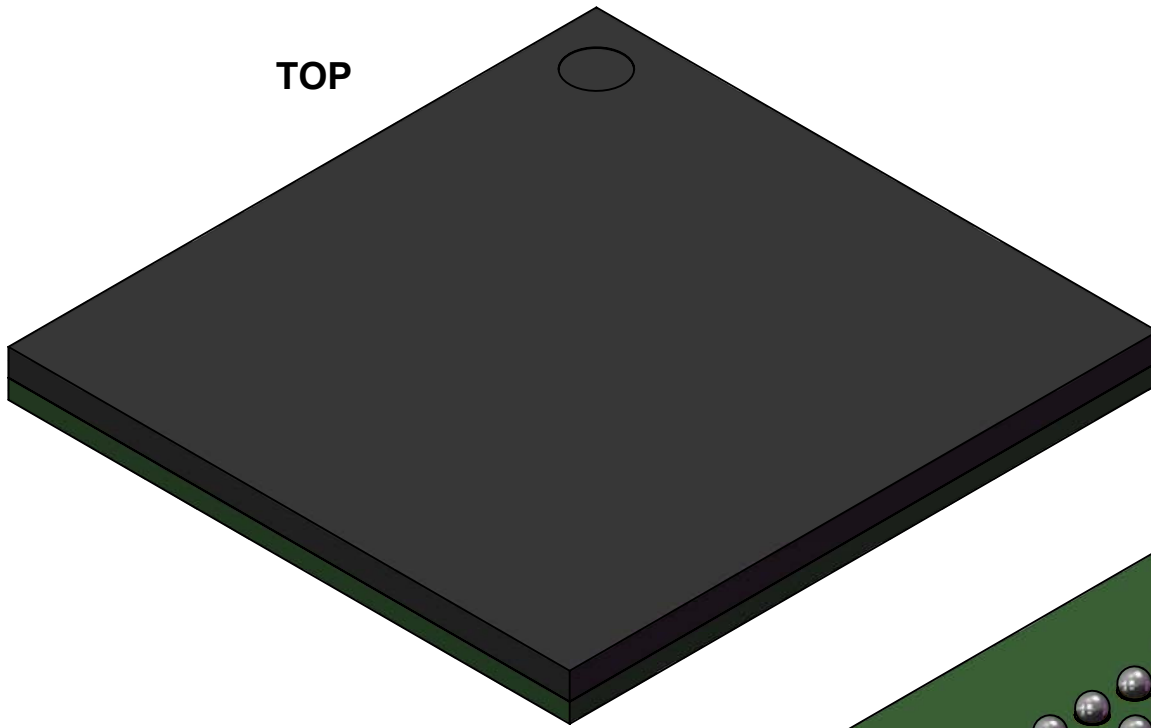

BOTTOM

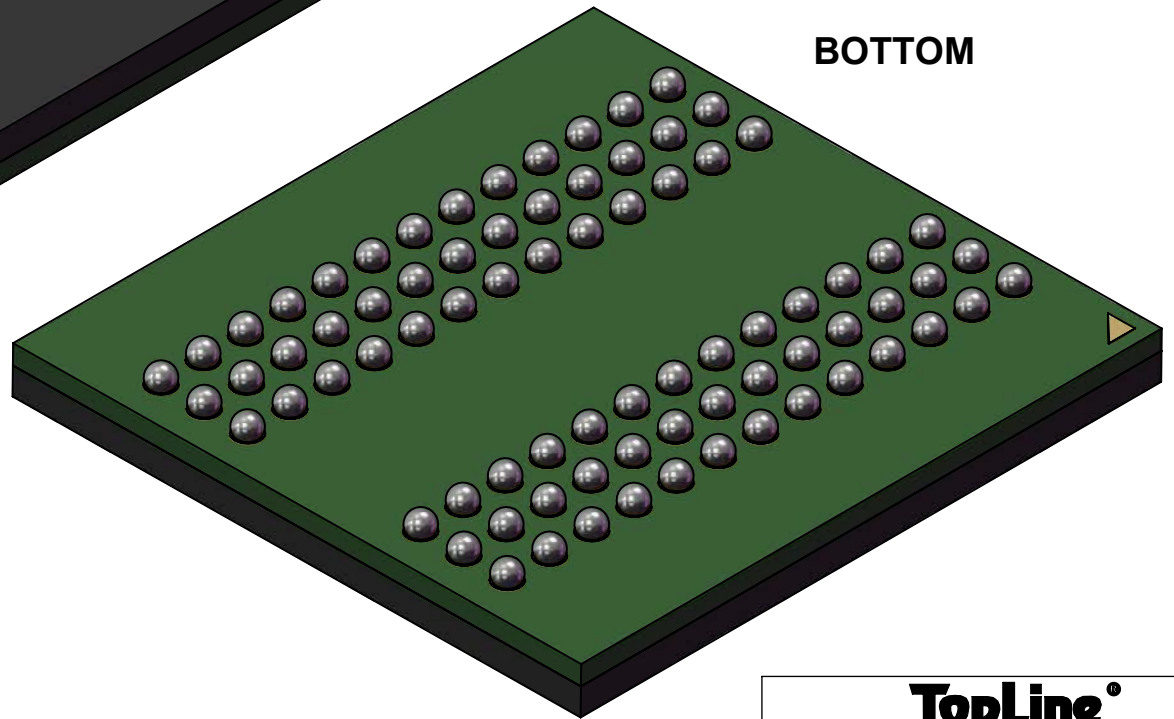

TopLine[®]

TITLE BGA78T.8C-DC636D
DAISY CHAIN 11x10.5mm

SCALE 8:1	SIZE A	DRAWING NO. 586361	REV A
--------------	-----------	-----------------------	----------

DO NOT SCALE DRAWING SHEET 3 OF 3