

**TOP**

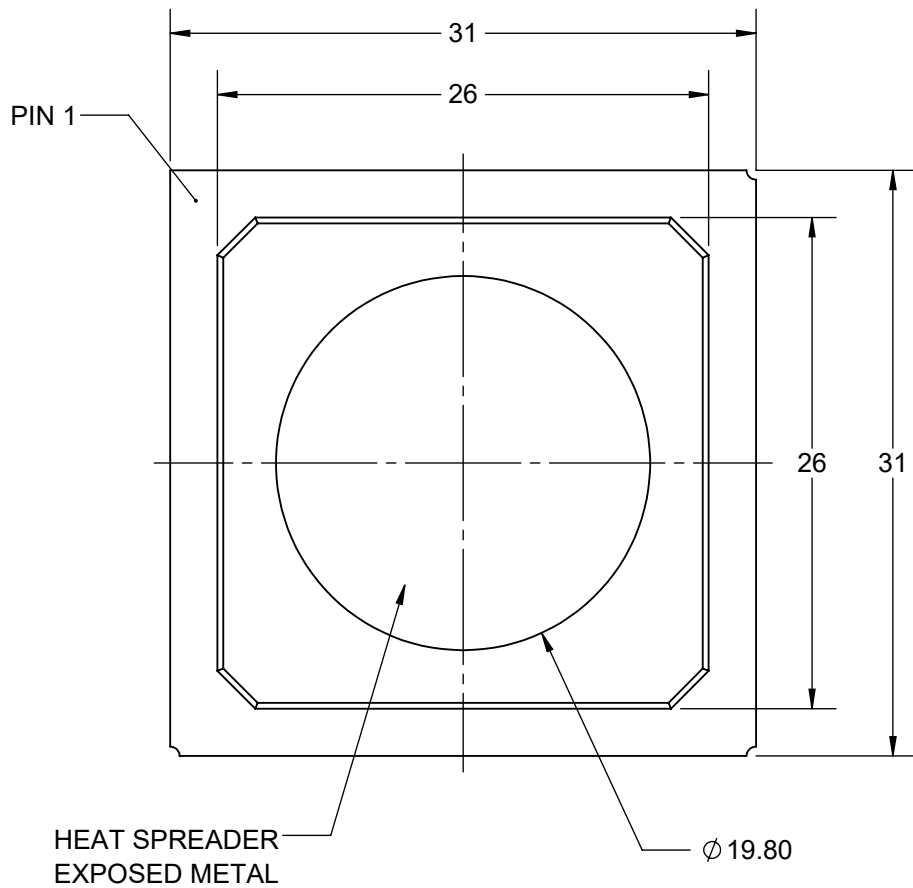

**SIDE**

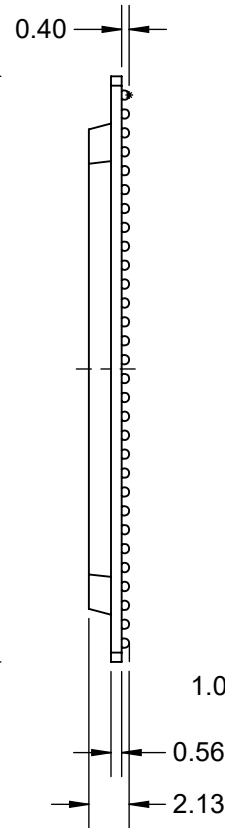

**BOTTOM**

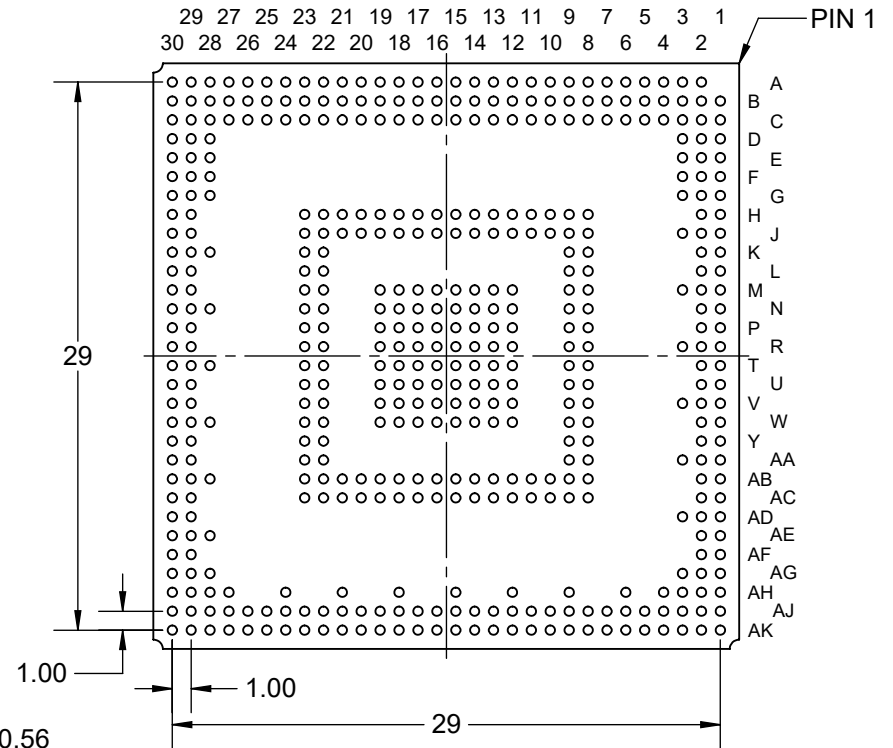

**NOTES:**

- 1) DIMENSIONS MM.
- 2) SOLDER MASK OPENING 0.38mm.
- 3) BALL DIAMETER 0.50mm (BEFORE REFLOW).

APPROVALS	DATE	<b>TopLine®</b>			
DRAWN T.Au	12/17/2019				
ENG M. Hart	12/17/2019	TITLE HSBGA458T1.0			
MFG		SCALE 2.5:1	SIZE A	DRAWING NO. 513002	REV A
QA					
CUST		DO NOT SCALE DRAWING			SHEET 1 OF 7
REVISED					

### SOLDER BALL

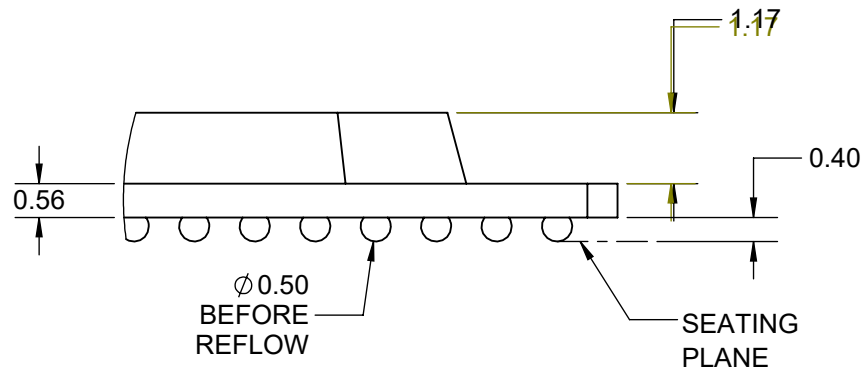

DETAIL A

### SOLDER COLUMN

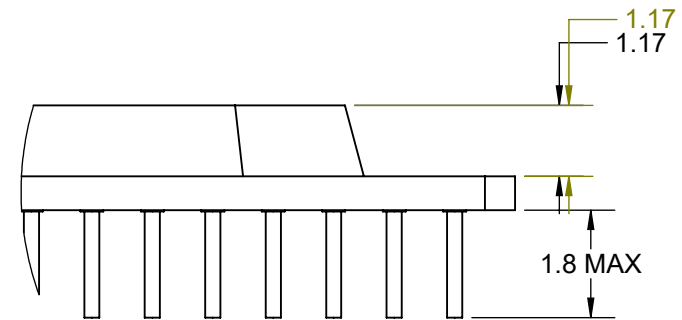

DETAIL B

### LGA LAND GRID ARRAY

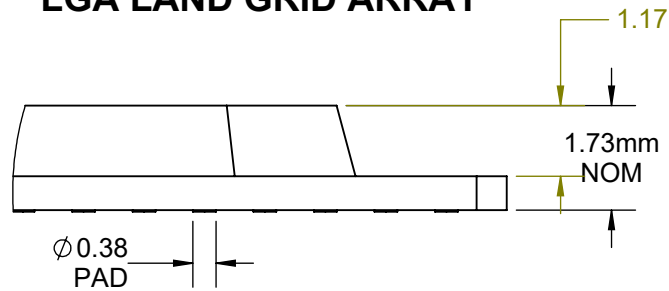

DETAIL C

### MICRO-COIL SPRING

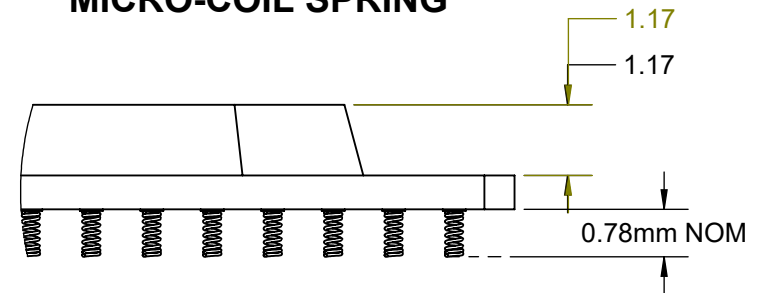

DETAIL D

**TopLine®**

TITLE HSBGA458T1.0

SCALE 8:1	SIZE A	DRAWING NO. 513002	REV A
--------------	-----------	-----------------------	----------

DO NOT SCALE DRAWING SHEET 2 OF 7

# BGA MODEL WITH SOLDER BALLS

TOP

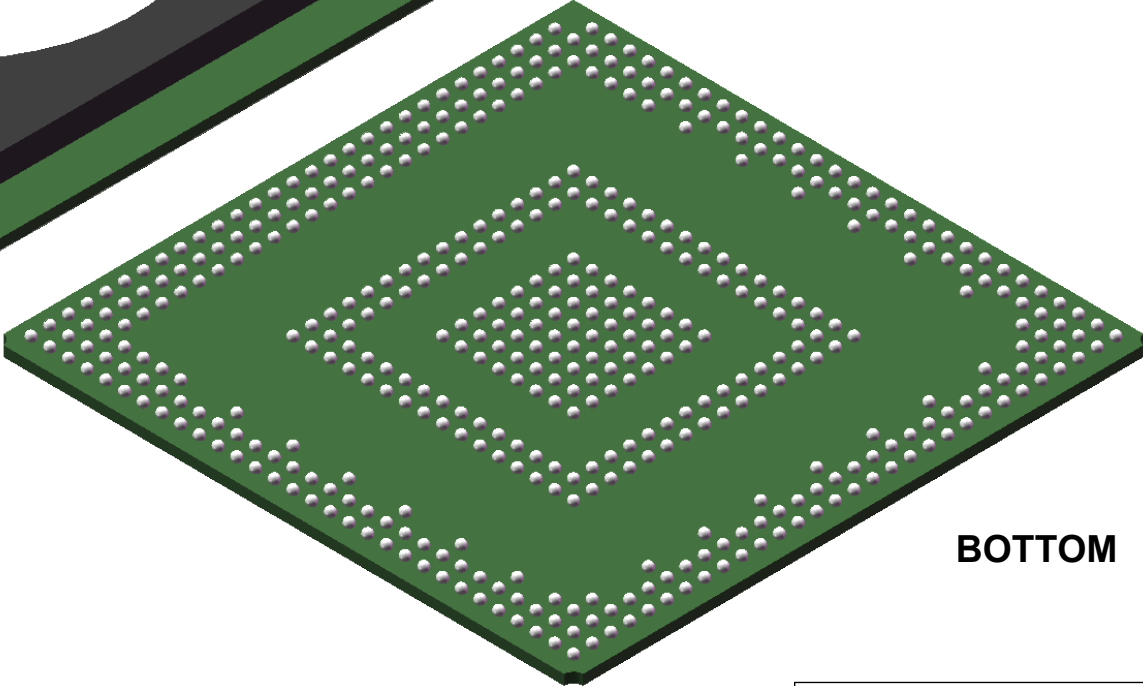
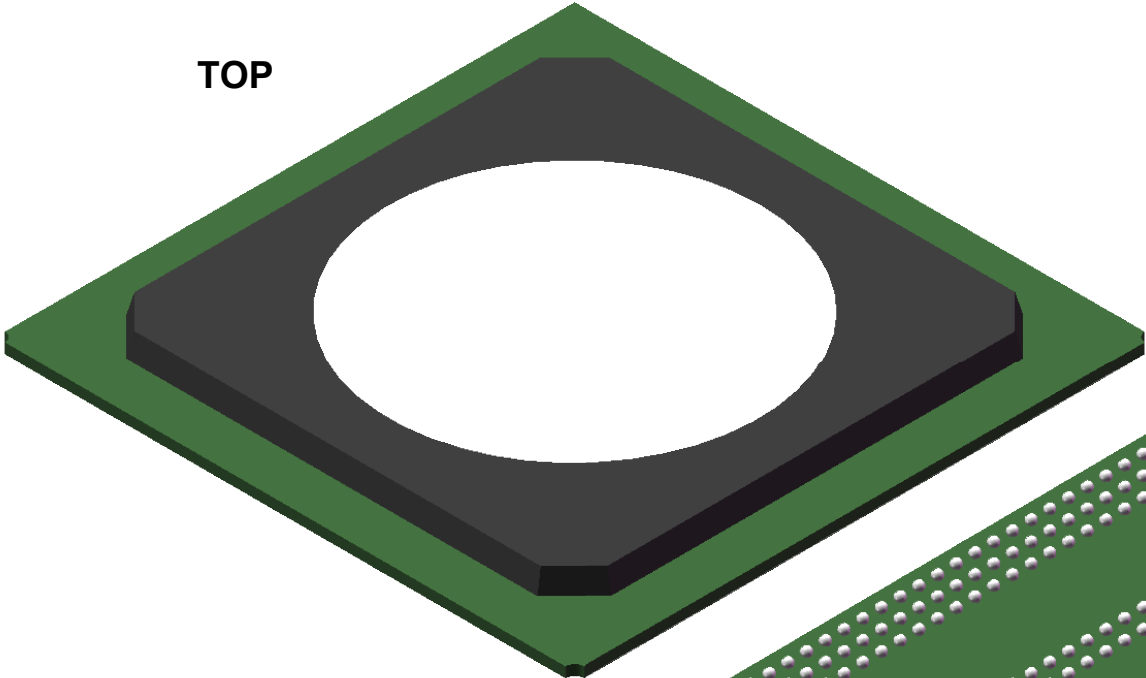

BOTTOM

<b>TopLine<sup>®</sup></b>			
TITLE		HSBGA458T1.0	
SCALE	SIZE	DRAWING NO.	REV
3.5:1	A	513002	A
DO NOT SCALE DRAWING			SHEET 3 OF 7

# LGA MODEL WITHOUT SOLDER BALLS

TOP

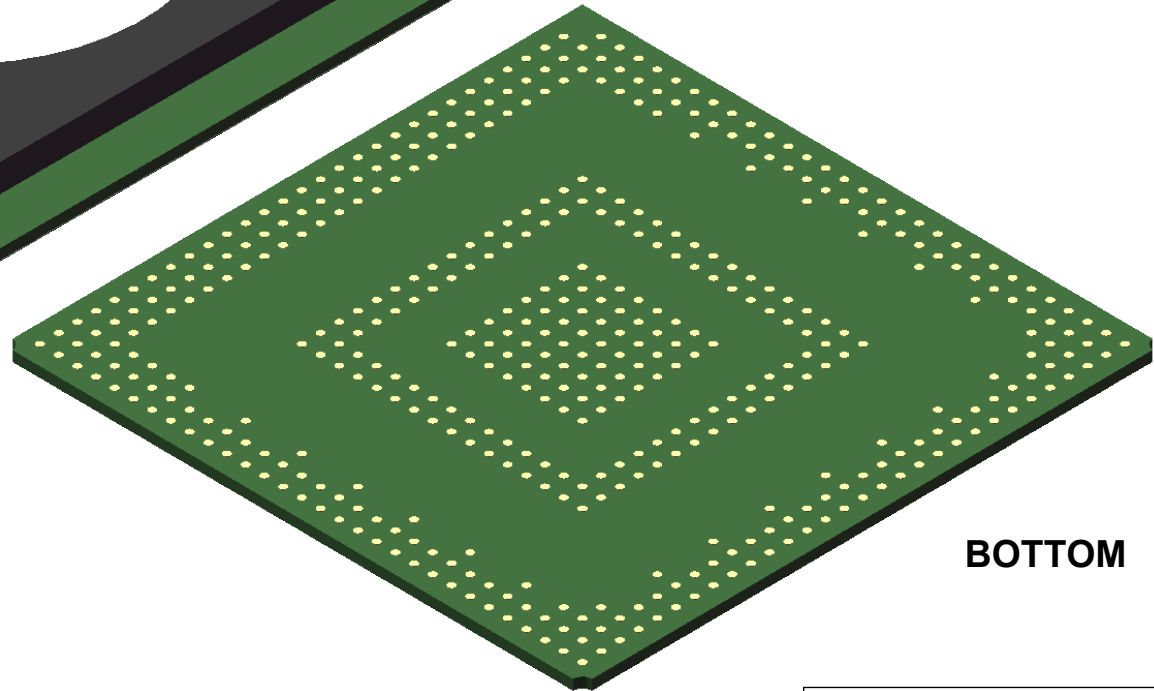
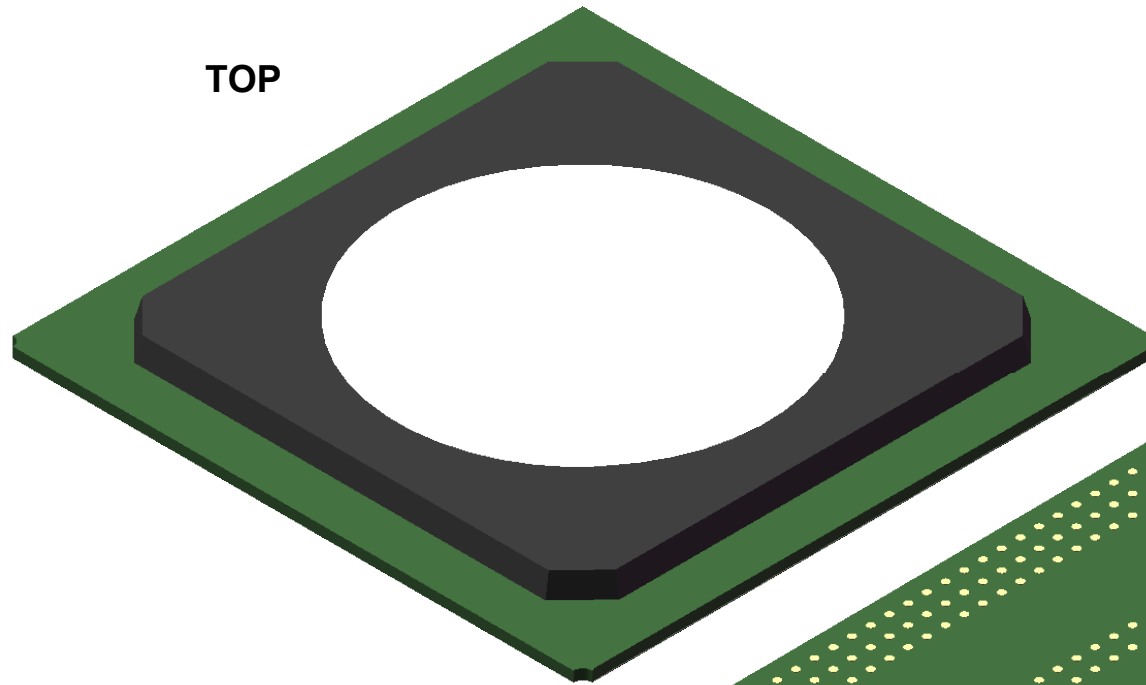

BOTTOM

**TopLine**<sup>®</sup>

TITLE			
HSBGA458T1.0			
SCALE	SIZE	DRAWING NO.	REV
3.5:1	A	513002	A
DO NOT SCALE DRAWING			SHEET 4 OF 7

# CGA MODEL WITH SOLDER COLUMNS

# DETAIL E SOLDER COLUMN OPTIONS

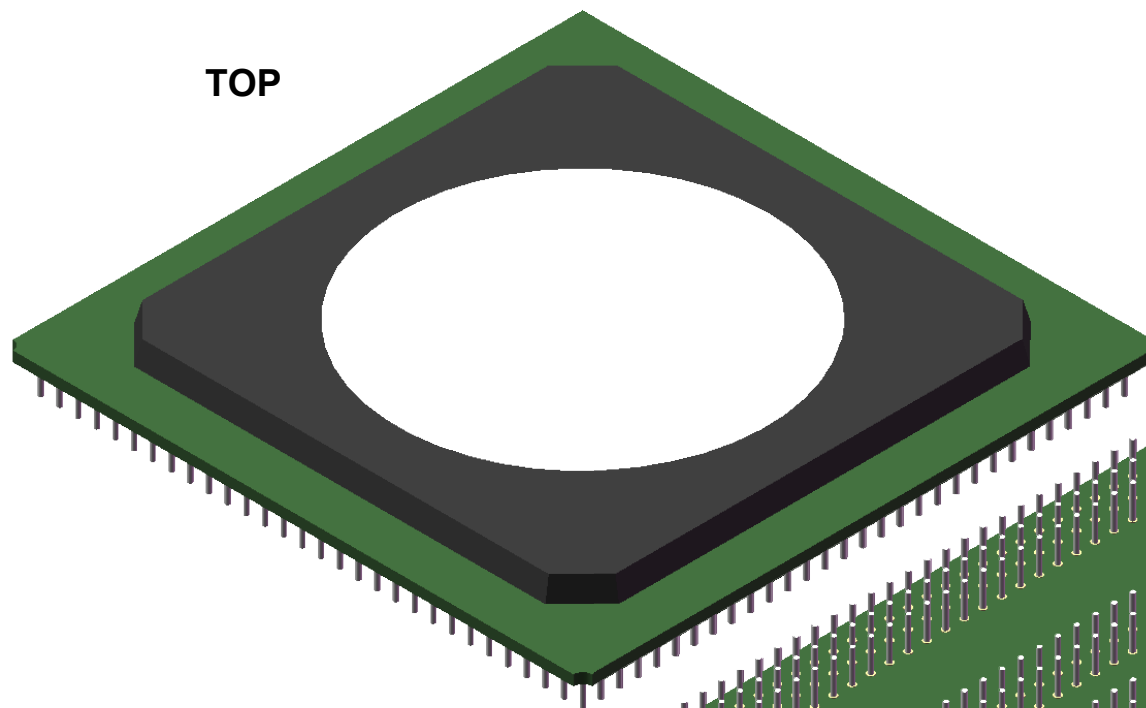

TOP

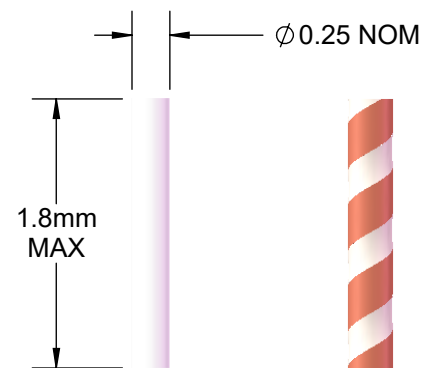

Pb90/Sn10

Pb80/Sn20  
COPPER  
RIBBON

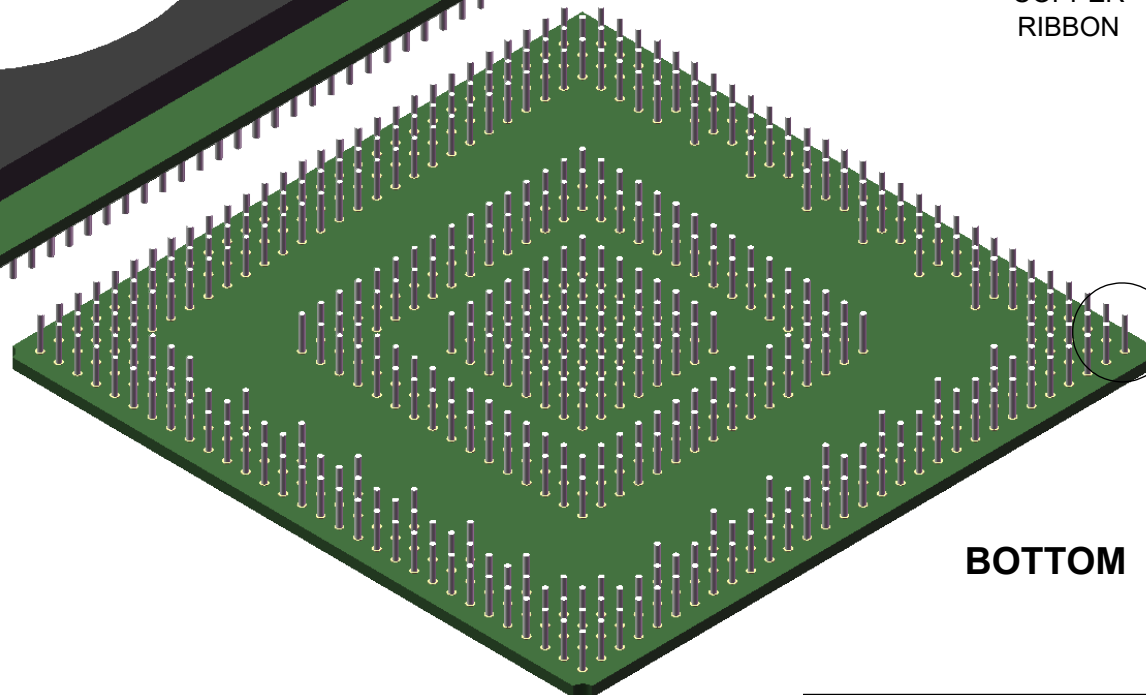

BOTTOM

**TopLine**<sup>®</sup>

TITLE HSBGA458T1.0

SCALE 3.5:1	SIZE A	DRAWING NO. 513002	REV A
----------------	-----------	-----------------------	----------

DO NOT SCALE DRAWING

SHEET 5 OF 7

**CGA MODEL  
WITH MICRO-COIL SPRING**

**DETAIL E  
PLATING OPTIONS**

TOP

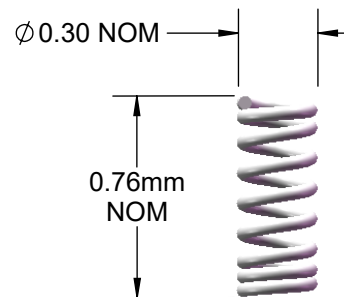
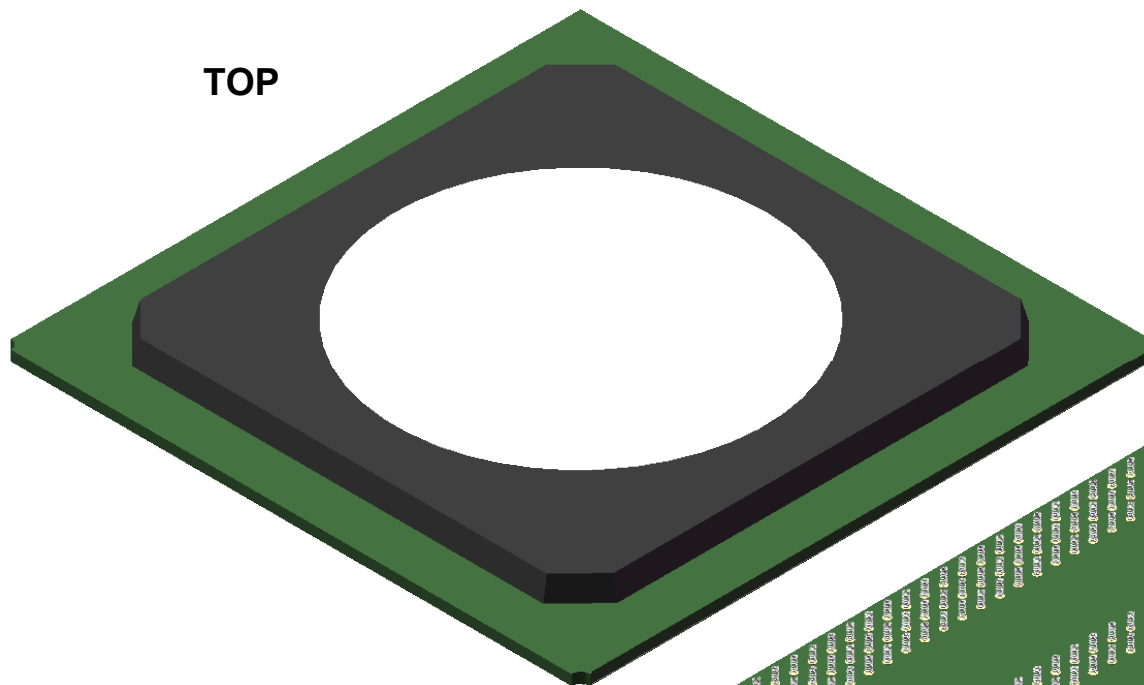

SnPb

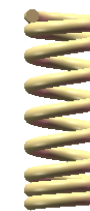

Ni-Au

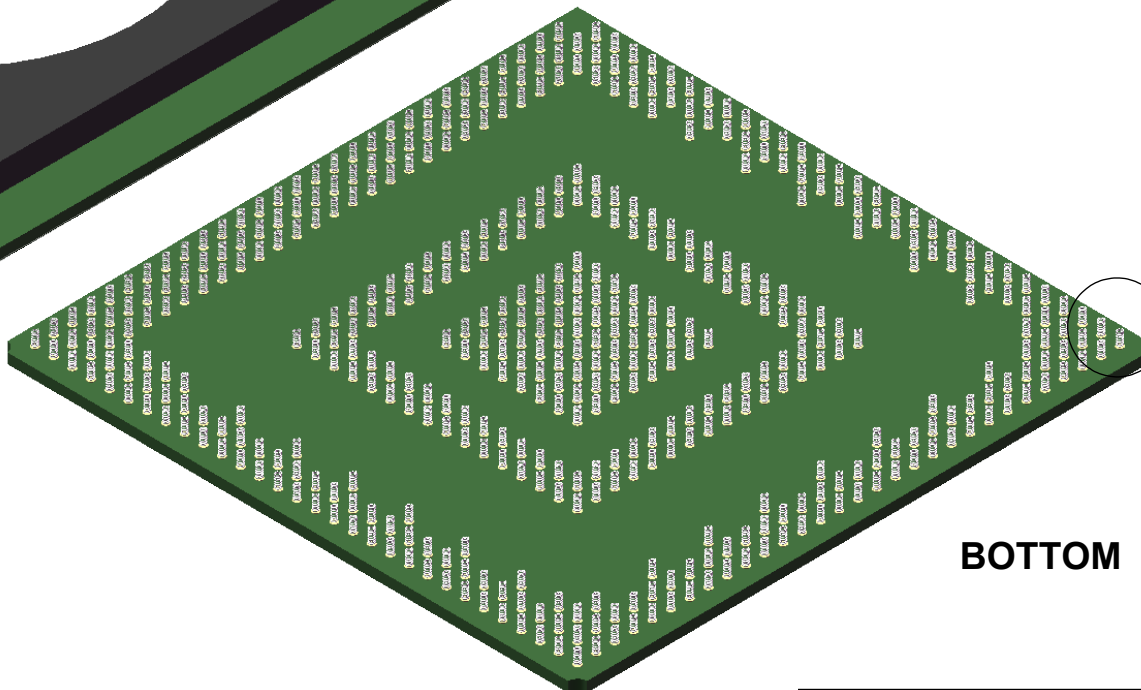

BOTTOM

<b>TopLine®</b>			
TITLE		HSBGA458T1.0	
SCALE	SIZE	DRAWING NO.	REV
3.5:1	A	513002	A
DO NOT SCALE DRAWING			SHEET 6 OF 7

# SOLDER MASK OPENING

30 29 28 27 26 25 24 23 22 21 20 19 18 17 16 15 14 13 12 11 10 9 8 7 6 5 4 3 2 1

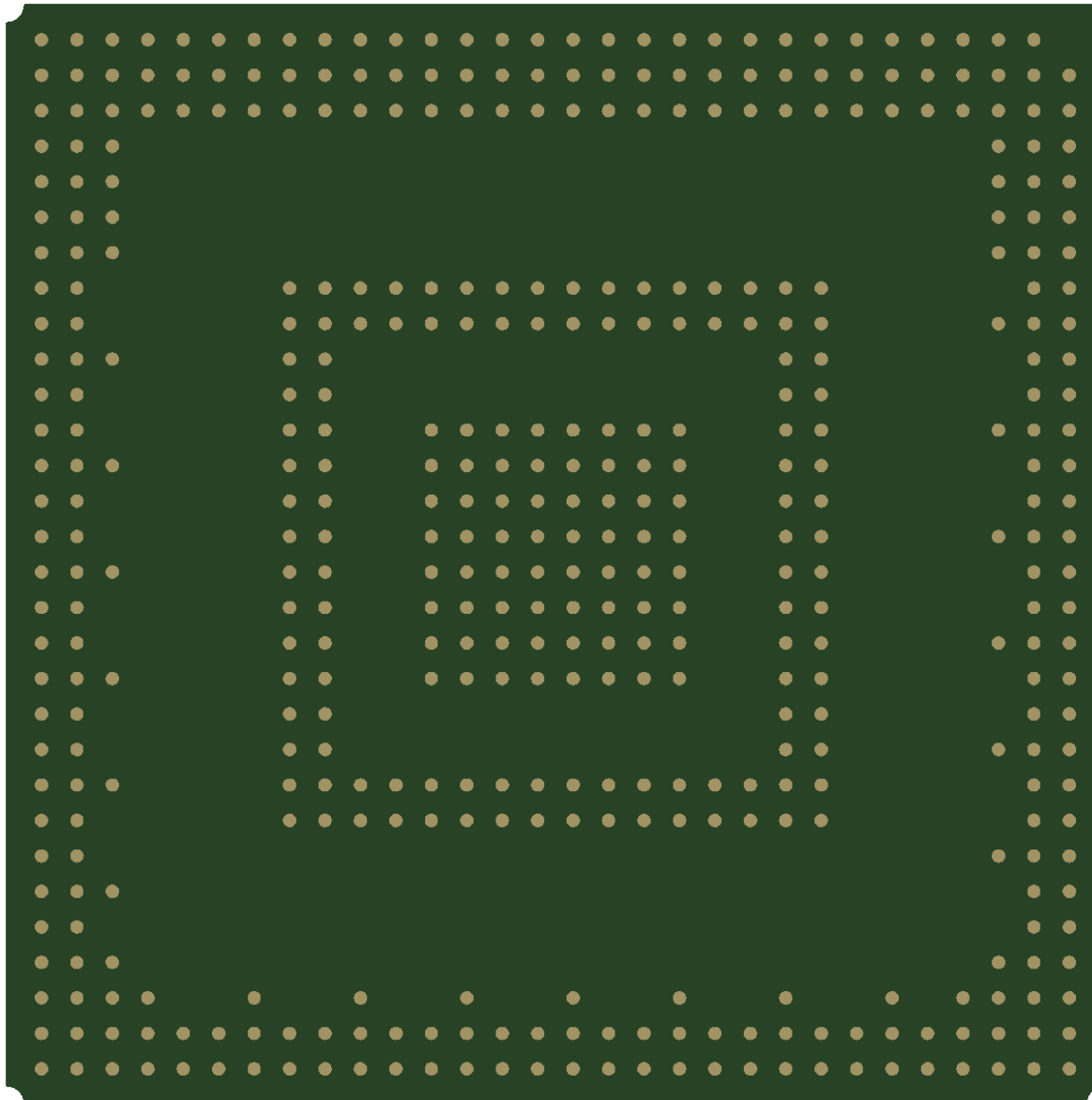

A  
B  
C  
D  
E  
F  
G  
H  
J  
K  
L  
M  
N  
P  
R  
T  
U  
V  
W  
Y  
AA  
AB  
AC  
AD  
AE  
AF  
AG  
AH  
AJ  
AK

<b>TopLine<sup>®</sup></b>			
TITLE		HSBGA458T1.0	
SCALE	SIZE	DRAWING NO.	REV
5:1	A	513002	A
DO NOT SCALE DRAWING			SHEET 7 OF 7