

BOTTOM VIEW

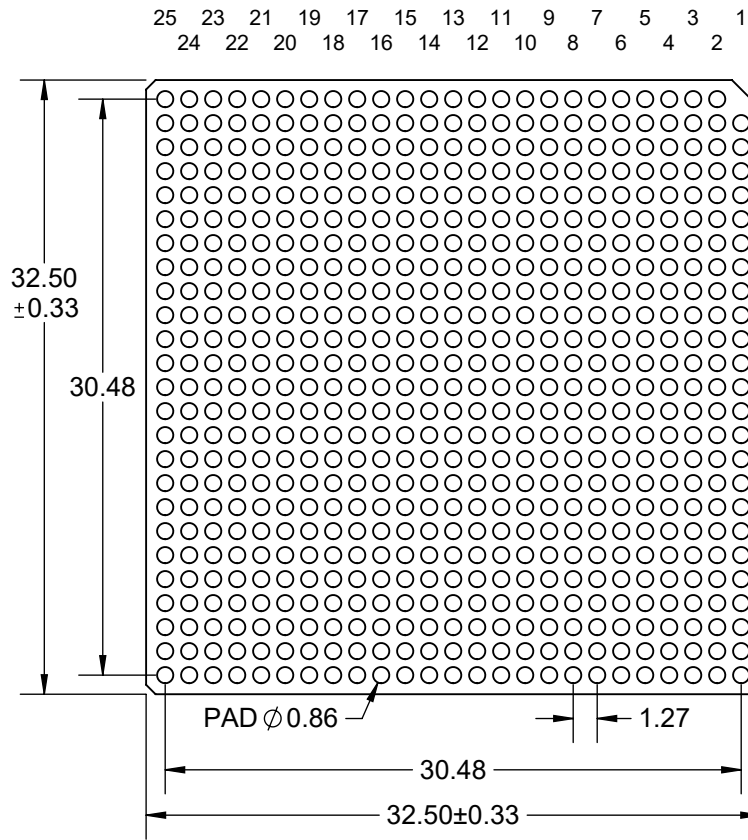

SIDE VIEW

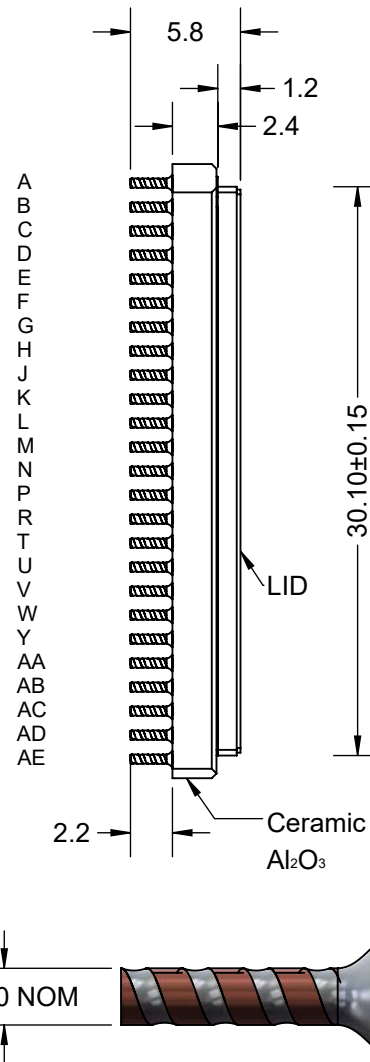

TOP VIEW

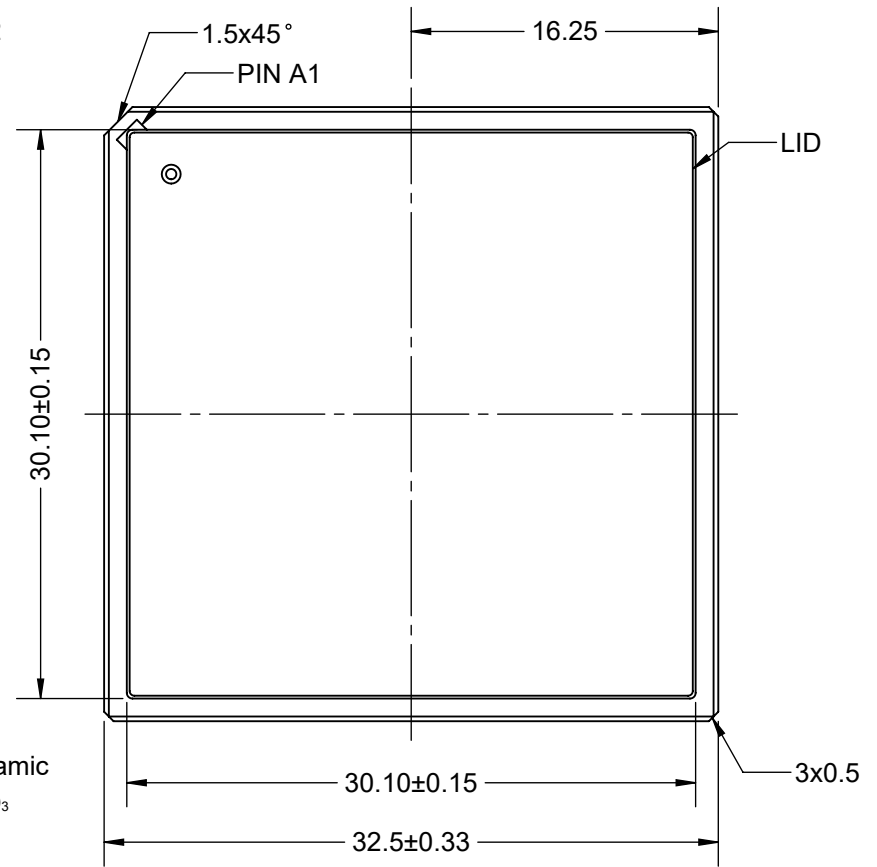

PLATING NOTES:

Ni 2.54um MIN (100 micro-inch MIN)
Au 0.03~0.20um (2 ~ 8 micro-inch)

Notes: (Unless Otherwise Specified).

- 1) DIMENSIONS mm.
- 2) SHOWN WITH COLUMNS.
- 3) SHOWN WITH LID COVER ATTACHED.

PART NUMBER OPTIONS			
PART NUMBER	DUMMY DIE	SOLDER PIN	LID
CCGA624T1.27-FC VAR C	OPTIONAL	YES	SEAM SEAL

APPROVALS	DATE	TopLine®		
DRAWN T.Au	9/11/2024			
ENG M. Hart	9/11/2024	TITLE CCGA624T1.27-FC DAISY CHAIN COLUMN GRID ARRAY		
MFG		SCALE 2.5:1	SIZE A	DRAWING NO. 160052
QA				REV A
CUST				
REVISED		DO NOT SCALE DRAWING		SHEET 1 OF 5

BOTTOM VIEW

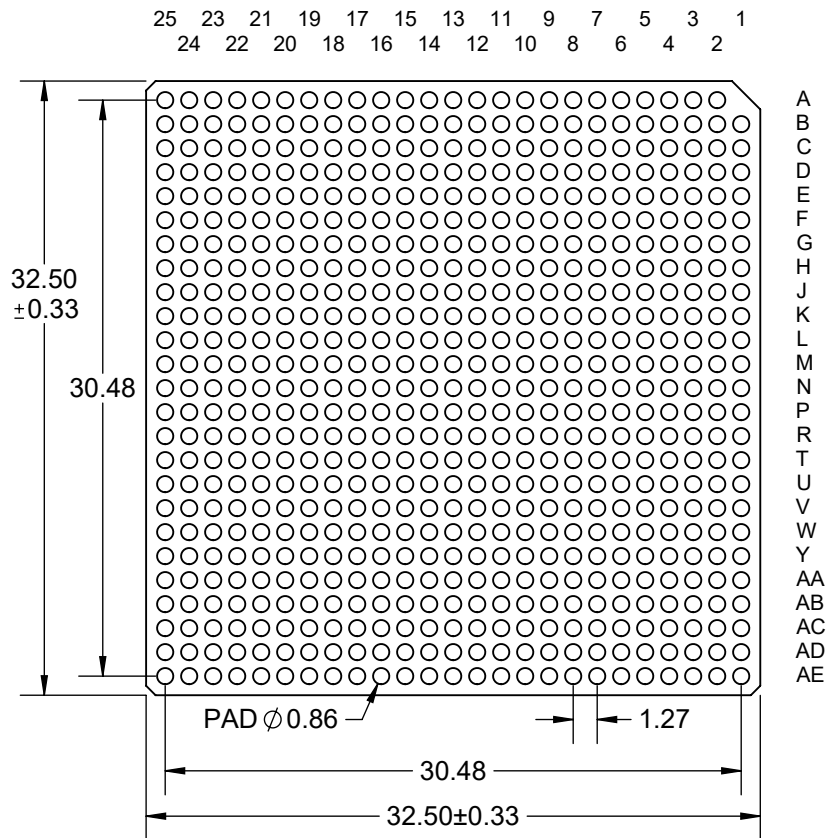

SIDE VIEW

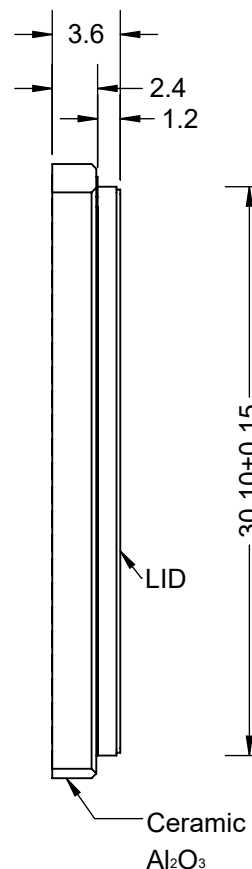

TOP VIEW

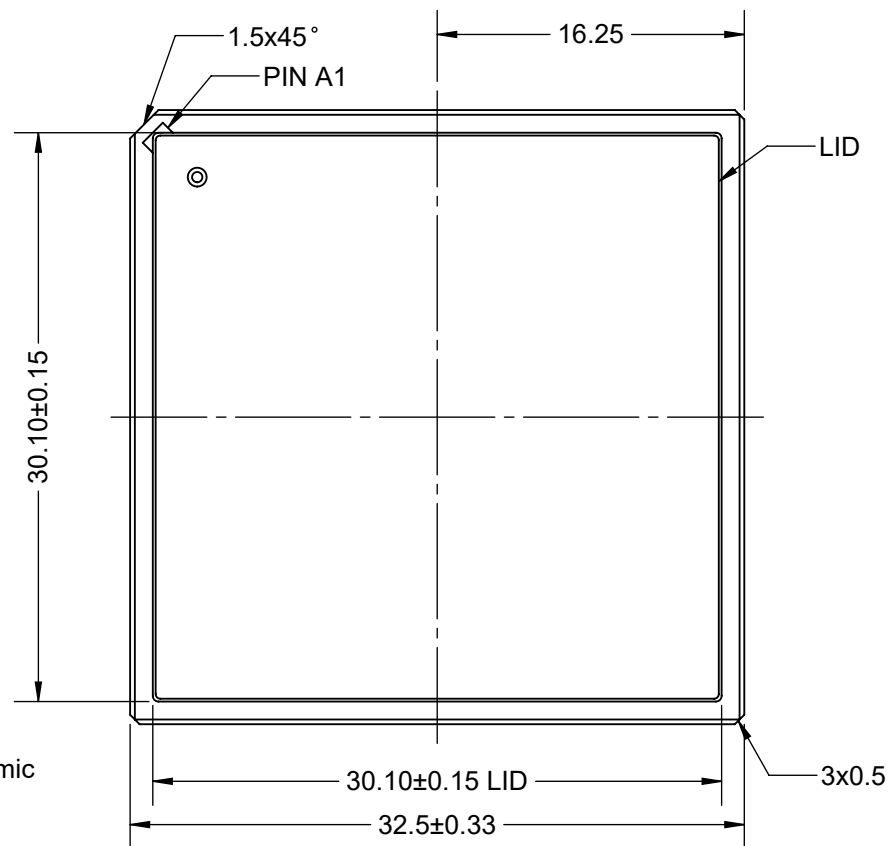

PLATING NOTES:

Ni 2.54um MIN (100 micro-inch MIN)

Au 0.03~0.20um (2 ~ 8 micro-inch)

Notes: (Unless Otherwise Specified).

- 1) DIMENSIONS ARE IN mm.
- 2) SHOWN WITHOUT COLUMNS.
- 3) SHOWN WITH LID COVER ATTACHED.

PART NUMBER OPTIONS			
PART NUMBER	DUMMY DIE	SOLDER PIN	LID
CLGA624T1.27-FC VAR C	OPTIONAL	NONE	SEAM SEAL

APPROVALS	DATE				
DRAWN T.Au	9/11/2024				
ENG M. Hart	9/11/2024	TITLE CCGA624T1.27-FC DAISY CHAIN COLUMN GRID ARRAY			
MFG		SCALE	SIZE	DRAWING NO.	REV
QA		2.5:1	A	160052	A
CUST		DO NOT SCALE DRAWING			SHEET 2 OF 5
REVISED					

SOLDER PIN OPTIONS

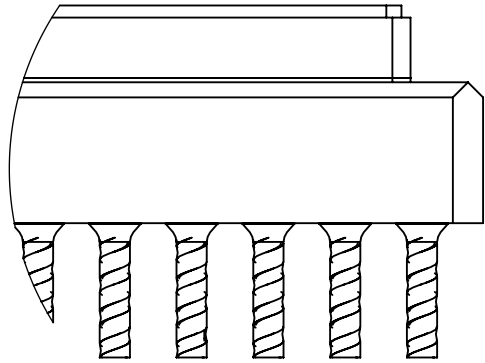
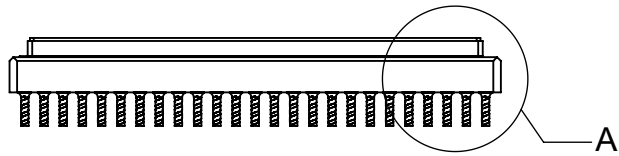

DETAIL A
SCALE 8 : 1

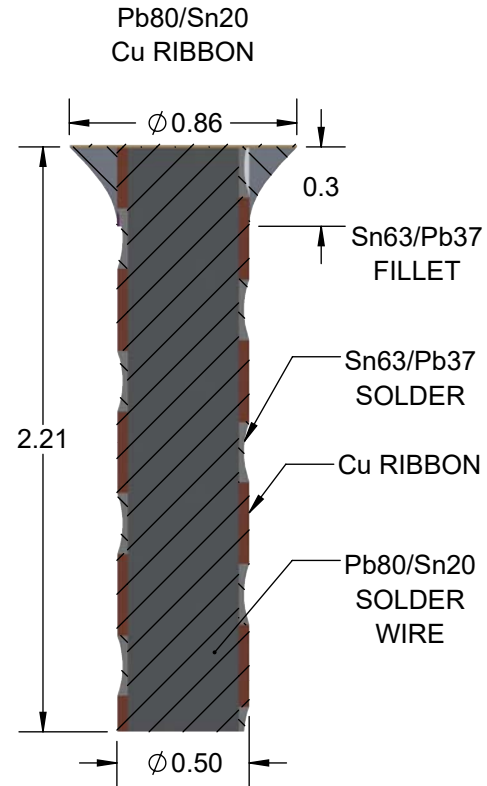

SECTION B-B
SCALE 35 : 1

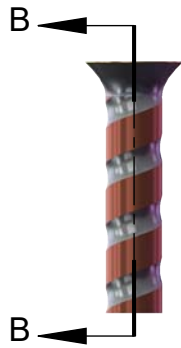

Pb80/Sn20
Cu RIBBON
SCALE 15:1

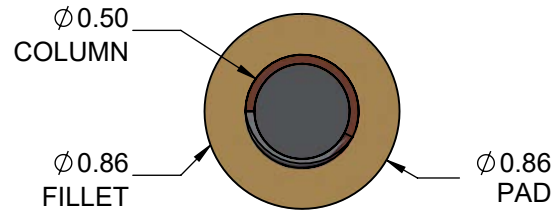

TopLine®			
TITLE CCGA624T1.27-FC DAISY CHAIN COLUMN GRID ARRAY			
SCALE 8:1	SIZE A	DRAWING NO. 160052	REV A
DO NOT SCALE DRAWING			SHEET 3 OF 5

MODEL
CLGA624T1.27-FC VAR C
LID/COVER ATTACHED

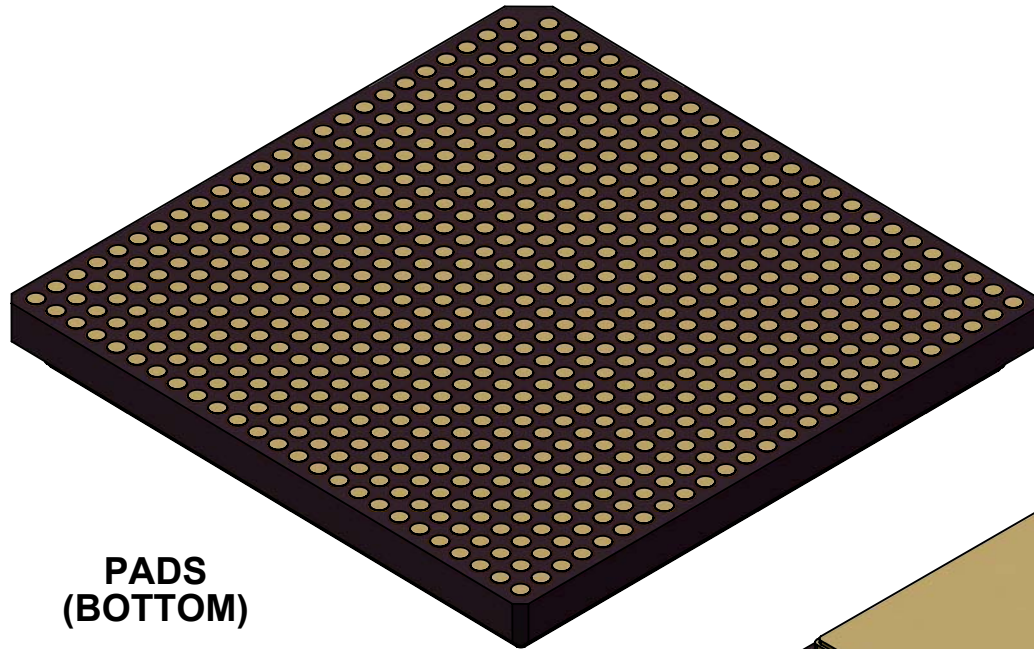

PADS
(BOTTOM)

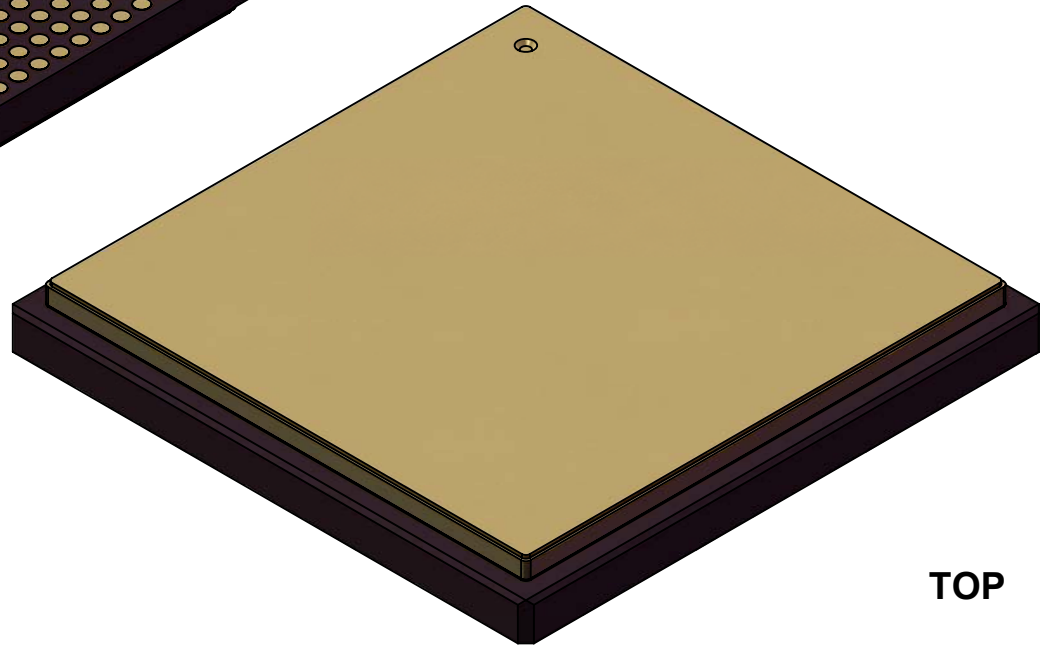

TOP

TopLine®			
TITLE CCGA624T1.27-FC DAISY CHAIN COLUMN GRID ARRAY			
SCALE	SIZE	DRAWING NO.	REV
3:1	A	160052	A
DO NOT SCALE DRAWING			SHEET 4 OF 5

MODEL
CCGA624T1.27-FC VAR C
Pb80/Sn20 COPPER WRAPPED
COLUMNS

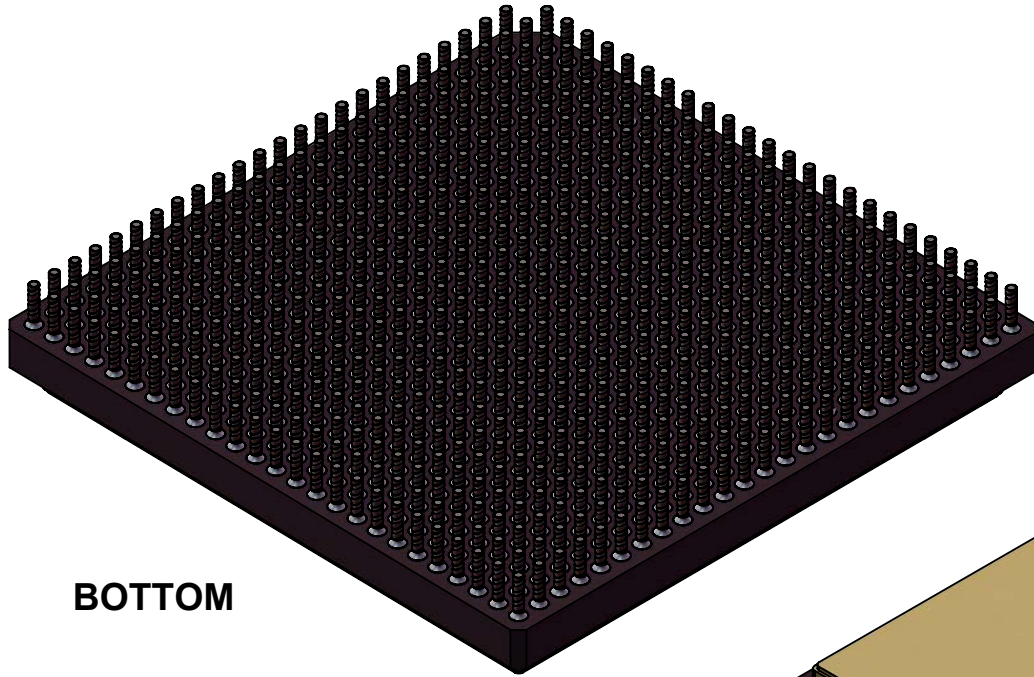

BOTTOM

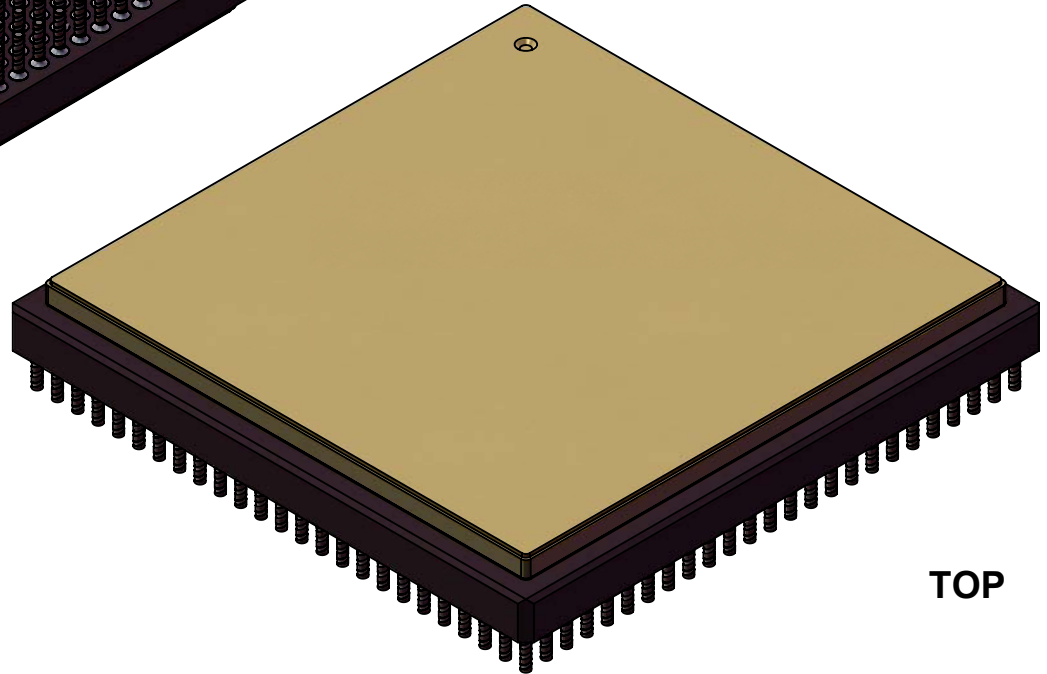

TOP

TopLine[®]

TITLE CCGA624T1.27-FC
DAISY CHAIN COLUMN GRID ARRAY

SCALE 3:1	SIZE A	DRAWING NO. 160052	REV A
--------------	-----------	-----------------------	----------

DO NOT SCALE DRAWING

SHEET 5 OF 5