

### 6 CHCA J9K

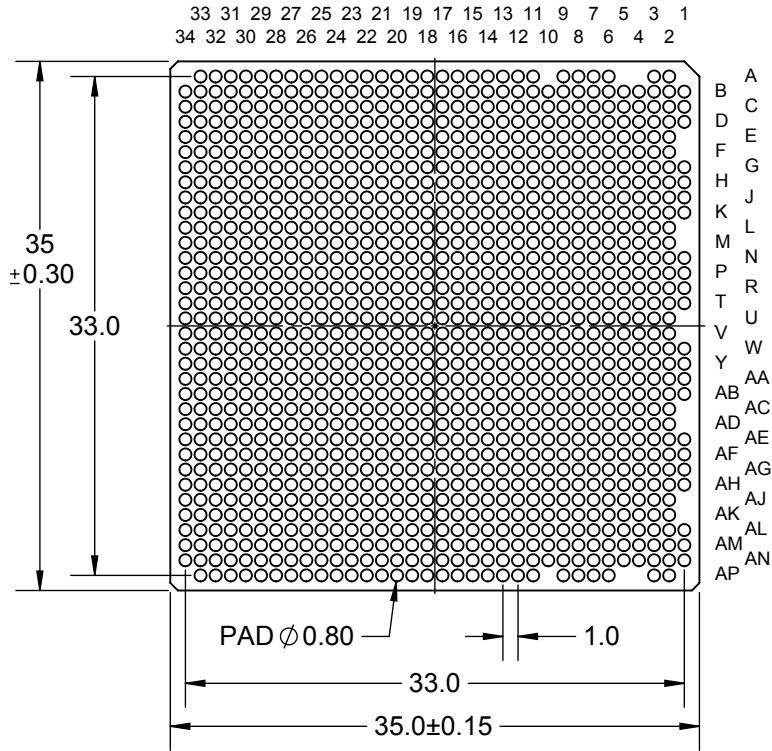

### G89 J9K

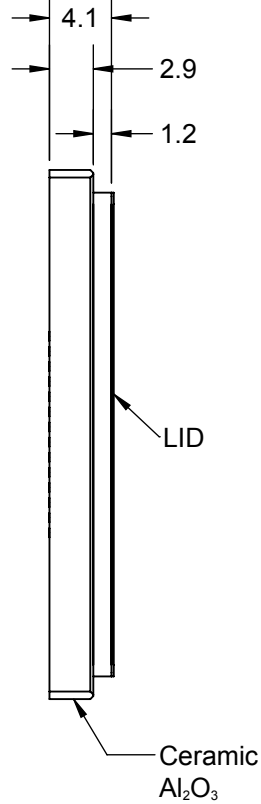

### HCD J9K

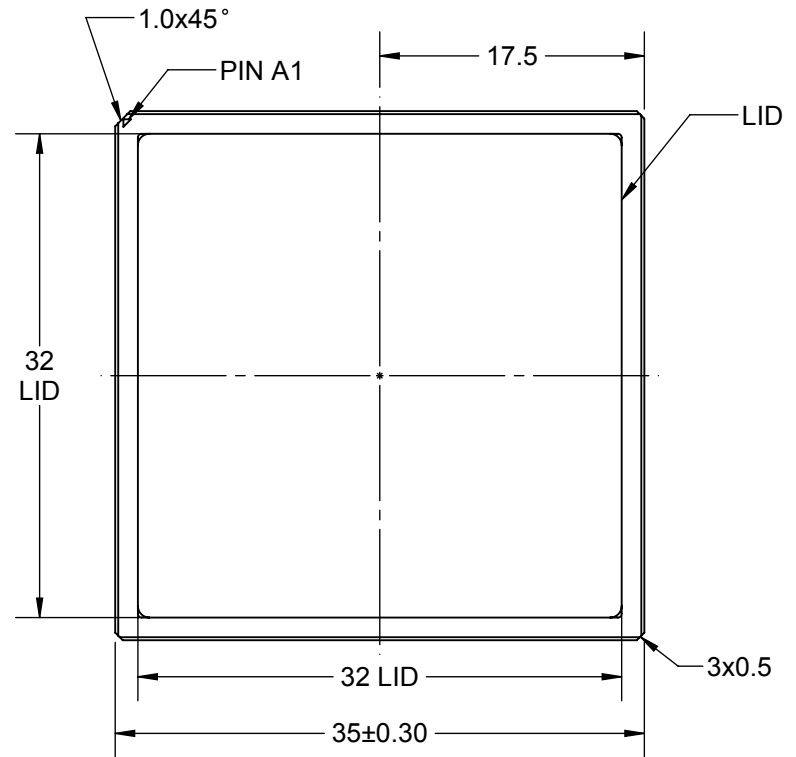

**COLUMNS DEPOPULATED:**

A1, A4, A5, A10, A34, E1, F1, L1, M1, U1, V1,  
AC1, AD1, AJ1, AK1, AP1, AP4, AP5, AP10, AP34.

<b>D5FHBI A69F CDHCBG</b>			
<b>D5FHBI A69F</b>	<b>89</b>	<b>GC @9F D-B</b>	<b>@8</b>
CLGA1136T1.0-DC342D	YES	NONE	YES

- Notes: (Unless Otherwise Specified).  
 1) DIMENSIONS ARE IN mm.  
 2) SHOWN WITHOUT COLUMNS.  
 3) SHOWN WITH LID COVER ATTACHED.

APPROVALS	DATE	<b>TopLine®</b>		
DRAWN T.Au	4/17/2020	TITLE CLGA1136T1.0-DC342D COLUMN GRID ARRAY		
ENG M. Hart	4/17/2020			
MFG		SCALE	SIZE	DRAWING NO.
QA		2:1	A	160142
CUST				REV A
REVISED		DO NOT SCALE DRAWING		SHEET 1 OF 3

85 -GM7 <5 -B'D5 HH9 FB

7 C@ AB'fD5 8LJ-9K

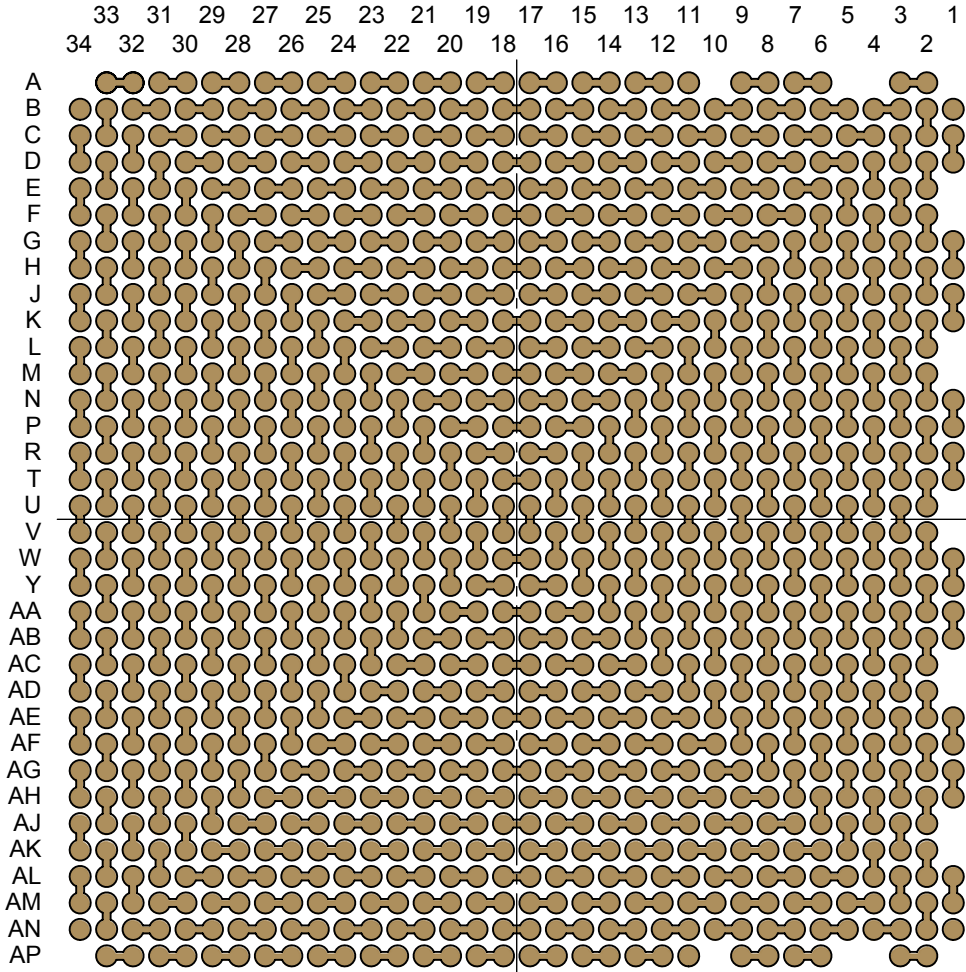

6 CHCA 'L!F5 MJ-9K 98 : FCA 'HCD

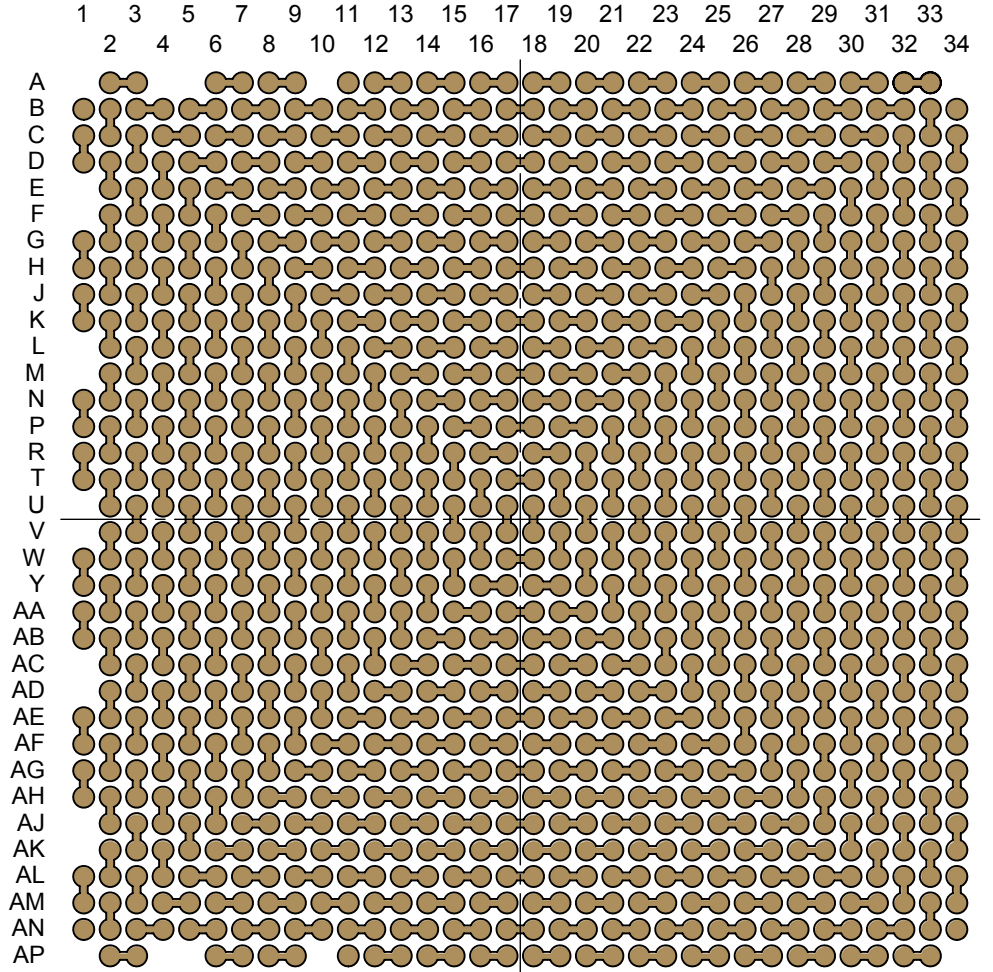

COLUMNS DEPOPULATED:

- A1, A4, A5, A10, A34, E1, F1, L1, M1, U1, V1,
- AC1, AD1, AJ1, AK1, AP1, AP4, AP5, AP10, AP34.



TITLE			
CLGA1136T1.0-DC342D COLUMN GRID ARRAY			
SCALE	SIZE	DRAWING NO.	REV
3.5:1	A	160142	A
DO NOT SCALE DRAWING			SHEET 2 OF 3

AC89@  
7 @ 5 %% \* H%\$!87' ( &&  
@8 '5 HH57 <98

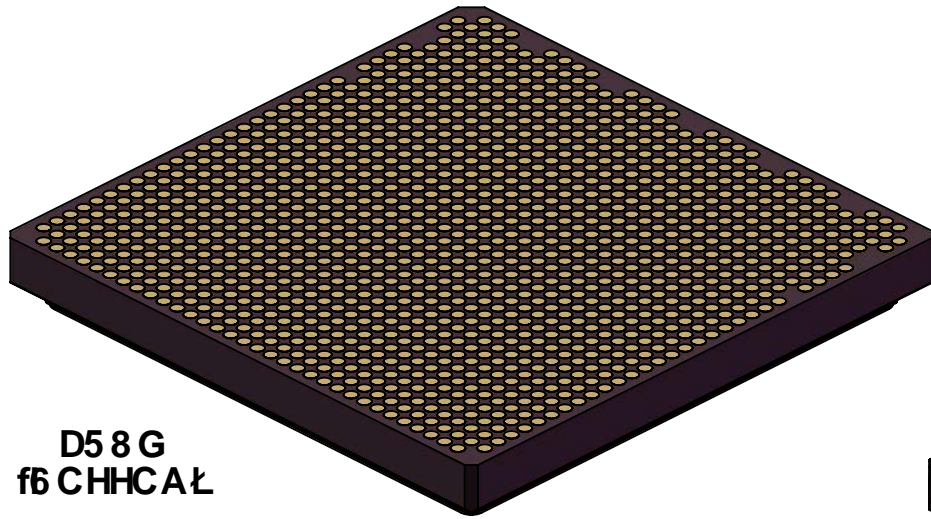

D5 8 G  
f6 CHHCAŁ

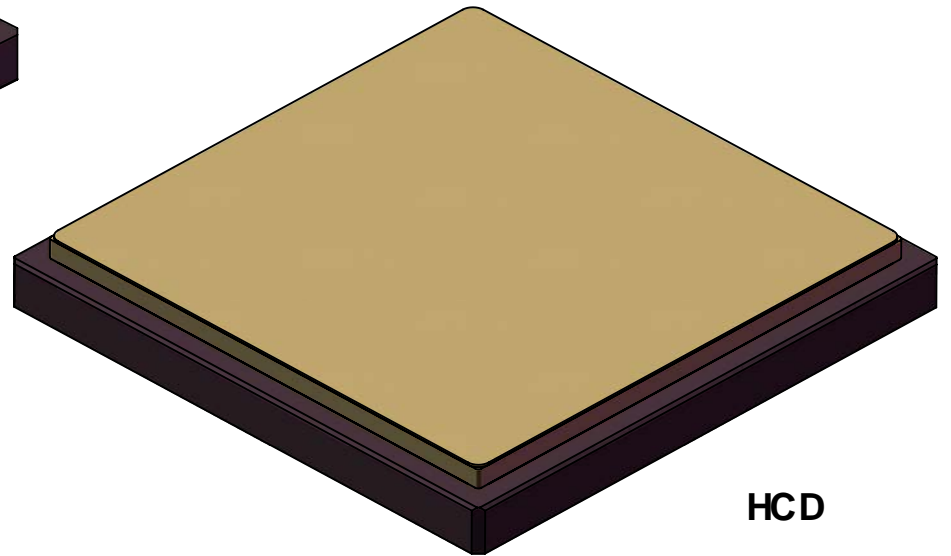

HCD

**TopLine**<sup>®</sup>

TITLE CLGA1136T1.0-DC342D  
COLUMN GRID ARRAY

SCALE 2.5:1	SIZE A	DRAWING NO. 160142	REV A
----------------	-----------	-----------------------	----------

DO NOT SCALE DRAWING

SHEET 3 OF 3