

WIRE BONDING PAD

DETAIL 1

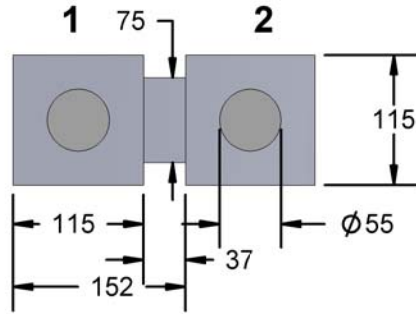

DETAIL 2

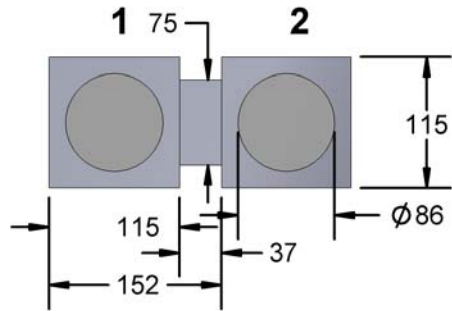

DETAIL 3

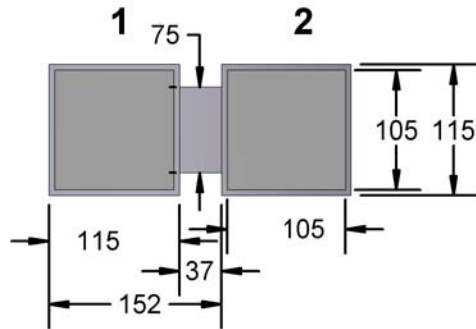

DAISY CHAIN PATTERN PAD VIEW

84 83 82 81 80 79 78 77 76 75 74 73 72 71 70 69 68 67 66 65 64 63 62 61 60 59 58 57

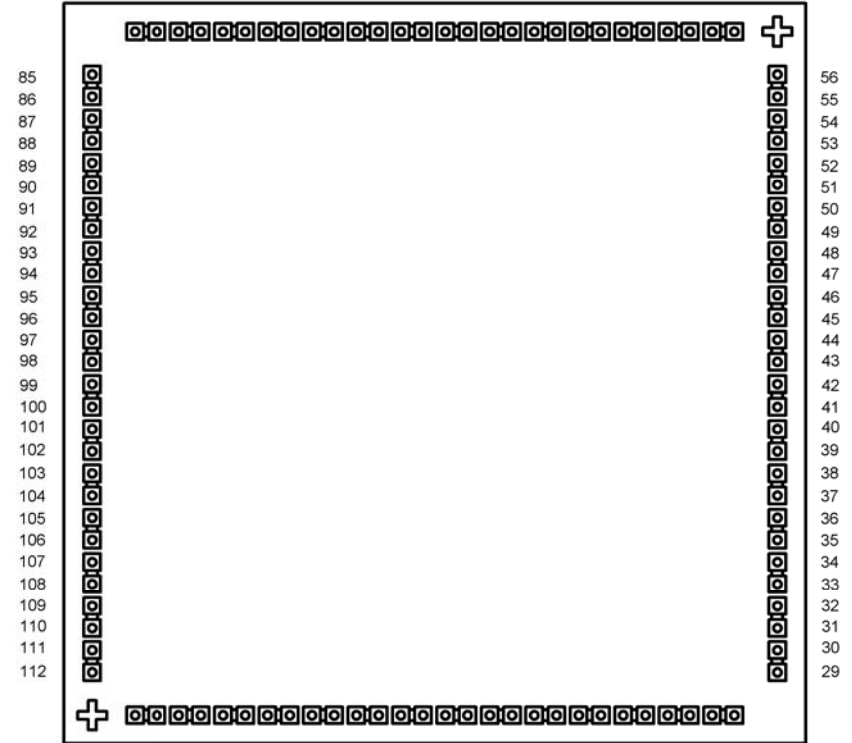

1 2 3 4 5 6 7 8 9 10 11 12 13 14 15 16 17 18 19 20 21 22 23 24 25 26 27 28

NOTES:

- 1) DIMENSIONS IN MICRONS (μM) OR AS SPECIFIED.
- 2) THICKNESS: 635 μm (OTHER AVAILABLE).
- 3) PASSIVATION: NITRIDE 8KA THICKNESS (0.8 μm).
- 4) PACKAGING: STANDARD WAFFLE PACK (TRAY).
- 5) PAD METAL THICKNESS: 10KA (1.0 μm).

PART NUMBER TABLE

PART NUMBER	DIE SIZE	DIE PER WAFER	BOND SITE	DETAIL
FCN112L5A152-DC	5.08mm	340	Ø55 μm	1
FCN112K5A152-DC	5.08mm	340	Ø86 μm	2
FCN112H5A152-DC	5.08mm	340	Ø105 μm SQ	3

APPROVALS	DATE				
DRAWN T. Au	4/27/2018				
ENG M. Hart	4/27/2018	SCALE 15:1	SIZE A	DRAWING NO. 662810	REV A
MFG					
QA					
CUST					
REVISED		DO NOT SCALE DRAWING			SHEET 1 OF 8

OUTLINE DIMENSIONS

BACK SIDE

PAD SIDE

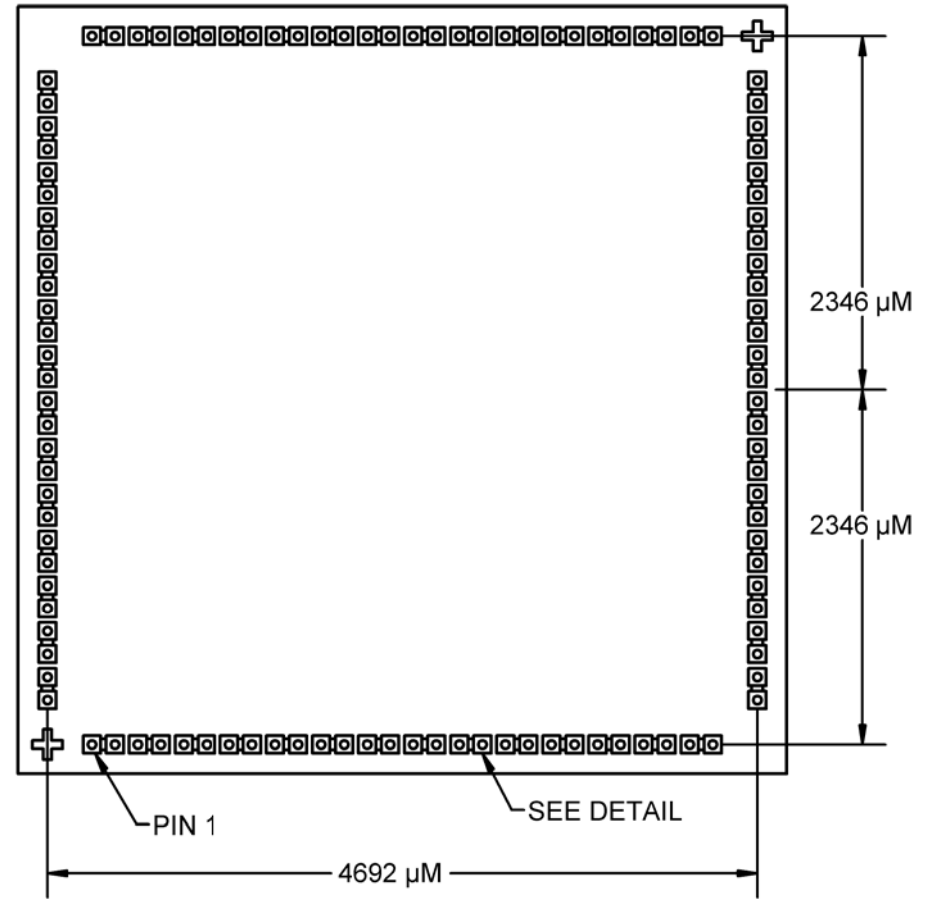
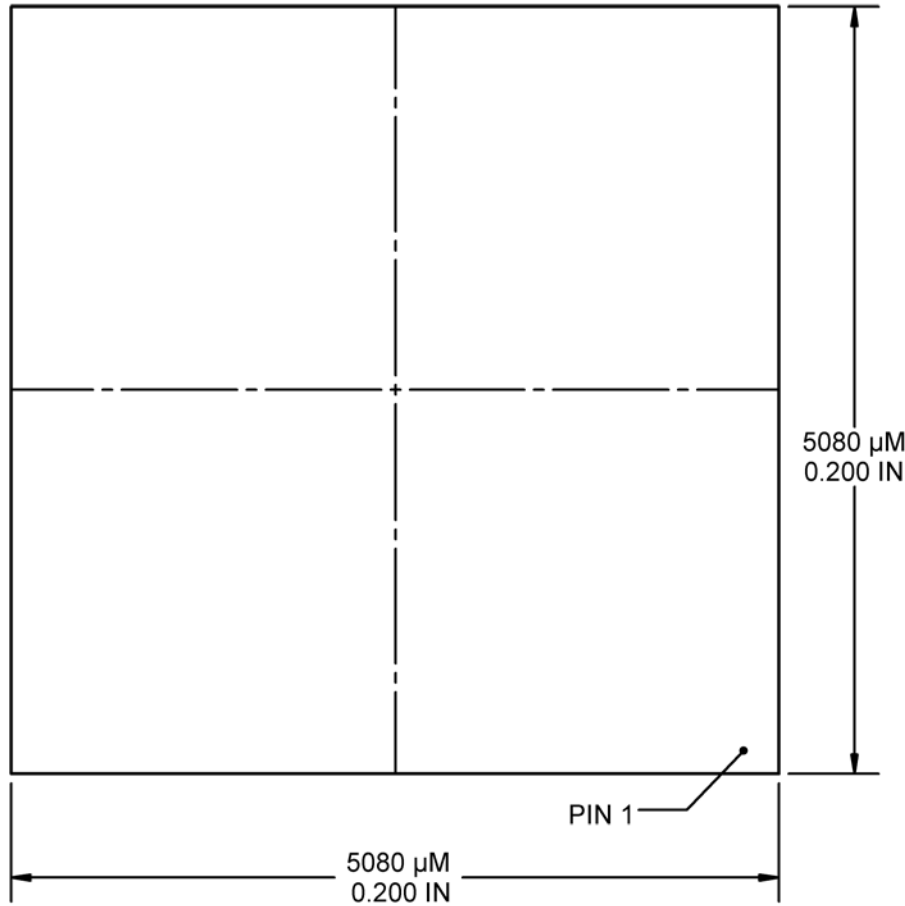

DETAIL 1

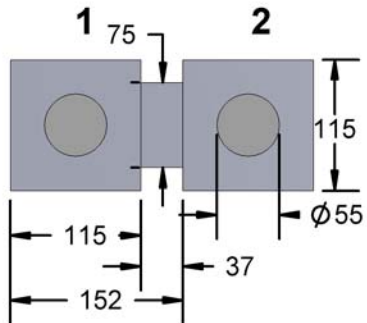

DETAIL 2

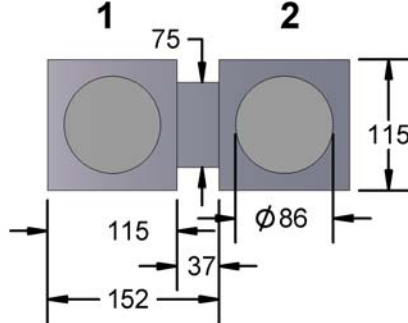

DETAIL 3

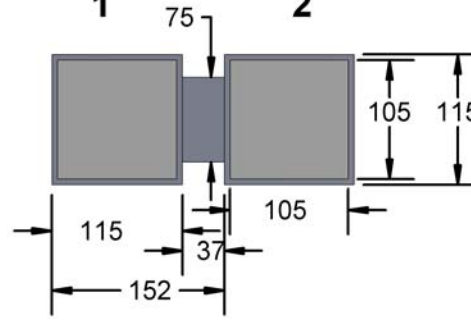

TopLine[®]

TITLE FCN112 - 152 μ m PITCH DAISY CHAIN DIE			
SCALE 17.5:1	SIZE A	DRAWING NO. 662810	REV A
DO NOT SCALE DRAWING			SHEET 2 OF 8

PCB VIEW
SCALE: 3.5/1

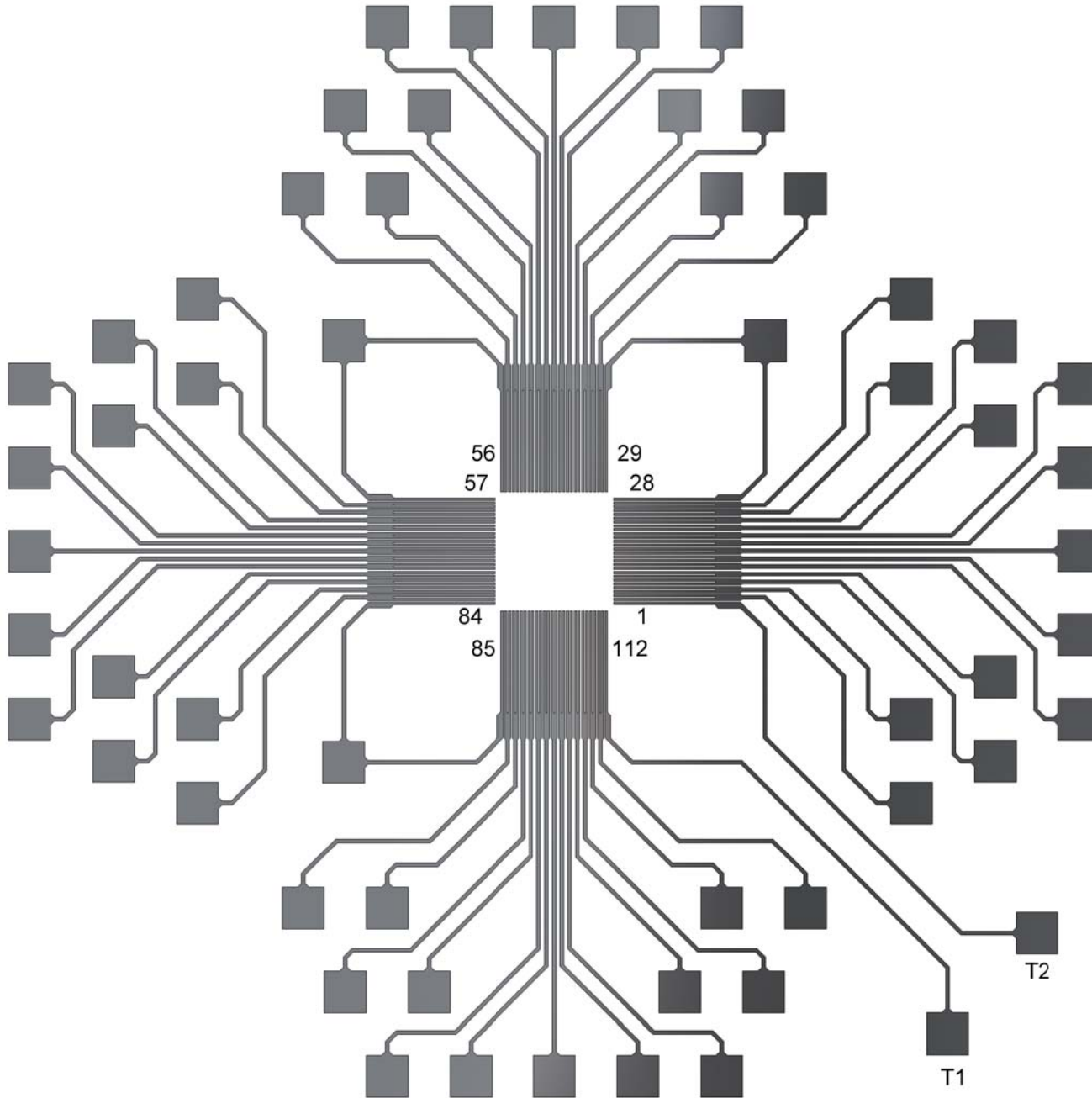

BEFORE BONDING

83 81 79 77 75 73 71 69 67 65 63 61 59 57
84 82 80 78 76 74 72 70 68 66 64 62 60 58

85
86
87
88
89
90
91
92
93
94
95
96
97
98
99
100
101
102
103
104
105
106
107
108
109
110
111
112

56
55
54
53
52
51
50
49
48
47
46
45
44
43
42
41
40
39
38
37
36
35
34
33
32
31
30
29

1 3 5 7 8 10 12 14 16 18 20 22 24 26 28
2 4 6 8 9 11 13 15 17 19 21 23 25 27

TopLine[®]			
TITLE FCN112 - 152um PITCH DAISY CHAIN DIE			
SCALE 10:1	SIZE A	DRAWING NO. 662810	REV A
DO NOT SCALE DRAWING			SHEET 3 OF 8

AFTER BONDING
SCALE: 3.5/1

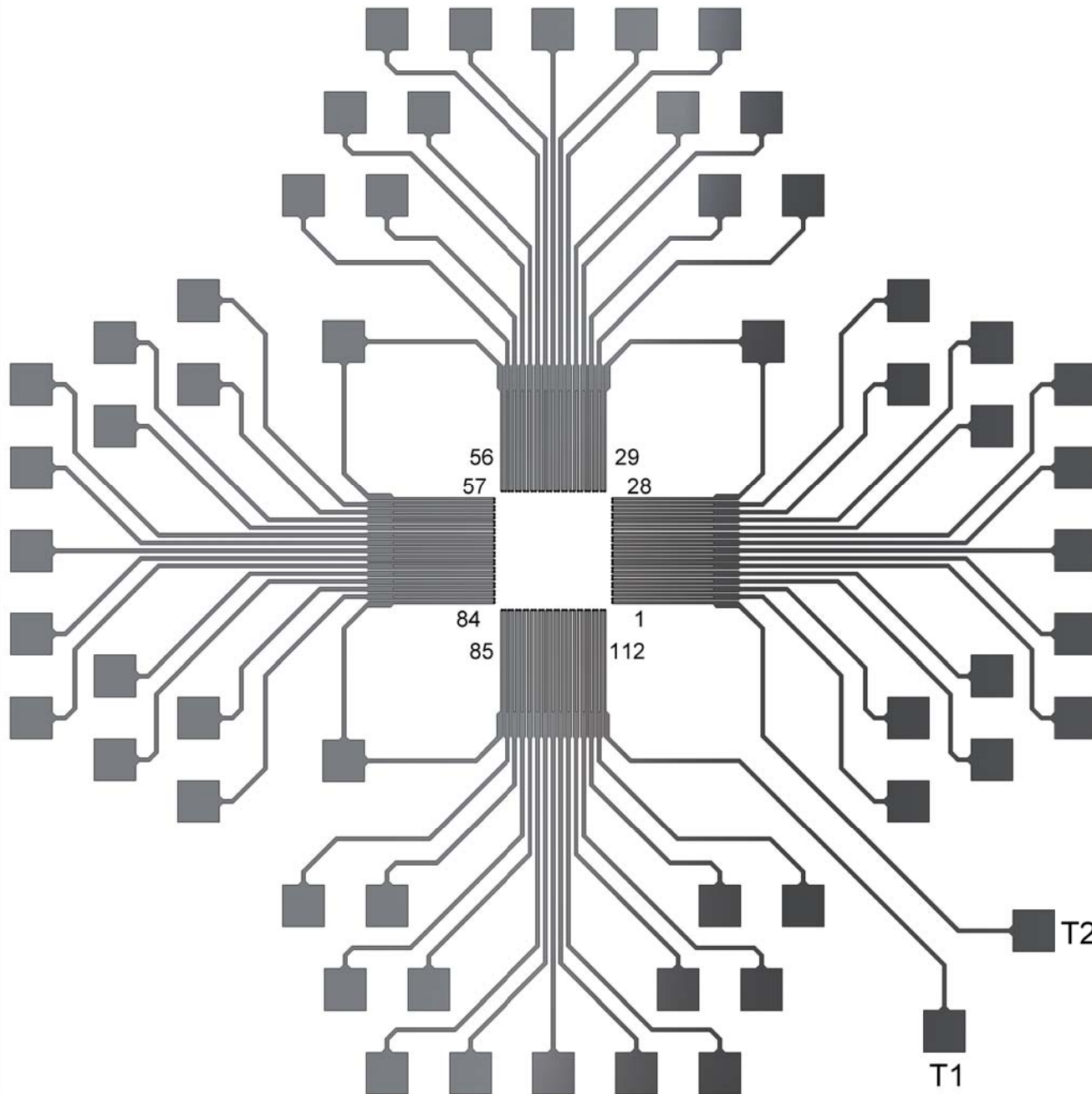

AFTER BONDING

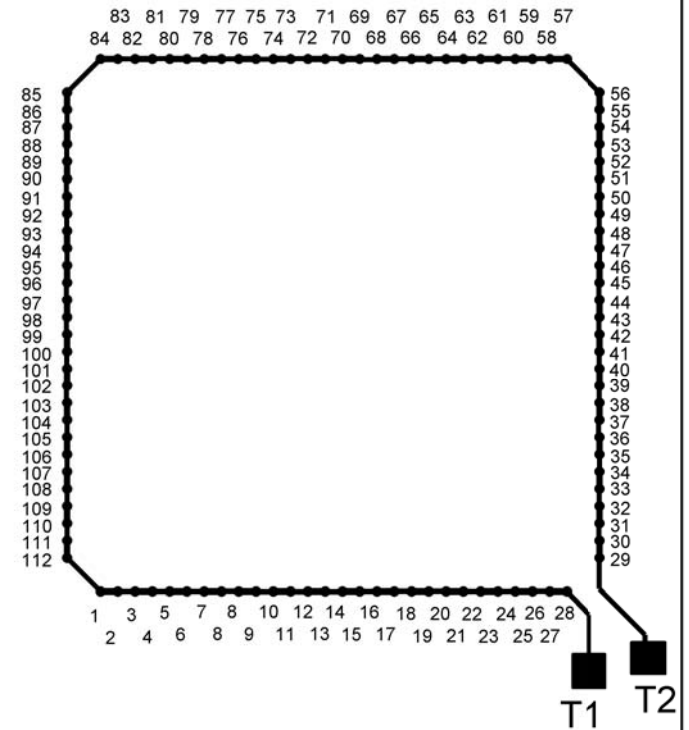

TopLine[®]			
TITLE FCN112 - 152um PITCH DAISY CHAIN DIE			
SCALE 10:1	SIZE A	DRAWING NO. 662810	REV A
DO NOT SCALE DRAWING			SHEET 4 OF 8

PAD LOCATION DIMENSION MICRON (μM)

- NOTES:
 1) DIMENSIONS MICRONS (μM).
 2) X=0, Y=0 IS CENTER OF DIE.
 3) SEE NET LIST PAGE 7.

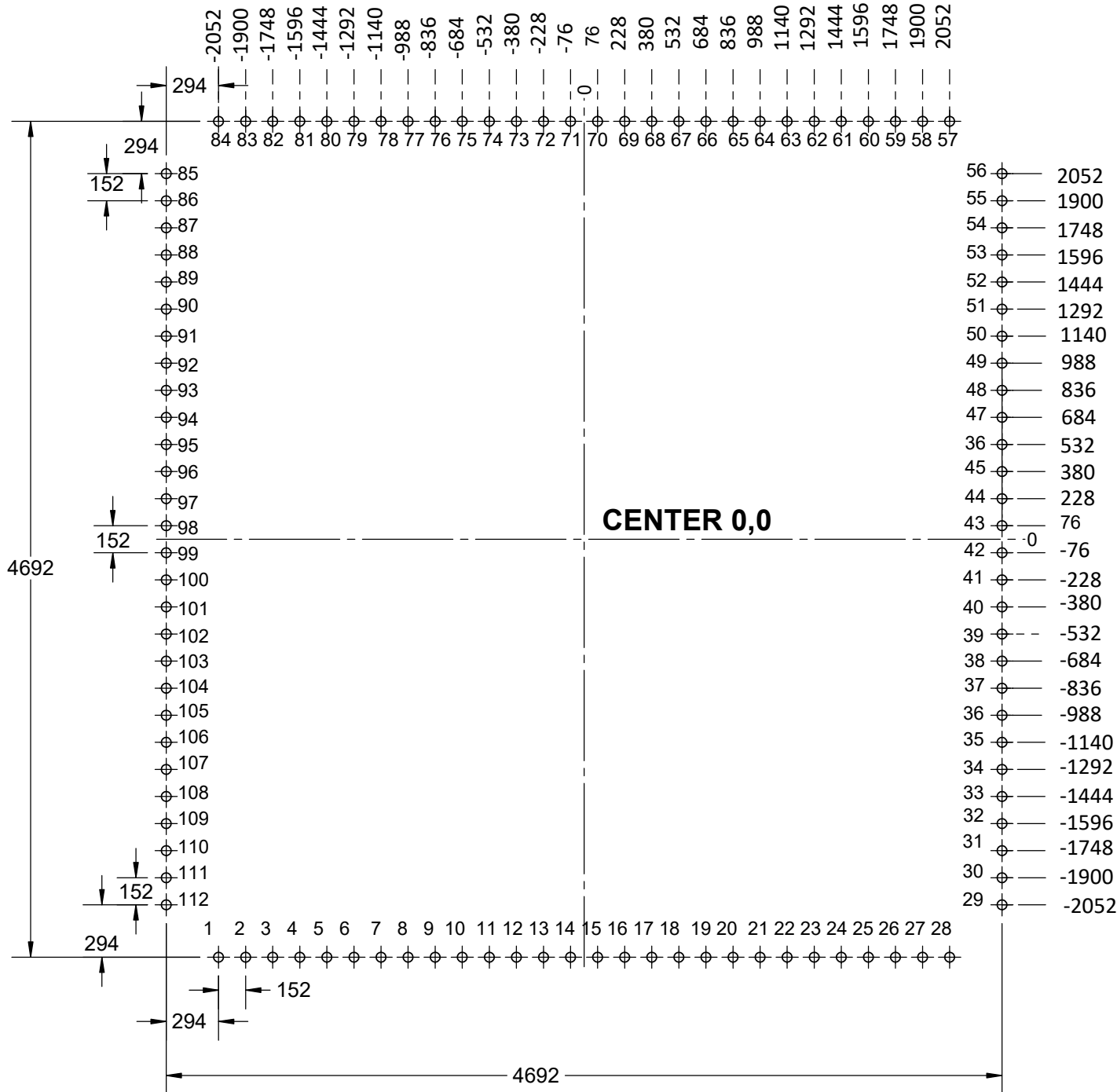

TopLine®			
TITLE FCN112 - 152um PITCH DAISY CHAIN DIE			
SCALE 10:1	SIZE A	DRAWING NO. 662810	REV A
DO NOT SCALE DRAWING			SHEET 5 OF 8

BONDING MAP SEE NET LIST (PAGE 6)

84 83 82 81 80 79 78 77 76 75 74 73 72 71 70 69 68 67 66 65 64 63 62 61 60 59 58 57

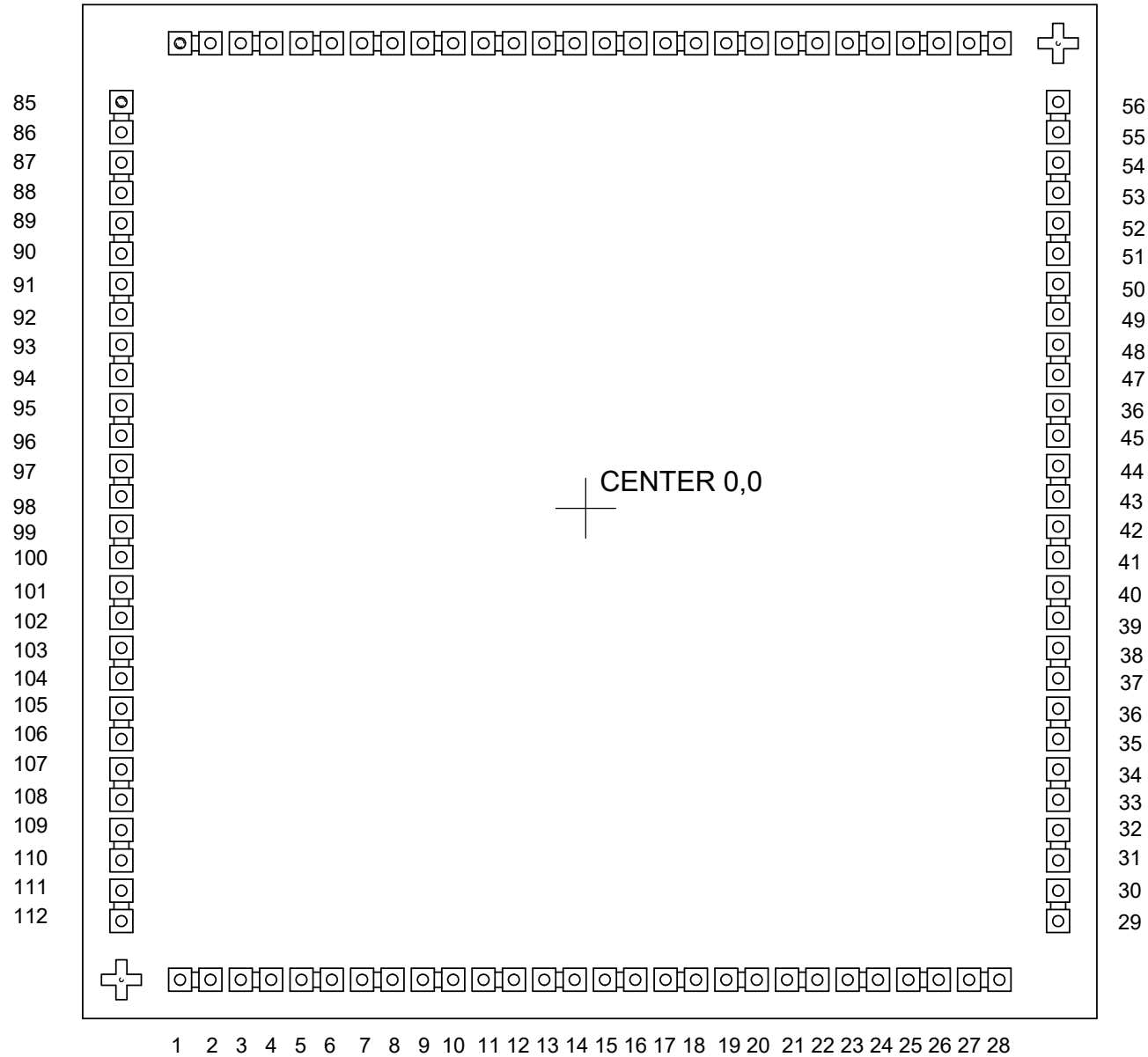

85
86
87
88
89
90
91
92
93
94
95
96
97
98
99
100
101
102
103
104
105
106
107
108
109
110
111
112

56
55
54
53
52
51
50
49
48
47
36
45
44
43
42
41
40
39
38
37
36
35
34
33
32
31
30
29

TopLine [®]			
TITLE FCN112 - 152um PITCH DAISY CHAIN DIE			
SCALE 25:1	SIZE A	DRAWING NO. 662810	REV A
DO NOT SCALE DRAWING			SHEET 6 OF 8

FCN112 NET LIST
MICRON (μM)
(0,0) LOCATED AT THE CENTER OF THE DIE

PIN#	X	Y
1	-2052	-2346
2	-1900	-2346
3	-1748	-2346
4	-1596	-2346
5	-1444	-2346
6	-1292	-2346
7	-1140	-2346
8	-988	-2346
9	-836	-2346
10	-684	-2346
11	-532	-2346
12	-380	-2346
13	-228	-2346
14	-76	-2346
15	76	-2346
16	228	-2346
17	380	-2346
18	532	-2346
19	684	-2346
20	836	-2346
21	988	-2346
22	1140	-2346
23	1292	-2346
24	1444	-2346
25	1596	-2346
26	1748	-2346
27	1900	-2346
28	2052	-2346

PIN#	X	Y
29	2346	-2052
30	2346	-1900
31	2346	-1748
32	2346	-1596
33	2346	-1444
34	2346	-1292
35	2346	-1140
36	2346	-988
37	2346	-836
38	2346	-684
39	2346	-532
40	2346	-380
41	2346	-228
42	2346	-76
43	2346	76
44	2346	228
45	2346	380
46	2346	532
47	2346	684
48	2346	836
49	2346	988
50	2346	1140
51	2346	1292
52	2346	1444
53	2346	1596
54	2346	1748
55	2346	1900
56	2346	2052

PIN#	X	Y
57	2052	2346
58	1900	2346
59	1748	2346
60	1596	2346
61	1444	2346
62	1292	2346
63	1140	2346
64	988	2346
65	836	2346
66	684	2346
67	532	2346
68	380	2346
69	228	2346
70	76	2346
71	-76	2346
72	-228	2346
73	-380	2346
74	-532	2346
75	-684	2346
76	-836	2346
77	-988	2346
78	-1140	2346
79	-1292	2346
80	-1444	2346
81	-1596	2346
82	-1748	2346
83	-1900	2346
84	-2052	2346

PIN#	X	Y
85	-2346	2052
86	-2346	1900
87	-2346	1748
88	-2346	1596
89	-2346	1444
90	-2346	1292
91	-2346	1140
92	-2346	988
93	-2346	836
94	-2346	684
95	-2346	532
96	-2346	380
97	-2346	228
98	-2346	76
99	-2346	-76
100	-2346	-228
101	-2346	-380
102	-2346	-532
103	-2346	-684
104	-2346	-836
105	-2346	-988
106	-2346	-1140
107	-2346	-1292
108	-2346	-1444
109	-2346	-1596
110	-2346	-1748
111	-2346	-1900
112	-2346	-2052

NOTES:
1) DIMENSIONS IN MICRON (μM).
2) X = 0, Y = 0 IS CENTER OF DIE.

			
TITLE FCN112 - 152um PITCH DAISY CHAIN DIE			
SCALE 10:1	SIZE A	DRAWING NO. 662810	REV A
DO NOT SCALE DRAWING			SHEET 7 OF 8

PART NUMBERING SYSTEM

FCN

112

H

5

A

152

- OPTION

- DC

- PACKING

BONDING DIE

FCN = SINGLE DIE
 FCWN = UNSAWN WAFER
 5" (125mm)

NBR BOND PADS

PADS	DIE ARRAY	SIZE
112	1X	5MM
224	4X	10MM
336	9X	15MM
448	16X	20MM

PAD

L = ϕ 55 μ M
 K = ϕ 86 μ M
 H = 105 μ M SQ

DIE SIZE

CODE	MM	MIL
5	5.08	200
10	10.16	400
15	15.24	600
20	20.32	800

PAD MATERIAL

A = Al98, Si1.0 Cu1.0
 THICKNESS 10KA

PAD PITCH

μ M

OPTIONS

DIE THINNING		
CODE	μ M	INCH
NONE	635 μ M	.025"
BG530	530 μ M	.021"
BG430	430 μ M	.017"
BG360	360 μ M	.014"
BG250	250 μ M	.010"
BG200	200 μ M	.008"
BG150	150 μ M	.006"
BG100	100 μ M	.004"

OTHER THICKNESS AVAILABLE

DAISY CHAIN

PACKAGING

BLANK = TRAY (STANDARD)

SIZE	TRAY	QTY
5MM	2-INCH	36 PCS
10MM	4-INCH	49 PCS
15MM	4-INCH	25 PCS
20MM	4-INCH	9 PCS



TITLE FCN112 - 152um PITCH DAISY CHAIN DIE			
SCALE 10:1	SIZE A	DRAWING NO. 662810	REV A
DO NOT SCALE DRAWING		SHEET 8 OF 8	