

TOP

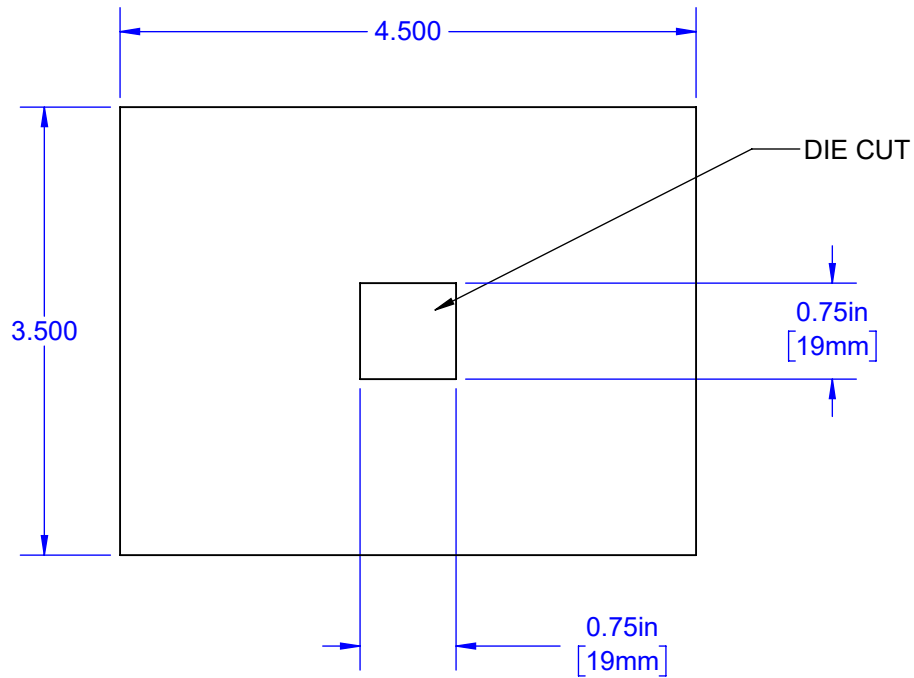

EDGE

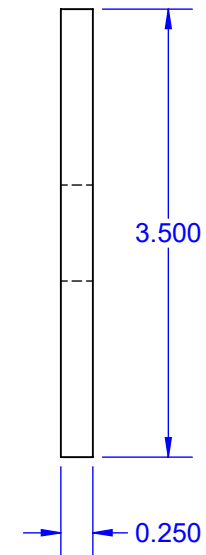

SIDE

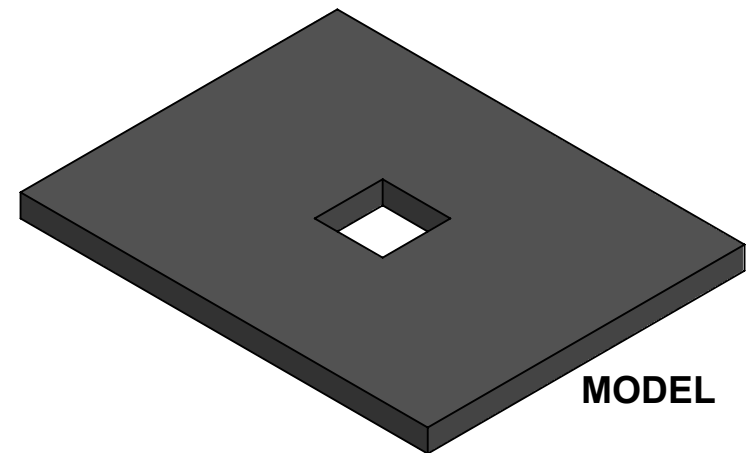
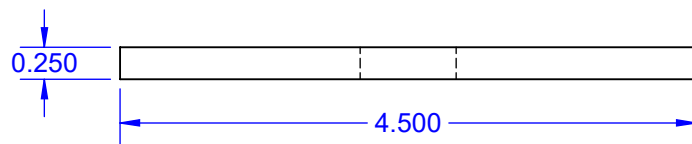

MODEL

Notes: (Unless Otherwise Specified).

- 1) SURFACE RESISTIVITY: $10^3 \Omega$ TO $10^6 \Omega$ PER SQUARE.
- 2) DENSE CONDUCTIVE FOAM.
- 3) DENSITY 2.0 PFC Min.
- 4) DIMENSIONS INCH (mm).

TopLine®

TITLE EC1-FOAM INSERT 19mm
HIGH DENSITY FOAM

SCALE 2:3	SIZE A	DRAWING NO. 090025	REV A
--------------	-----------	-----------------------	----------

DO NOT SCALE DRAWING

SHEET 1 OF 1