

TOP

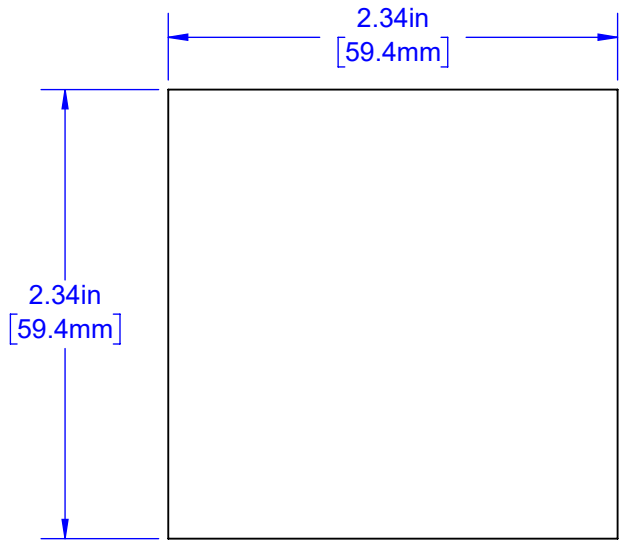

EDGE

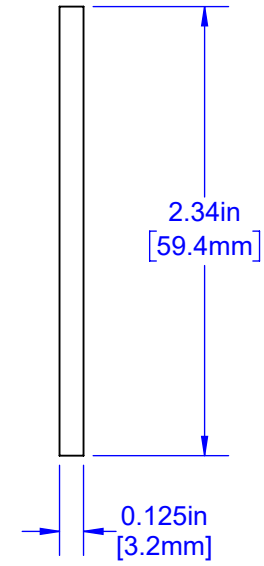

SIDE

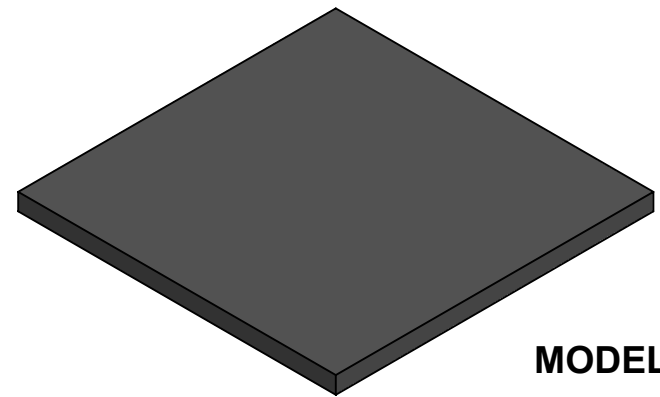
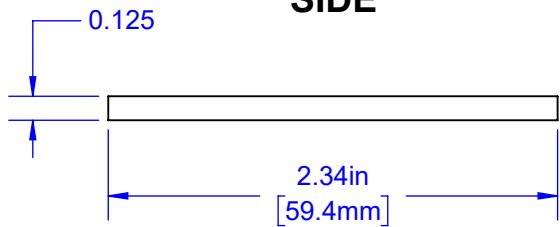

MODEL

Notes: (Unless Otherwise Specified).

- 1) SURFACE RESISTIVITY: $10^3 \Omega$ TO $10^6 \Omega$ PER SQUARE.
- 2) SOFT CONDUCTIVE FOAM.
- 3) DENSITY 1.7 PFC Min.
- 4) DIMENSIONS INCHES [mm].

APPROVALS	DATE	TopLine[®]			
DRAWN T. Au	7/17/2021				
ENG M. Hart	7/17/2021	TITLE FOAM-SOFT-2.34-A LOW DENSITY FOAM			
MFG		SCALE 1:1	SIZE A	DRAWING NO. 090011	REV A
QA					
CUST		DO NOT SCALE DRAWING			SHEET 1 OF 1
REVISED					