

SECTION A-A
SCALE 4 : 1

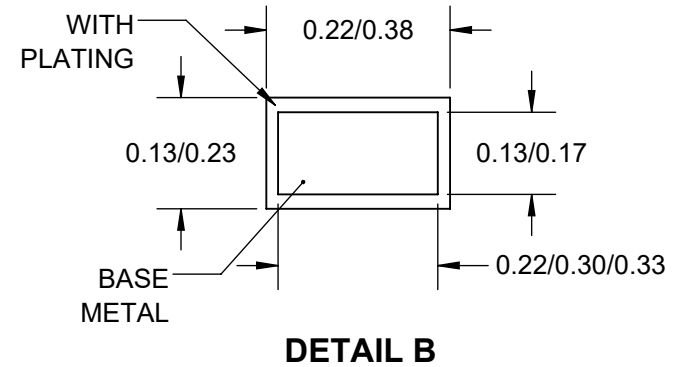
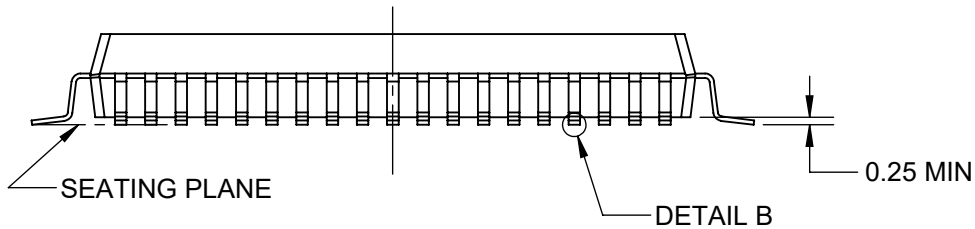
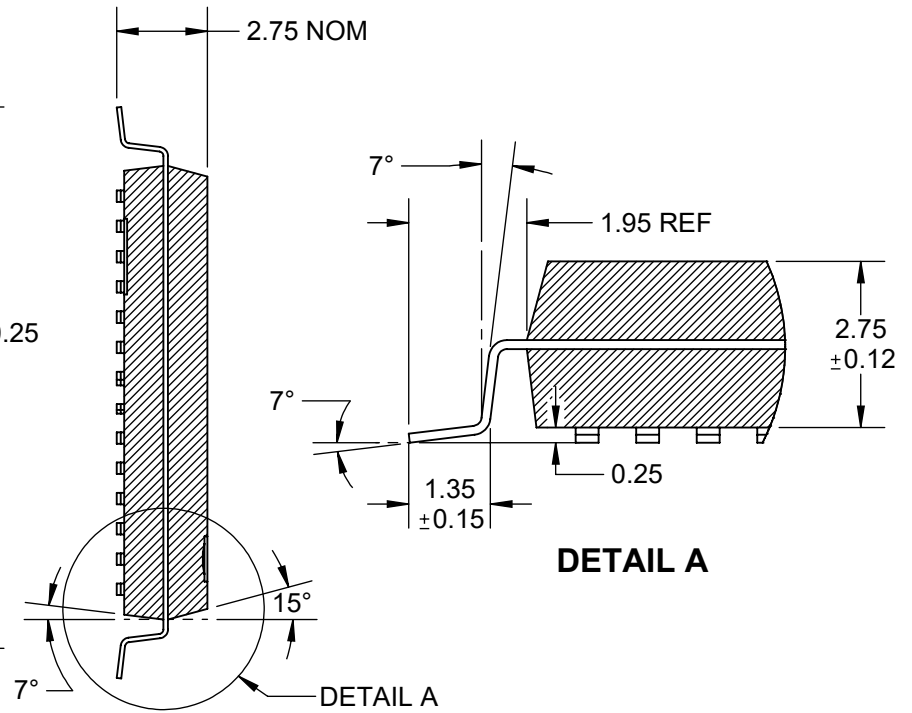
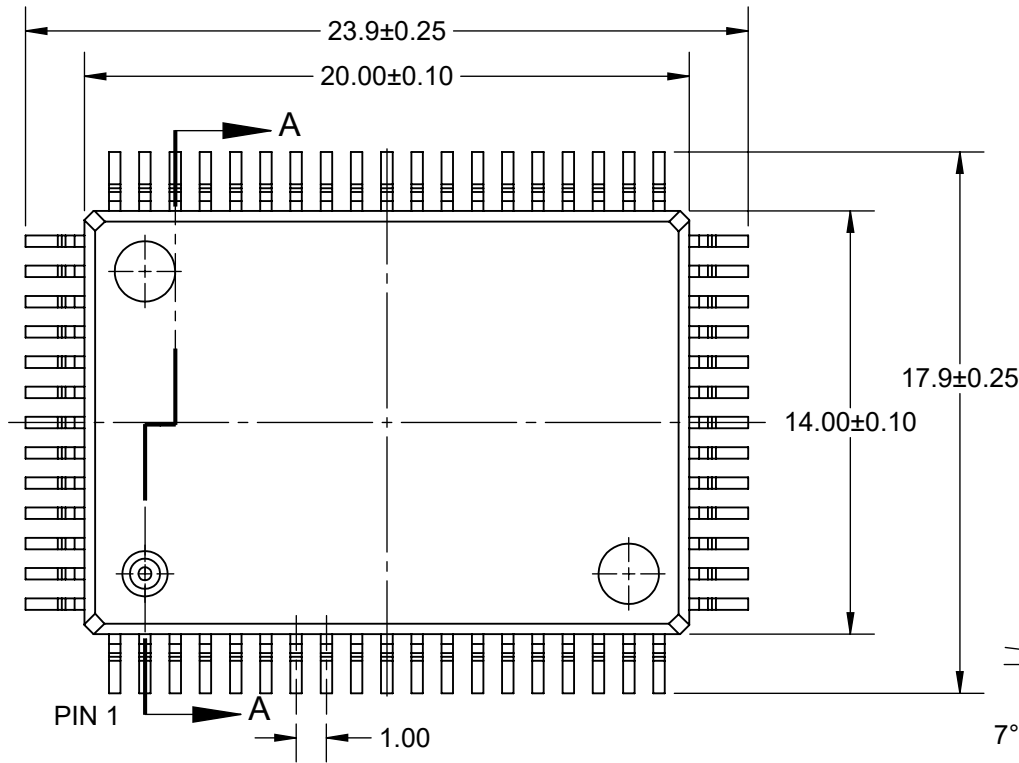

Notes: (Unless Otherwise Specified)

- 1) DIMENSIONS mm.
- 2) BODY PLASTIC, SEMICONDUCTOR GRADE.
- 3) LEAD FRAME COPPER. C-194 F/H.

APPROVALS	DATE	TopLine®			
DRAWN T. Au	12/2/2019				
ENG M. Hart	12/2/2019	TITLE QFP64T40-3.9 QUAD FLAT PLACK			
MFG		SCALE	SIZE	DRAWING NO.	REV
QA		4:1	A	181640	A
CUST		DO NOT SCALE DRAWING			SHEET 1 OF 4
REVISED					

MODEL

TOP

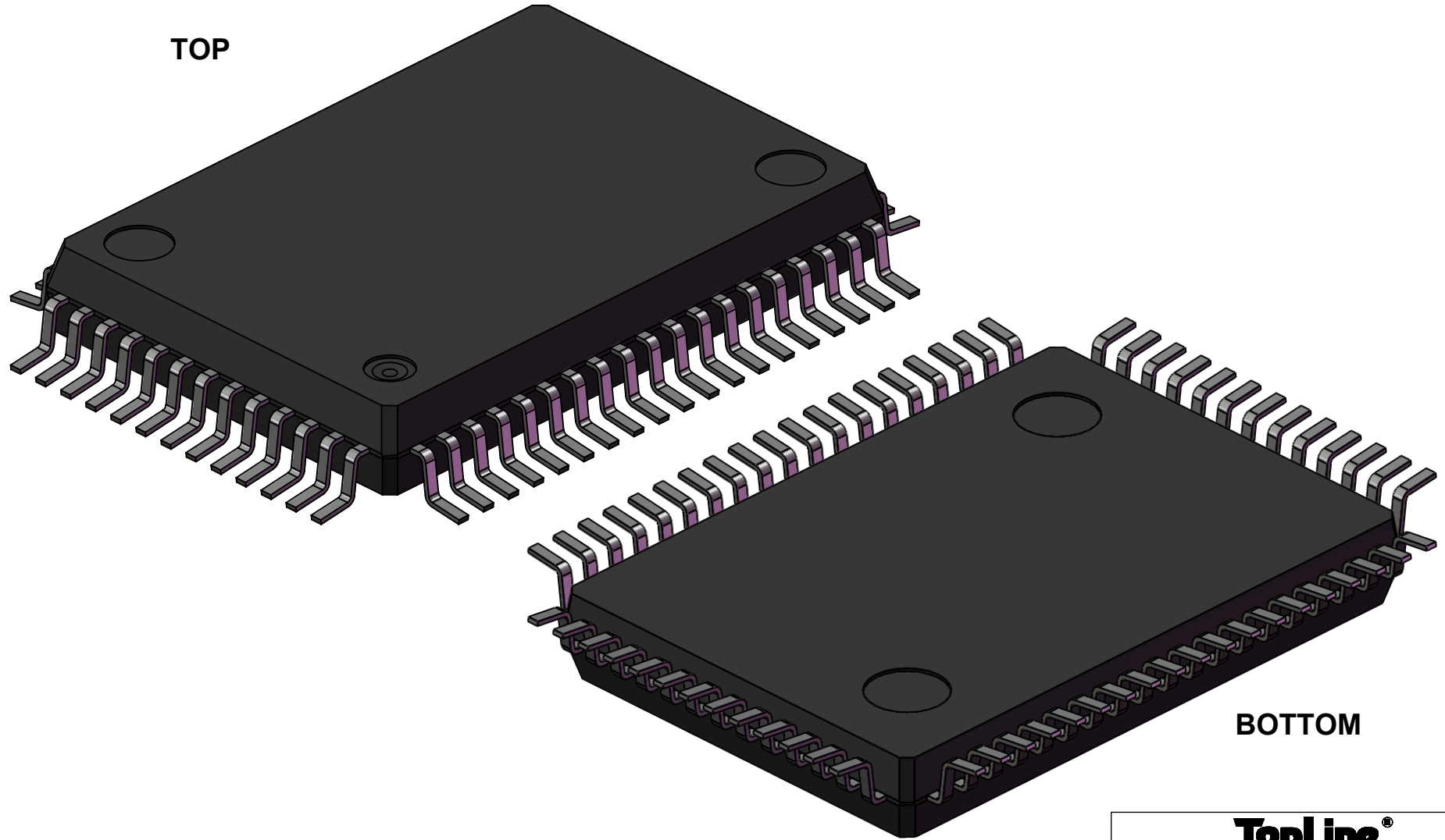

BOTTOM

TopLine[®]			
TITLE		QFP64T40-3.9 QUAD FLAT PACK	
SCALE	SIZE	DRAWING NO.	REV
6:1	A	181640	A
DO NOT SCALE DRAWING			SHEET 2 OF 4

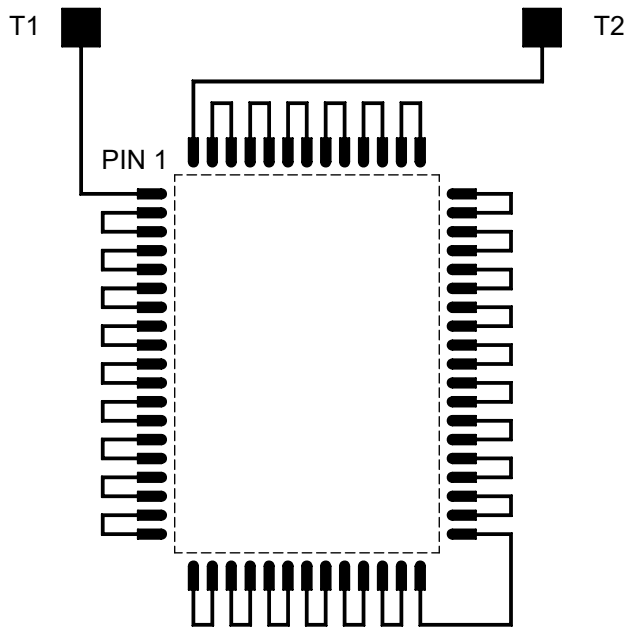

**RECOMMENDED
PCB PADS**

**DAISY CHAIN
OPTIONAL**

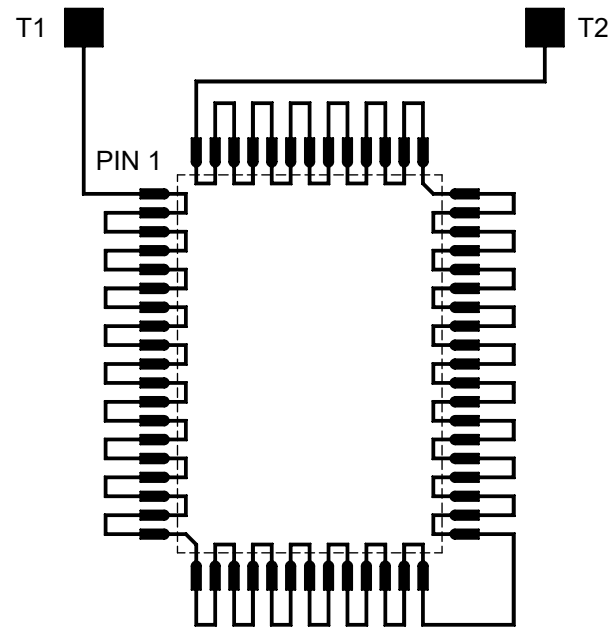

**AFTER MOUNTING
ON PCB**

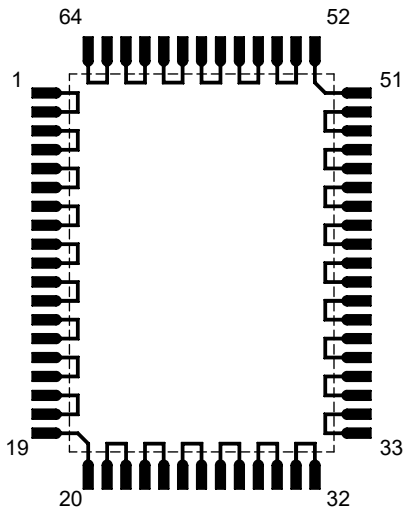

VIEW FROM TOP

DAISY CHAIN NET LIST			
PINS	PINS	PINS	PINS
1 ~ 2	17 ~ 18	33 ~ 34	49 ~ 50
3 ~ 4	19 ~ 20	35 ~ 36	51 ~ 52
5 ~ 6	21 ~ 22	37 ~ 38	53 ~ 54
7 ~ 8	23 ~ 24	39 ~ 40	55 ~ 56
9 ~ 10	25 ~ 26	41 ~ 42	57 ~ 58
11 ~ 12	27 ~ 28	43 ~ 44	59 ~ 60
13 ~ 14	29 ~ 30	45 ~ 46	61 ~ 62
15 ~ 16	31 ~ 32	47 ~ 48	63 ~ 64

TopLine®			
TITLE QFP64T40-3.9 QUAD FLAT PLACK			
SCALE 2.5:1	SIZE A	DRAWING NO. 181640	REV A
DO NOT SCALE DRAWING			SHEET 3 OF 4

PART NUMBERING SYSTEM

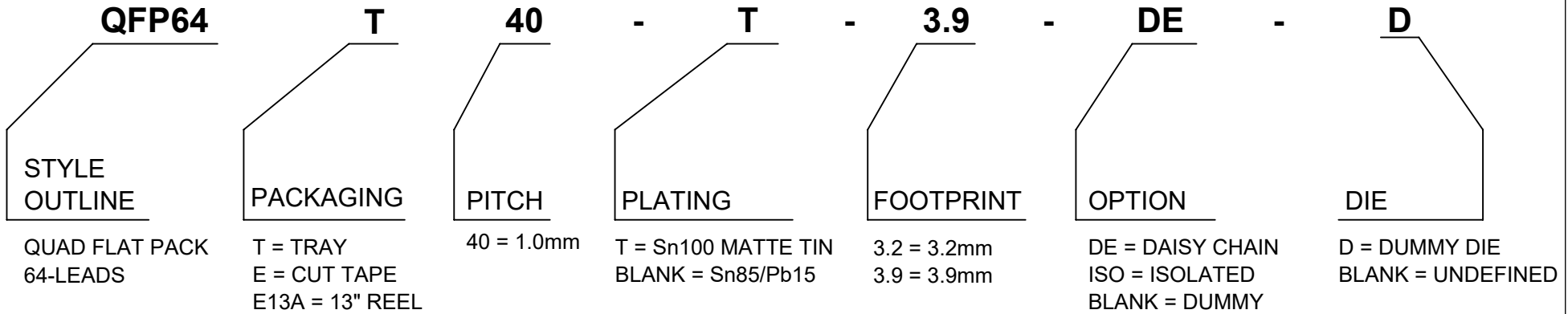

PART NUMBER	DAISY CHAIN	PACKAGING	RoHS Pb-FREE	PLATING	DUMMY DIE
QFP64T40-T-3.9-DE-D	YES	JEDEC TRAY	YES	Sn100	YES
QFP64E40-T-3.9-ISO	ISOLATED	JEDEC TRAY	YES	Sn100	NO
QFP64E40-T-3.9	NO	JEDEC TRAY	YES	Sn100	OPTIONAL
QFP64E13A40-T-3.9	NO	REEL	YES	Sn100	OPTIONAL
QFP64T40-3.9-DE-D	YES	JEDEC TRAY	NO	Sn85/Pb15	YES
QFP64T40-3.9	NO	JEDEC TRAY	NO	Sn85/Pb15	OPTIONAL

OTHER PART NUMBER COMBINATIONS AVAILABLE CONTACT TOPLINE.

TopLine®			
TITLE		QFP64T40-3.9 QUAD FLAT PLACK	
SCALE	SIZE	DRAWING NO.	REV
NONE	A	181640	A
DO NOT SCALE DRAWING			SHEET 4 OF 4