

SECTION A-A
SCALE 4 : 1

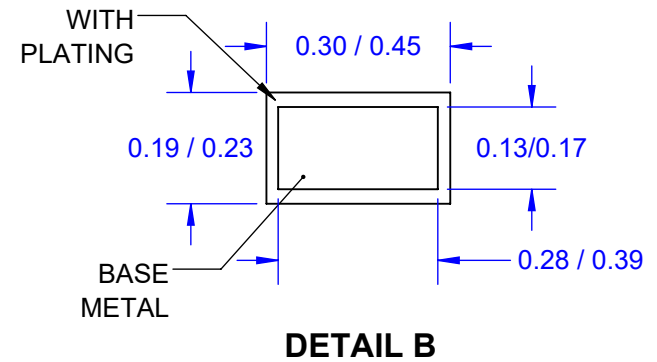
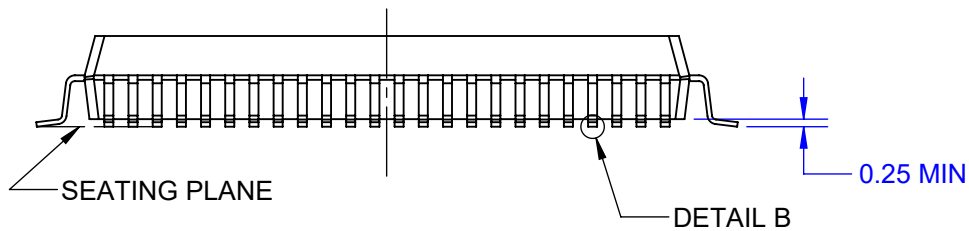
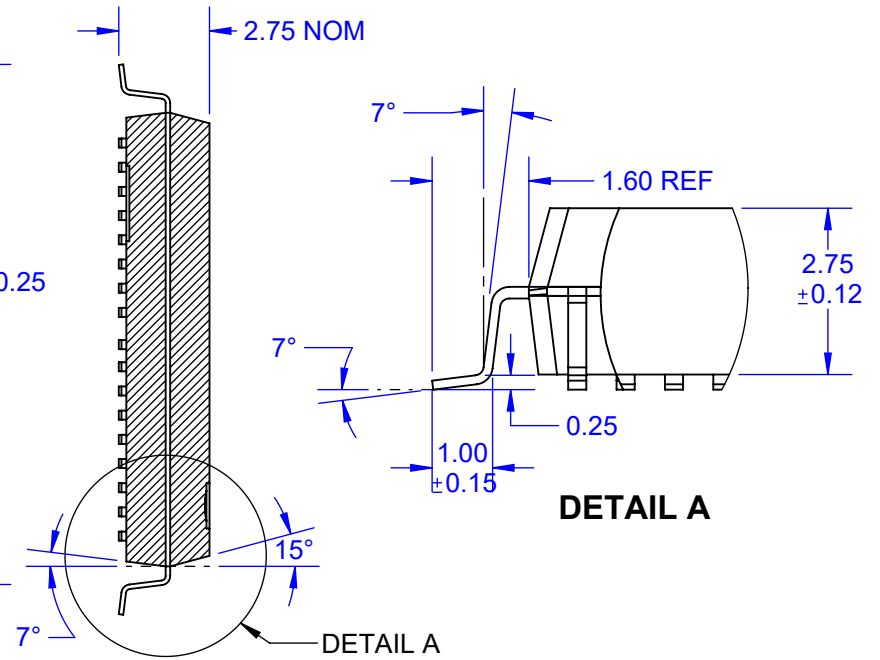

Notes: (Unless Otherwise Specified)

- 1) DIMENSIONS mm.
- 2) BODY PLASTIC, SEMICONDUCTOR GRADE.
- 3) LEAD FRAME COPPER. C-194 F/H.

APPROVALS	DATE	TopLine®			
DRAWN T. Au	9/12/2024				
ENG M. Hart	9/12/2024	TITLE QFP80T30-3.2 QUAD FLAT PACK			
MFG		SCALE	SIZE	DRAWING NO.	REV
QA		4:1	A	181081	A
CUST		DO NOT SCALE DRAWING			SHEET 1 OF 4
REVISED					

MODEL

TOP

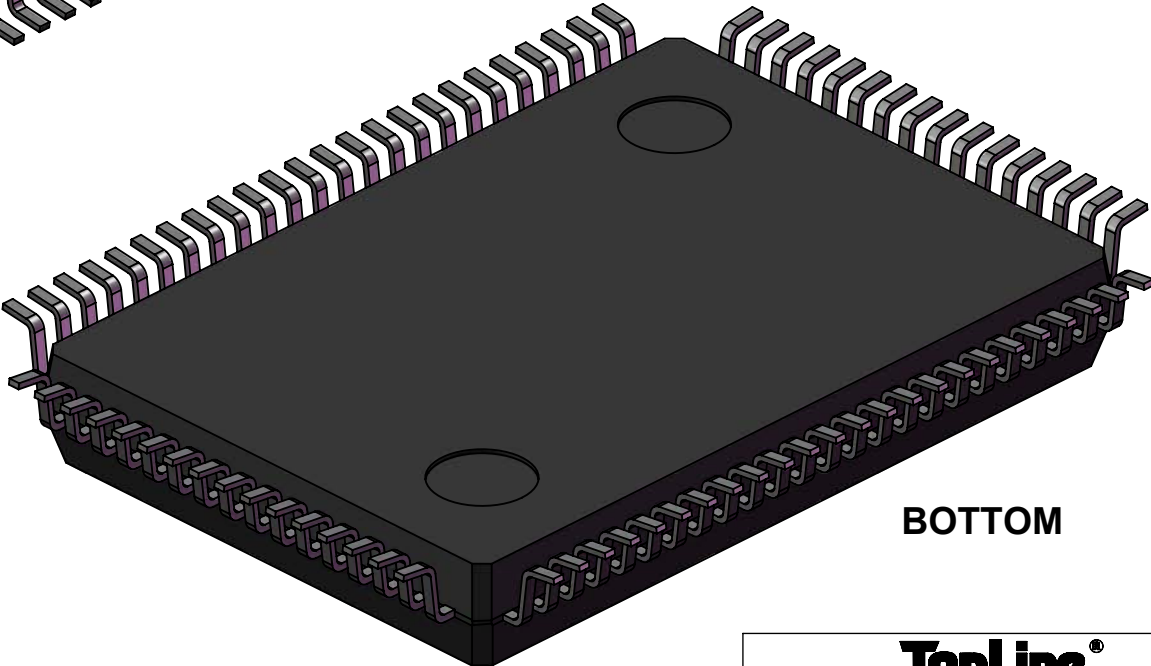
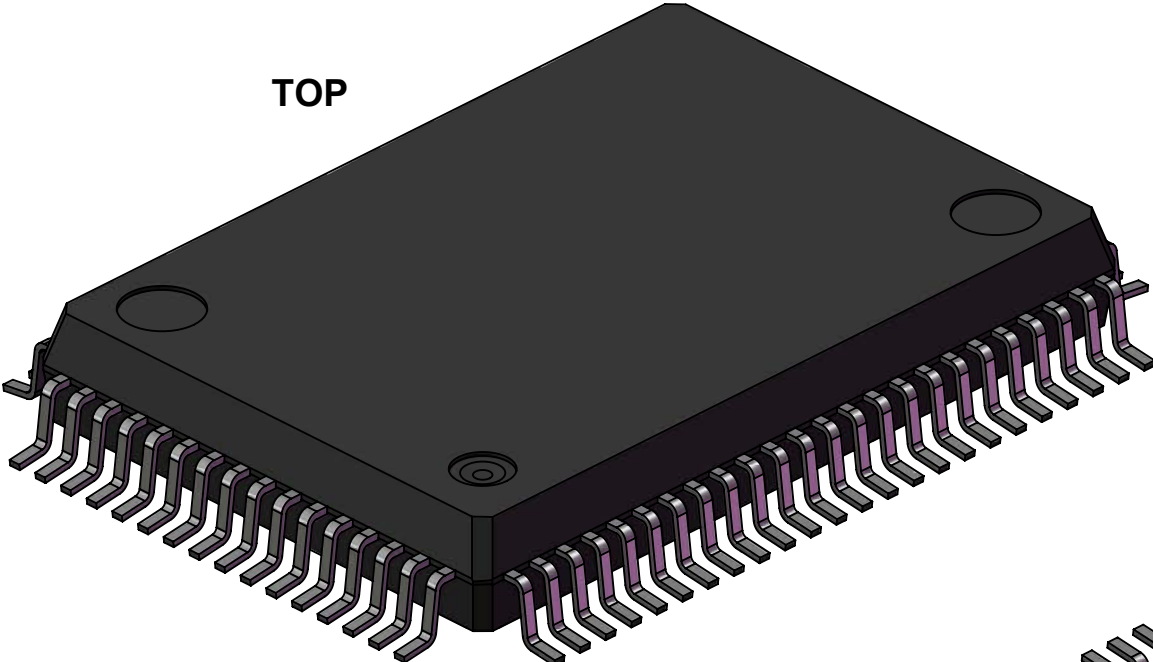

BOTTOM

TopLine[®]			
TITLE		QFP80T30-3.2 QUAD FLAT PACK	
SCALE	SIZE	DRAWING NO.	REV
6:1	A	181081	A
DO NOT SCALE DRAWING			SHEET 2 OF 4

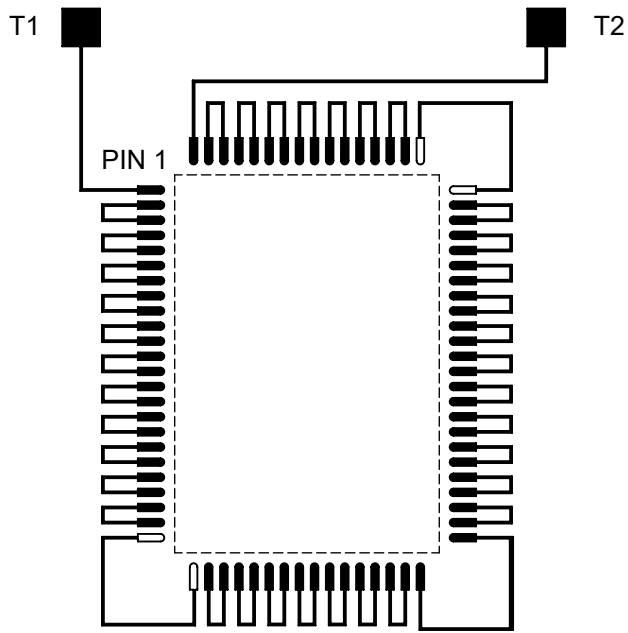

**RECOMMENDED
PCB PADS**

**DAISY CHAIN
OPTIONAL**

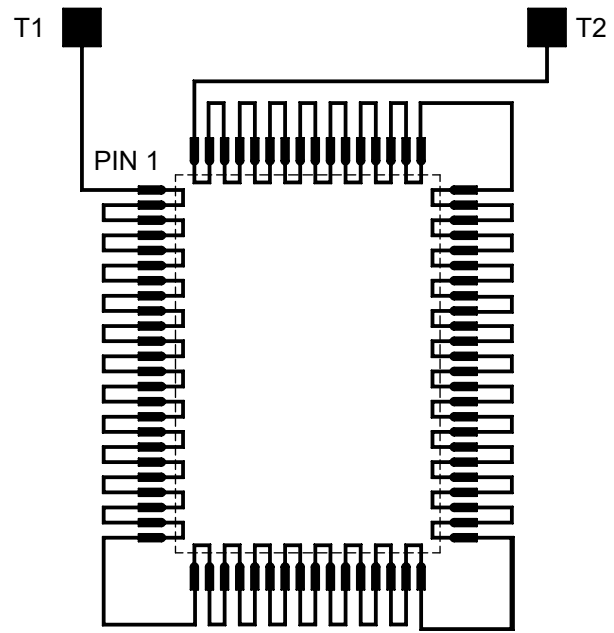

**AFTER MOUNTING
ON PCB**

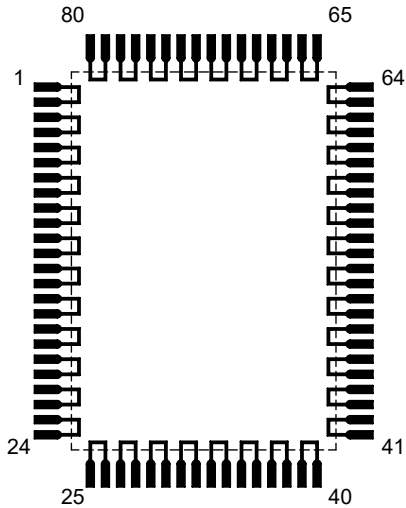

VIEW FROM TOP

DAISY CHAIN NET LIST			
PINS	PINS	PINS	PINS
1 ~ 2	21 ~ 22	41 ~ 42	61 ~ 62
3 ~ 4	23 ~ 24	43 ~ 44	63 ~ 64
5 ~ 6	25 ~ 26	45 ~ 46	65 ~ 66
7 ~ 8	27 ~ 28	47 ~ 48	67 ~ 68
9 ~ 10	29 ~ 30	49 ~ 50	69 ~ 70
11 ~ 12	31 ~ 32	51 ~ 52	71 ~ 72
13 ~ 14	33 ~ 34	53 ~ 54	73 ~ 74
15 ~ 16	35 ~ 36	55 ~ 56	75 ~ 76
17 ~ 18	37 ~ 38	57 ~ 58	77 ~ 78
19 ~ 20	39 ~ 40	59 ~ 60	79 ~ 80

TopLine®			
TITLE QFP80T30-3.2 QUAD FLAT PACK			
SCALE 2.5:1	SIZE A	DRAWING NO. 181081	REV A
DO NOT SCALE DRAWING			SHEET 3 OF 4

PART NUMBERING SYSTEM

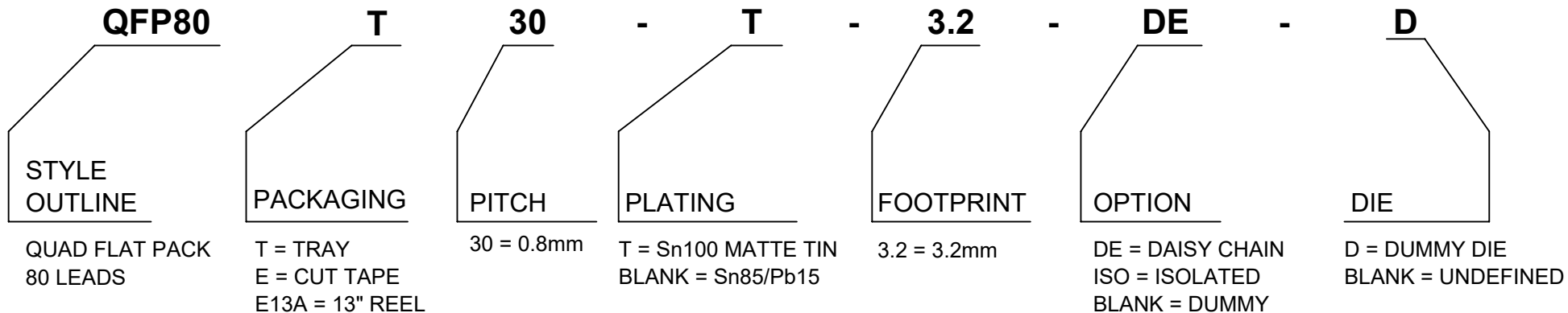

PART NUMBER	DAISY CHAIN	PACKAGING	RoHS Pb-FREE	PLATING	DUMMY DIE
QFP80T30-T-3.2-DE-D	YES	JEDEC TRAY	YES	Sn100	YES
QFP80T30-T-3.2-ISO	ISOLATED	JEDEC TRAY	YES	Sn100	NO
QFP80T30-T-3.2	NO	JEDEC TRAY	YES	Sn100	OPTIONAL
QFP80E30-T-3.2	NO	REEL	YES	Sn100	OPTIONAL
QFP80T30-3.2	NO	JEDEC TRAY	NO	Sn85/Pb15	YES
QFP80E30-3.2	NO	REEL	NO	Sn85/Pb15	OPTIONAL

OTHER PART NUMBER COMBINATIONS AVAILABLE CONTACT TOPLINE.

TopLine®			
TITLE		QFP80T30-3.2 QUAD FLAT PACK	
SCALE	SIZE	DRAWING NO.	REV
NONE	A	181081	A
DO NOT SCALE DRAWING			SHEET 4 OF 4