

TOP VIEW

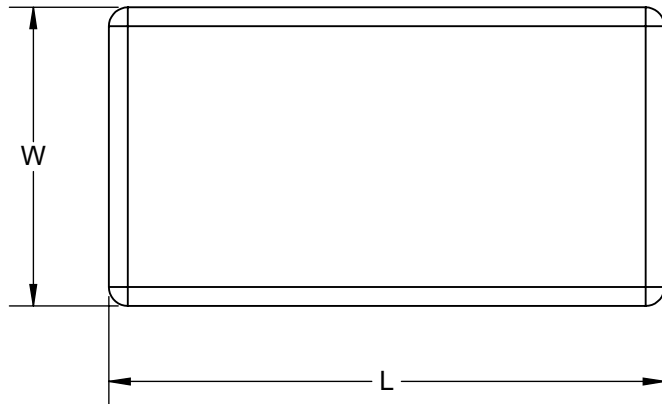

SIDE VIEW

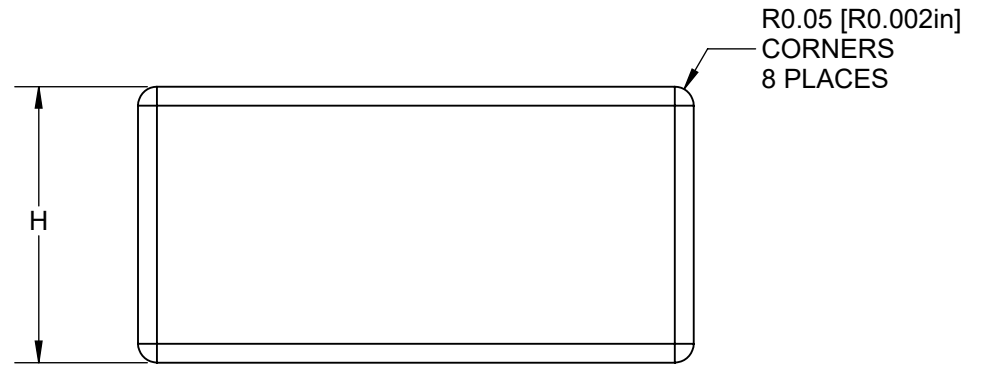

MODEL

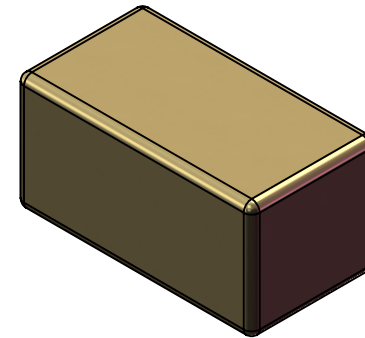

GOLD

SIZE				METRIC INCH
L LENGTH	W WIDTH	H HEIGHT	TOLERANCE	
1.60	0.89	0.89	±0.076	MM
0.063	0.035	0.035	±0.003	INCH

NOTES:

1. DIMENSION IN mm [INCH].
2. METALIZATION: Ni 140~180 Micro-Inch Au 25~43 Micro-Inch.
3. Pb-FREE AND HALOGEN FREE.
4. CORE MATERIAL: Al₂O₃ CERAMIC.

APPROVALS	DATE	TopLine®			
DRAWN T.Au	03/07/2020				
ENG M. Hart	03/07/2020	TITLE SS0603-GOLD METALLIZED CHIP JUMPER			
MFG		SCALE	SIZE	DRAWING NO.	REV
QA		40:1	A	060305	A
CUST		DO NOT SCALE DRAWING			SHEET 1 OF 2
REVISED					

W8P4 CARRIER TAPE DIMENSION

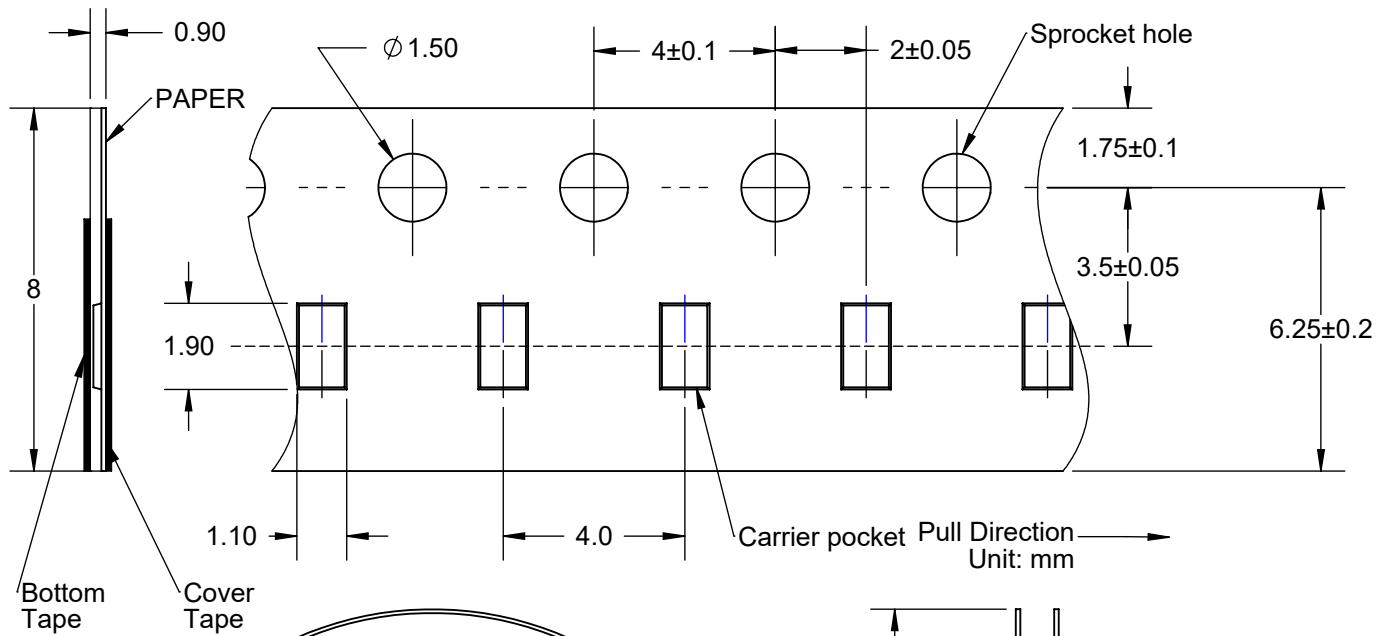

PART NUMBER SYSTEM

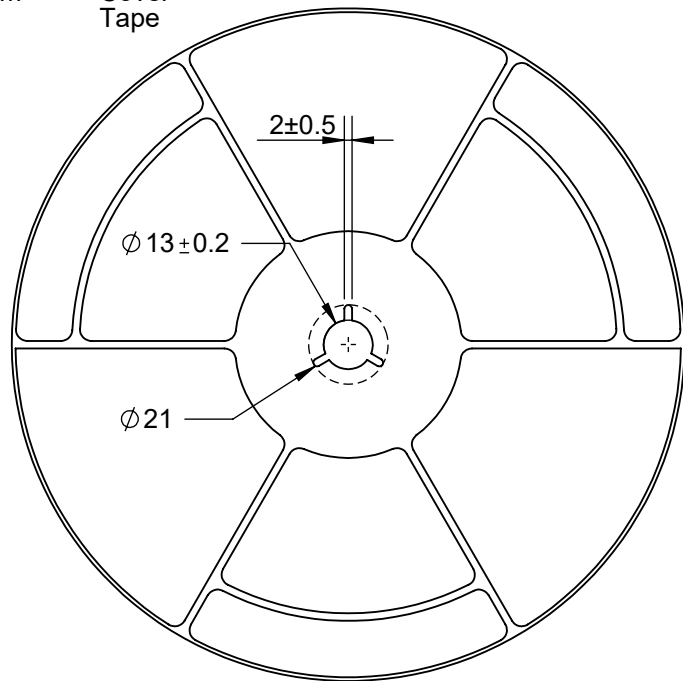
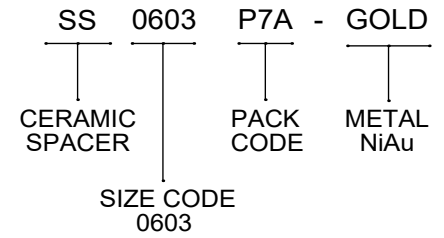

REEL DIMENSIONS

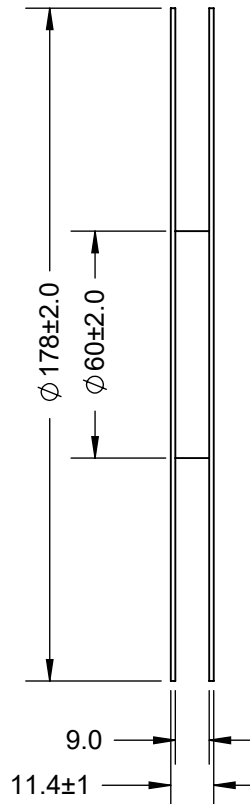

PACK CODE			
CODE	QTY	PACKAGE	TAPE
P7A	4,000	REEL	PAPER

TopLine®			
TITLE		SS0603-GOLD METALLIZED CHIP JUMPER	
SCALE	SIZE	DRAWING NO.	REV
NONE	A	060305	A
DO NOT SCALE DRAWING			SHEET 2 OF 2